

VIBIA

VIBIA

Recommended sales prices - vat not included this price list updates models and finishes in production, which may differ from photographs published in catalogue

Index

- Africa
264
 - Algorithm Grid
68
 - Algorithm Free
62
 - Alpha
396
 - Array
112
 - Balance
236
 - Bamboo
218
 - Big
54
 - Big Built-in
58
 - Break
188
 - Break Plus
190
 - Brisa
206
 - Class
166
 - Cosmos
156
 - Dama
170
 - Domo
400
 - Dots
208
 - Dots Outdoor
212
 - Duo
222
 - Empty
192
 - Flamingo
96
 - Flamingo Mini
100
 - Flat
292
 - Fold Surface
194
 - Funnel
122
 - Ghost
232
 - Guise
130
 - Halo Circular
138
 - Halo Lineal
142
 - Halo Jewel
146
 - Halo Wall
154
 - I. Cono
60
 - Jazz
94
 - June
216
 - Knit
380
 - Kontur
356
 - Match
404
 - Mayfair
256
 - Mayfair Mini
254
 - Meridiano
214
 - Musa
378
 - North
266
 - Origami
200
 - Out
196
 - Palma
174
 - Palo Alto
204
 - Pin
104
 - Plis Outdoor
182
 - Plusminus
328
 - Puck
238
 - Puck Wall Art
242
 - Quadra Ice
90
 - Rhythm Horizontal
124
 - Rhythm Vertical
128
 - Set
390
 - Skan
10
 - Slim
80
 - Spa
306
 - Sticks Connectable
362
 - Sticks Stand-alone
376
 - Structural
160
 - Suite
312
 - Tempo
280
 - Top
92
 - Tube
320
 - Up
198
 - Vol
8
 - Warm
226
 - Wind
184
 - Wireflow
20
 - Wireflow Chandelier
50
 - Wireflow Freeform
36
 - Wireflow Lineal
32
 - 45°
402
-
- Bulbs
408
 - Professional
area at vibia.com
409
 - Item coding
6
 - Glossary
410
 - Lighting control
systems
411

Item coding

Some pendant models offer different electrical connection typology, these will require additional coding.

ITEM CODING

Reference

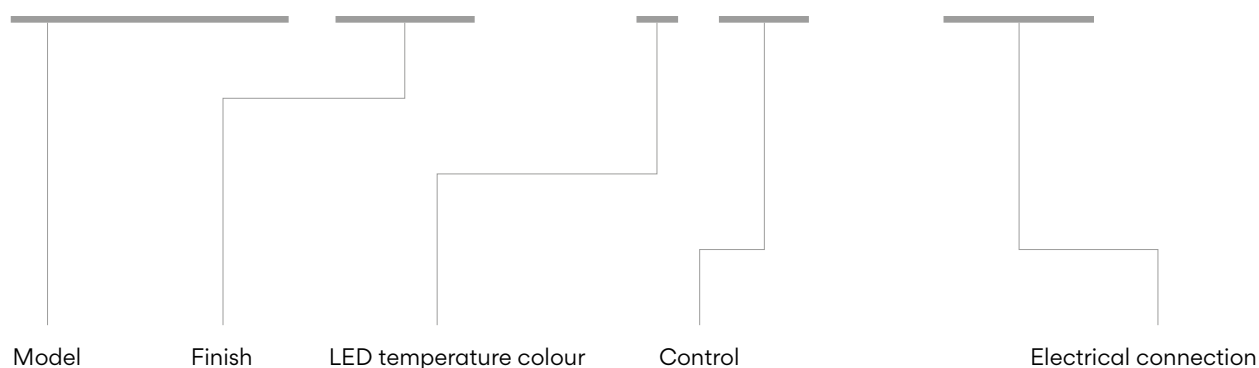

Model

Finish

LED temperature colour

Control

Electrical connection

4 digits

2 digits

1 digit

1 digit

2 digits

Type

Model

- 0 Without LED
- 1 2700 K
- 2 3000 K
- 3 3500 K
- 4 4000 K
- 7 2200 K

- 0 On/ Off
- 1 DALI
- 2 0-10V
- 3 1-10V
- 4 TRIAC
- 5 Push
- 6 Sensor
- A 1+3+5 (DALI + 1-10V + Push)
- B 3+5 (1-10V + Push)
- C 1+3 (DALI + 1-10V)
- E Casambi P2P + On/ Off
- F Simultaneous line DALI + 1-10V + Push + Casambi
- Z Casambi *
- M Without driver

- 1 Surface
- 2 Built-in
- 3 Remote
- 4 Bolt-down

- 0 Basic
- 1 Micro
- 2 XXS
- 3 XS
- 4 S
- 5 M
- 6 L
- 8 Free wire
- 9 Mud kit

* Casambi refers to wireless dimming solutions. Ask for more information.

Should you need a non-standard product. Please, request sales conditions.

Over the course of this year we shall proceed to standardise our finish codes.



Vol

Design by Lievore, Altherr, Molina

Vol combines traditional techniques and cutting-edge lighting capabilities. Smooth and streamlined, the simple oval forms create a delicate focal point in a space.

Pendants

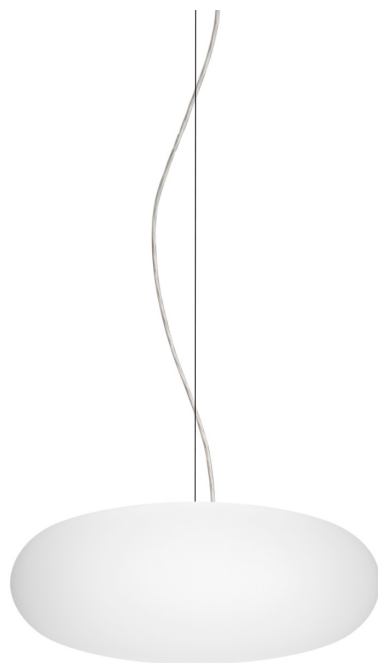

ø 60 cm

0225

0225

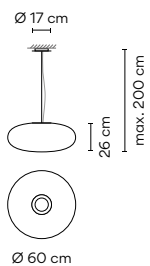

Finishes
● **03 White**
(RAL 9016)

LED temperature colour
2700 K 800 lm/W

0225 03

Materials
Shade: Glass. Disc: Aluminum.

Light Source and electronics
4 x LED E27 230V 9 W

Packaging
1 Box 0,78 x 0,78 x 0,50 m
Vol 0,3000 m³
Gross weight 11 Kg Net weight 9 Kg

Notes

Extra cable length.

UNTIL STOCK RUNS OUT



1160 10 /1A
Model Finish
LED temperature colour
Control



Skán

Design by Lievore, Altherr, Molina

Minimal volume and maximum lighting functionality. Skán represents a return to what is essential: pure, delicate lines in which the light is the fundamental element while the shape is almost invisible.

Floor

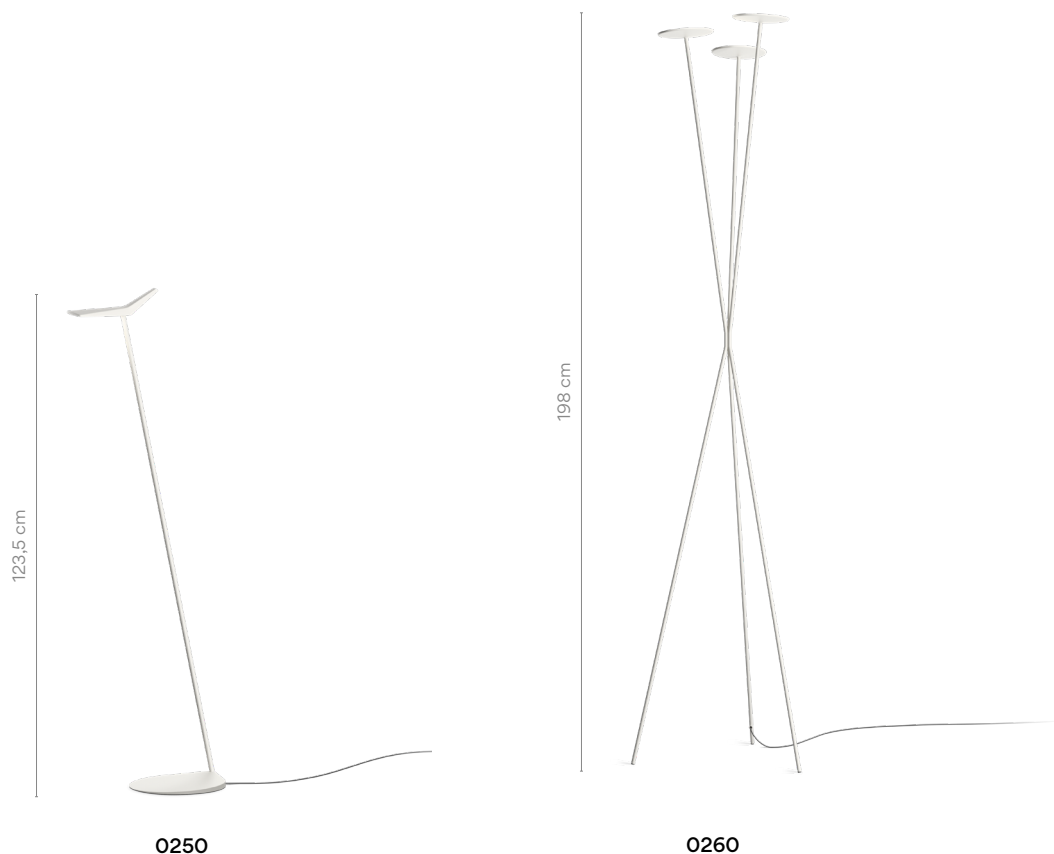

0250

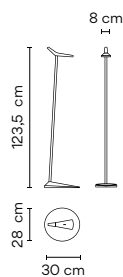

Finishes

- 10/ _ _ White (NCS S 0300-N)
- 11/ _ _ Black (NCS S 8500-N)
- 37/ _ _ Terra Red (NCS S4040-Y70R)

Finish customization
(Available options:
Vibia colour palette)

Materials

Head: Aluminum. Diffuser: Methacrylate.
Base: Zamak.

Light Source and electronics

1 x LED PLATE 24V 8 W
Constant Voltage 24V
110-240V 50/60Hz

LED temperature colour

/2 _ 3000 K
CRI >80 339,2 lm 42,4 lm/W

Control

0250 _ _ / _ 6
Optical Sensor

Packaging

1 Box 1,50 x 0,34 x 0,32 m
Vol 0,0418 m³
Gross weight 6 Kg Net weight 3 Kg

Notes

UNTIL STOCK RUNS OUT



Dimmer Bi-volt



0260

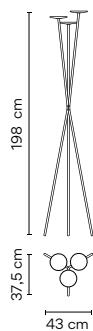

Finishes

- 10/ __ White (NCS S 0300-N)
- 11/ __ Black (NCS S 8500-N)
- 37/ __ Terra Red (NCS S4040-Y70R)

Finish customization
 (Available options:
 Vibia colour palette)

LED temperature colour

- /1 _ 2700 K CRI >90 4430,16 lm 159 lm/W
- /2 _ 3000 K E CRI >90 3792,73 lm 136 lm/W
- /3 _ 3500 K D CRI >90 4799,9 lm 172,0 lm/W

Control

0260 __ / _ 5
 Push

Materials

Head: Aluminum. Diffuser: Methacrylate.
 Vertical tube: Steel.

Light Source and electronics

3 x LED 9,2 W 500 mA
 Constant Current 500 mA
 110-240V 50/60Hz

Packaging

1 Box 2,11 x 0,60 x 0,60 m
 Vol 0,7596 m³
 Gross weight 5,4 Kg Net weight 2,5 Kg

LED IP20 CE EAC
 Dimmer Bi-volt

Pendants

0270

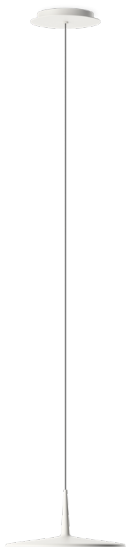

ø 30 cm

0271

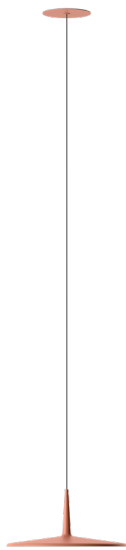

ø 30 cm

0275

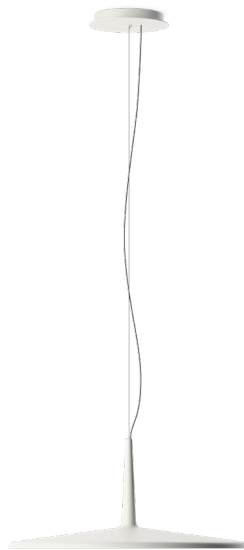

ø 60 cm

0276

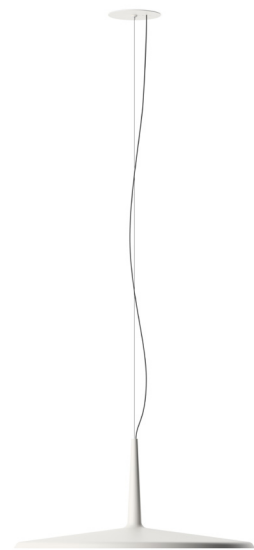

ø 60 cm

0280

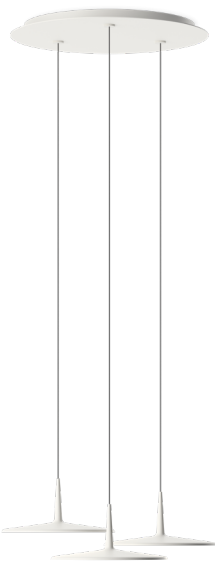

ø 30 cm

0282



ø 30 cm

0270

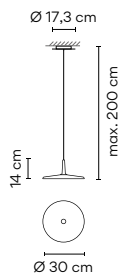

- Finishes**
- 10/ __ White (NCS S 0300-N)
 - 11/ __ Black (NCS S 8500-N)
 - 24/ __ Beige M1 (NCS S 2005-Y50R)
 - 37/ __ Terra Red (NCS S4040-Y70R)
 - 42/ __ Blue M1 (NCS S 5010-B10G)
 - 47/ __ Green L1 (NCS S 4005-G80Y)
- Finish customization**
(Available options: Vibia colour palette)

- LED temperature colour**
- /1_ 2700 K D CRI >90 1269 lm 141 lm/W
 - /2_ 3000 K D CRI >80 1123 lm 125 lm/W
 - /3_ 3500 K G CRI >90 1374,9 lm 152,8 lm/W

- Control**
- 0270 __ / _ 1 DALI-2
 - 0270 __ / _ 2 0-10V
 - 0270 __ / _ Z Casambi

Materials

Body: Aluminum. Diffuser: Methacrylate.
Canopy Plate: Steel.

Light Source and electronics

1 x LED 9,3 W 350 mA
Constant Current 350 mA
110-277V 50/60Hz

Packaging

1 Box 0,29 x 0,38 x 0,38 m
Vol 0,0418 m³
Gross weight 2,6 Kg Net weight 1,4 Kg

Notes

Surface.
Extra cable length.



0271

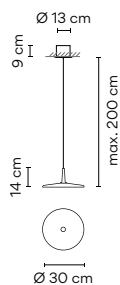

- Finishes**
- 10/ __ White (NCS S 0300-N)
 - 11/ __ Black (NCS S 8500-N)
 - 24/ __ Beige M1 (NCS S 2005-Y50R)
 - 37/ __ Terra Red (NCS S4040-Y70R)
 - 42/ __ Blue M1 (NCS S 5010-B10G)
 - 47/ __ Green L1 (NCS S 4005-G80Y)
- Finish customization**
(Available options: Vibia colour palette)

- LED temperature colour**
- /1_ 2700 K D CRI >90 1269 lm 141 lm/W
 - /2_ 3000 K D CRI >80 1269 lm 125 lm/W
 - /3_ 3500 K G CRI >90 1374,9 lm 152,8 lm/W

- Control**
- 0271 __ / _ 1 DALI
 - 0271 __ / _ B 1-10V, Push
 - 0271 __ / _ Z Casambi

Materials

Body: Aluminum. Diffuser: Methacrylate.
Canopy Plate: Steel.

Light Source and electronics

1 x LED 9,3 W 350 mA
Constant Current 350 mA
110-240V 50/60Hz

Packaging

1 Box 0,29 x 0,38 x 0,38 m
Vol 0,0418 m³
Gross weight 2,5 Kg Net weight 1,4 Kg

Notes

Built-in.
Extra cable length.

UNTIL STOCK RUNS OUT

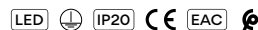

Bi-volt A ø 11,5 cm

Electrical connection

- Surface
- _18 Free Wire
- _23 Built-in
- _31 Remote Micro for plaster ceilings
- _32 Remote XXS for all types of drop ceilings

0275

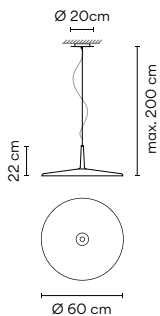

- Finishes**
- 10/ __ White (NCS S 0300-N)
 - 11/ __ Black (NCS S 8500-N)
 - 24/ __ Beige M1 (NCS S 2005-Y50R)
 - 37/ __ Terra Red (NCS S4040-Y70R)
 - 42/ __ Blue M1 (NCS S 5010-B10G)
 - 47/ __ Green L1 (NCS S 4005-G80Y)
- Finish customization**
(Available options:
Vibia colour palette)

- LED temperature colour**
- /1_ 2700 K CRI >90 1269 lm 91 lm/W
 - /2_ 3000 K CRI >80 1575 lm 113 lm/W
 - /3_ 3500 K CRI >90 1375,3 lm 98,9 lm/W

- Control**
- 0275 __ / _ 1 DALI-2
 - 0275 __ / _ B 1-10V, Push
 - 0275 __ / _ Z Casambi

Materials
Body: Aluminum. Diffuser: Methacrylate.
Canopy Plate: Steel.

Light Source and electronics
1 x LED 13,9 W 500 mA
Constant Current 500 mA
110-240V 50/60Hz

Packaging
1 Box 0,42 x 0,71 x 0,66 m
Vol 0,2000 m³
Gross weight 7 Kg Net weight 4,4 Kg

Notes
Surface.
Extra cable length.



0276

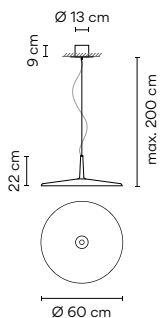

- Finishes**
- 10/ __ White (NCS S 0300-N)
 - 11/ __ Black (NCS S 8500-N)
 - 24/ __ Beige M1 (NCS S 2005-Y50R)
 - 37/ __ Terra Red (NCS S4040-Y70R)
 - 42/ __ Blue M1 (NCS S 5010-B10G)
 - 47/ __ Green L1 (NCS S 4005-G80Y)
- Finish customization**
(Available options:
Vibia colour palette)

- LED temperature colour**
- /1_ 2700 K CRI >90 1269 lm 91 lm/W
 - /2_ 3000 K CRI >80 1575 lm 113 lm/W
 - /3_ 3500 K CRI >90 1375,3 lm 98,9 lm/W

- Control**
- 0276 __ / _ 1 DALI-2
 - 0276 __ / _ B 1-10V, Push
 - 0276 __ / _ Z Casambi

Materials
Body: Aluminum. Diffuser: Methacrylate.
Canopy Plate: Steel.

Light Source and electronics
1 x LED 13,9 W 500 mA
Constant Current 500 mA
110-240V 50/60Hz

Packaging
1 Box 0,42 x 0,71 x 0,66 m
Vol 0,2000 m³
Gross weight 7 Kg Net weight 4,4 Kg

Notes
Suitable for built-in and surface fitting.
Extra cable length.

UNTIL STOCK RUNS OUT

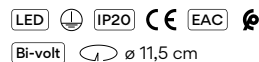

0280

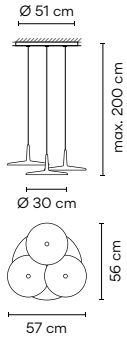

Finishes

- 10/ __ White (NCS S 0300-N)
- 11/ __ Black (NCS S 8500-N)
- 24/ __ Beige M1 (NCS S 2005-Y50R)
- 37/ __ Terra Red (NCS S4040-Y70R)
- 42/ __ Blue M1 (NCS S 5010-B10G)
- 47/ __ Green L1 (NCS S 4005-G80Y)

Finish customization
 (Available options:
 Vibia colour palette)

LED temperature colour

- /1_ 2700 K CRI >90 3123 lm 112 lm/W
- /2_ 3000 K CRI >80 3369 lm 121 lm/W
- /3_ 3500 K CRI >90 4124,7 lm 147,8 lm/W

Control

- 0280 __ / _ 1 DALI-2
- 0280 __ / _ B 1-10V, Push
- 0280 __ / _ Z Casambi

Materials

Body: Aluminum. Diffuser: Methacrylate.
 Canopy Plate: Steel.

Light Source and electronics

3 x LED 9,3 W 350 mA
 Constant Current 350 mA
 110-240V 50/60Hz

Packaging

2 Boxes
 Total Vol 0,2226 m³
 Gross weight 13,7 Kg Net weight 9,2 Kg

Notes

Surface.
 Extra cable length.



0282

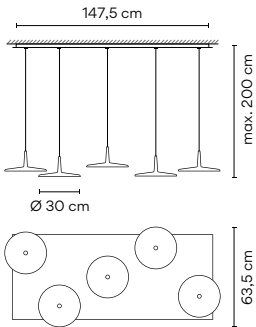

Finishes

- 10/ __ White (NCS S 0300-N)
- 11/ __ Black (NCS S 8500-N)
- 24/ __ Beige M1 (NCS S 2005-Y50R)
- 37/ __ Terra Red (NCS S4040-Y70R)
- 42/ __ Blue M1 (NCS S 5010-B10G)
- 47/ __ Green L1 (NCS S 4005-G80Y)

Finish customization
 (Available options:
 Vibia colour palette)

LED temperature colour

- /1_ 2700 K CRI >90 5205 lm 112 lm/W
- /2_ 3000 K CRI >80 5615 lm 121 lm/W
- /3_ 3500 K CRI >90 6874,5 lm 147,8 lm/W

Control

- 0282 __ / _ 1 DALI-2
- 0282 __ / _ B 1-10V, Push
- 0282 __ / _ Z Casambi

Materials

Body: Aluminum. Diffuser: Methacrylate.
 Canopy Plate: Steel.

Light Source and electronics

5 x LED 9,3 W 350mA
 Constant Current 350 mA
 110-240V 50/60Hz

Packaging

2 Boxes
 Total Vol 0,3290 m³
 Gross weight 36,9 Kg Net weight 29 Kg

Notes

Surface.
 Extra cable length.



Composing pendants

Next sketches are composed by one or more compositions

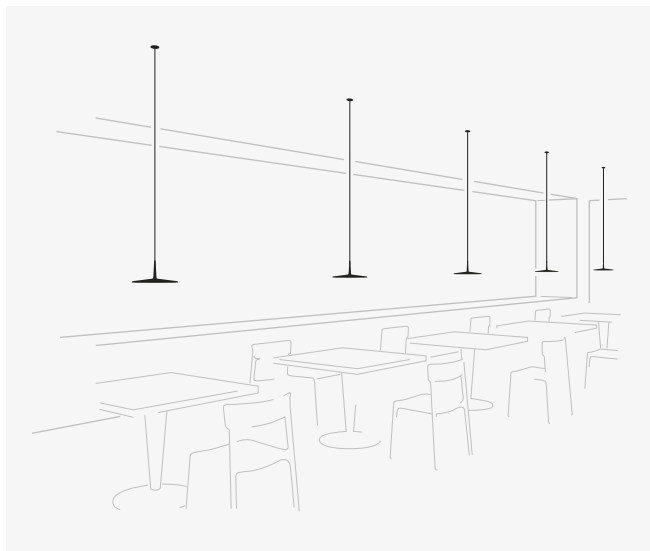

5 x 0270.

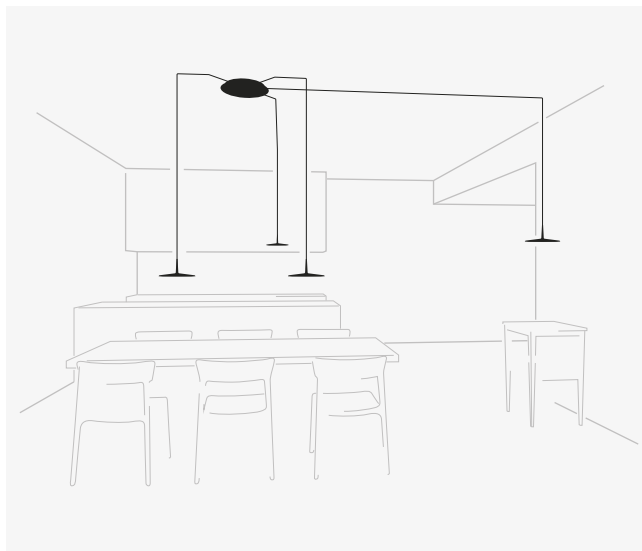

4 x 0270.

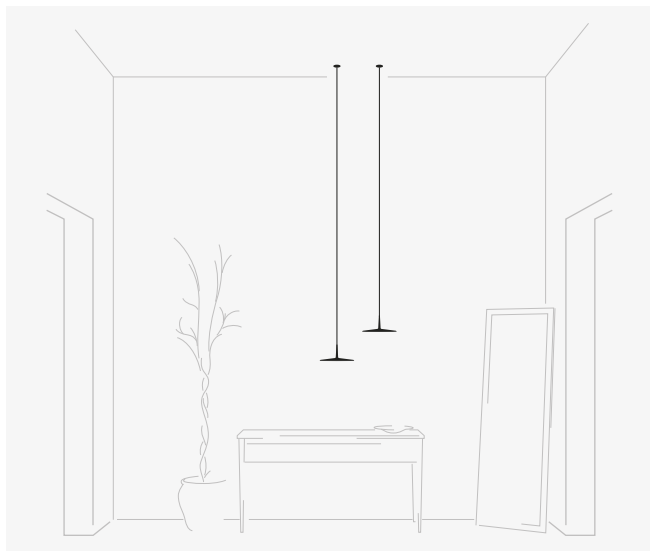

2 x 0270.

Each project is unique.
Visit vibia.com and
chose among multiple
compositions designed
and adapted to your
project needs.

Personalise your own
Skan composition quick
and easy at vibia.com

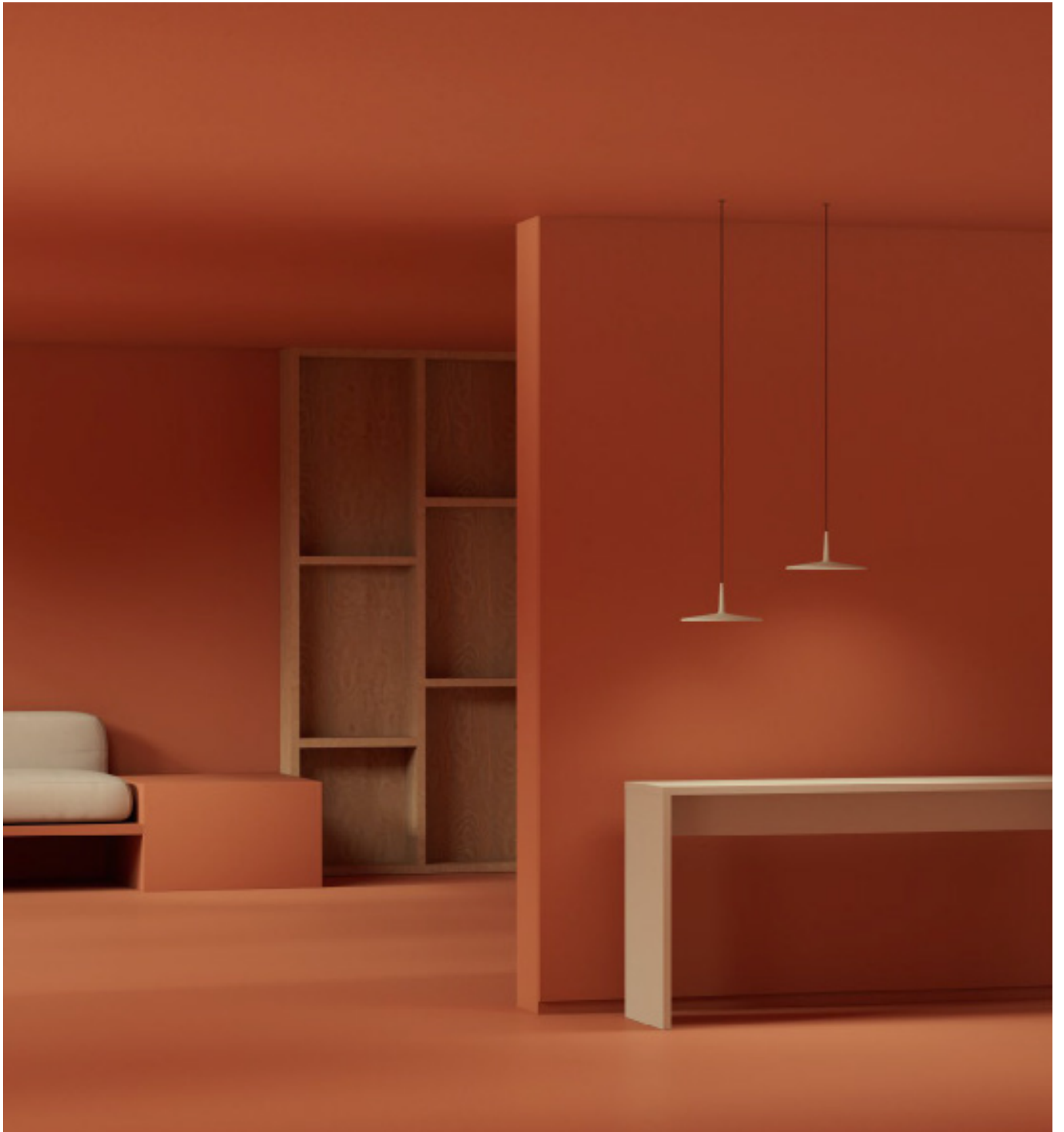

Electrical connection options for model 0270

Choose your preferred installation option according to your needs. For each composition, the optimal minimum number of drivers will be delivered.

Drop ceiling

The innovative remote and built-in fittings accentuate the silkiness and lightness of compositions on suspended ceilings, its great visual grandeur taking center stage.

For Ref. 0270

Remote

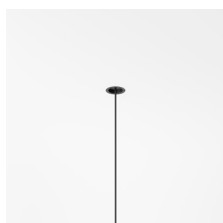

Micro \varnothing 3 cm
height 7 cm
for plaster ceilings.
Black finish.

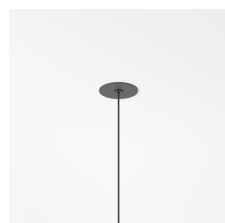
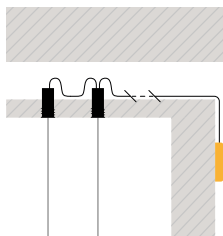

XXS \varnothing 6 cm
height 6 cm
for all types of drop
ceilings. Match with
fixture finish.

Built-in



\varnothing 8 cm
height 6 cm
match with
fixture finish.

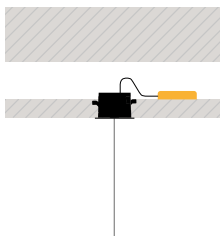

Regular ceiling

When architecture does not allow for performance, surface and free wire showcase possibilities for any need or desire with no limits, ideal for both individual or cluster arrangements.

For Ref. 0270

Surface

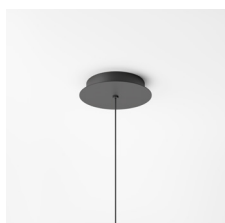

ø 17,3 cm
match with
fixture finish.

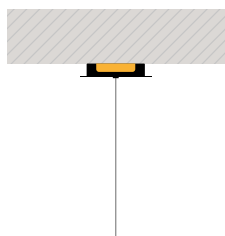

Free Wire

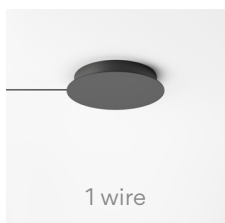

1 wire

ø 20 cm

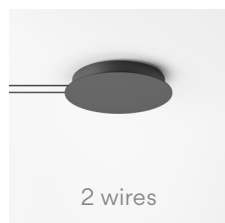

2 wires

ø 22 cm

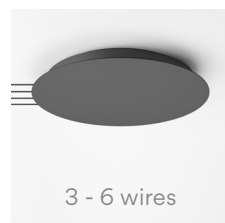

3 - 6 wires

ø 36 cm

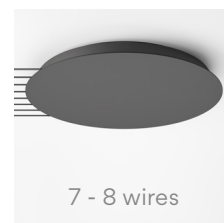

7 - 8 wires

ø 40 cm

you can choose the finish of the canopy
among black, white or any colour
matching one of the pendants.

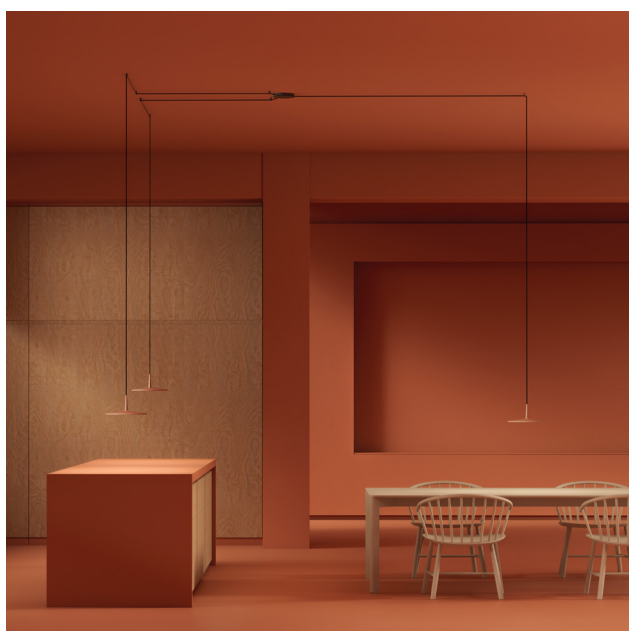
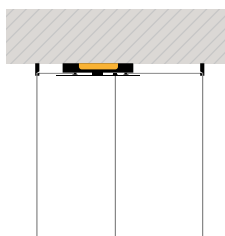

Wireflow

Design by Arik Levy

Crafted of black, electrical cables, Volumetric's airy, three-dimensional outline lends it the feeling of being at once present and absent. The geometric volumes are tipped with LED light terminals in a contemporary take on the traditional chandelier.



Each project is unique. Visit vibia.com and chose among multiple compositions designed and adapted to your project needs.

Personalise your own Wireflow composition quick and easy at vibia.com

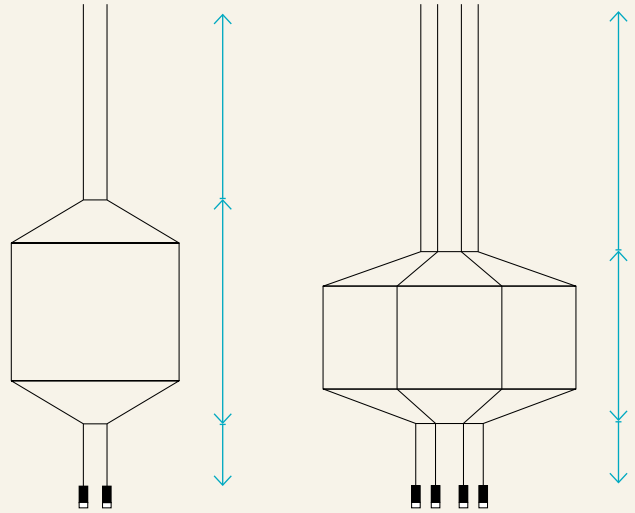

Pressed-glass diffuser.
 *Without pressed-glass diffuser.

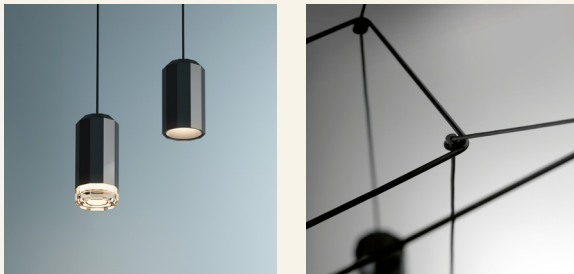

0299

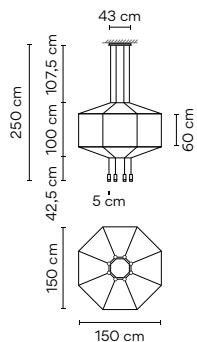

Finishes
 ● 04/ __ Black (RAL 9005)

LED temperature colour
 /1 _ 2700 K [D] CRI >90 3880 lm 121 lm/W
 /2 _ 3000 K [E] CRI >90 3880 lm 121 lm/W
 /3 _ 3500 K [E] CRI >90 4002,4 lm 125,1 lm/W

Control
 0299 __ / _ A DALI-2, 1-10V, Push
 0299 __ / _ Z Casambi

Materials
 Diffuser: Pressed-glass. Horizontal rods: Steel.
 Body: Aluminum Canopy: Steel.

Light Source and electronics
 8 x LED 4,5 W 350 mA
 Constant Current 350 mA
 110-240V 50/60Hz

Packaging
 2 Boxes
 Total Vol 0,3245 m³
 Gross weight 20,6 Kg Net weight 9,6 Kg

Notes
 Pressed-glass diffuser.

Configuration layout at vibia.com
 Min. quantity, upcharge and extra lead time apply



0300

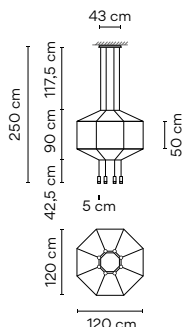

<p>Finishes</p> <p>● 04/ __ Black (RAL 9005)</p>	<p>LED temperature colour</p> <p>/1 _ 2700 K CRI >90 3880 lm 121 lm/W</p> <p>/2 _ 3000 K CRI >90 3880 lm 121 lm/W</p> <p>/3 _ 3500 K CRI >90 4002,4 lm 125,1 lm/W</p>	<p>Control</p> <p>0300 __ / __ A DALI-2, 1-10V, Push</p> <hr/> <p>0300 __ / __ Z Casambi</p>
--	---	---

<p>Materials</p> <p>Diffuser: Pressed-glass. Horizontal rods: Steel. Body: Aluminum Canopy: Steel.</p> <p>Light Source and electronics</p> <p>8 x LED 4,5 W 350 mA Constant Current 350 mA 110-240V 50/60Hz</p>	<p>Packaging</p> <p>2 Boxes Total Vol 0,3246 m³ Gross weight 19,95 Kg Net weight 8,95 Kg</p> <p>Notes</p> <p>Pressed-glass diffuser.</p> <p>Configuration layout at vibia.com Min. quantity, upcharge and extra lead time apply</p>
---	---



0301

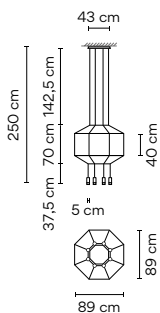

<p>Finishes</p> <p>● 04/ __ Black (RAL 9005)</p>	<p>LED temperature colour</p> <p>/1 _ 2700 K CRI >90 3880 lm 121 lm/W</p> <p>/2 _ 3000 K CRI >90 3880 lm 121 lm/W</p> <p>/3 _ 3500 K CRI >90 4002,4 lm 125,1 lm/W</p>	<p>Control</p> <p>0301 __ / __ A DALI-2, 1-10V, Push</p> <hr/> <p>0301 __ / __ Z Casambi</p>
--	---	---

<p>Materials</p> <p>Diffuser: Pressed-glass. Horizontal rods: Steel. Body: Aluminum Canopy: Steel.</p> <p>Light Source and electronics</p> <p>8 x LED 4,5 W 350 mA Constant Current 350 mA 110-240V 50/60Hz</p>	<p>Packaging</p> <p>2 Boxes Total Vol 0,2100 m³ Gross weight 17,75 Kg Net weight 8,75 Kg</p> <p>Notes</p> <p>Pressed-glass diffuser.</p> <p>Configuration layout at vibia.com Min. quantity, upcharge and extra lead time apply.</p>
---	--



0302

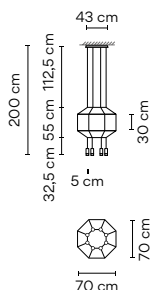

<p>Finishes</p> <p>● 04/ __ Black (RAL 9005)</p>	<p>LED temperature colour</p> <p>/1 _ 2700 K CRI >90 3880 lm 121 lm/W</p> <p>/2 _ 3000 K CRI >90 3880 lm 121 lm/W</p> <p>/3 _ 3500 K CRI >90 4002,4 lm 125,1 lm/W</p>	<p>Control</p> <p>0302 __ / __ A DALI-2, 1-10V, Push</p> <hr/> <p>0302 __ / __ Z Casambi</p>
--	---	---

<p>Materials</p> <p>Diffuser: Pressed-glass. Horizontal rods: Steel. Body: Aluminum Canopy: Steel.</p> <p>Light Source and electronics</p> <p>8 x LED 4,5 W 350 mA Constant Current 350 mA 110-240V 50/60Hz</p>	<p>Packaging</p> <p>2 Boxes Total Vol 0,1558 m³ Gross weight 14,6 Kg Net weight 8,6 Kg</p> <p>Notes</p> <p>Pressed-glass diffuser.</p> <p>Configuration layout at vibia.com Min. quantity, upcharge and extra lead time apply.</p>
---	--



0303

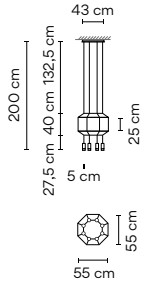

Finishes
 ● 04/ _ _ Black (RAL 9005)

LED temperature colour
 /1 _ 2700 K [D] CRI >90 3880 lm 121 lm/W
 /2 _ 3000 K [E] CRI >90 3880 lm 121 lm/W
 /3 _ 3500 K [E] CRI >90 4002,4 lm 125,1 lm/W

Control
 0303 _ _ / _ A DALI-2, 1-10V, Push
 0303 _ _ / _ Z Casambi

Materials
 Diffuser: Pressed-glass. Horizontal rods: Steel.
 Body: Aluminum Canopy: Steel.

Light Source and electronics
 8 x LED 4,5 W 350 mA
 Constant Current 350 mA
 110-240V 50/60Hz

Packaging
 2 Boxes
 Total Vol 0,1558 m³
 Gross weight 13 Kg Net weight 8,5 Kg

Notes
 Pressed-glass diffuser.
Configuration layout at vibia.com
 Min. quantity, upcharge and extra lead time apply.



0304

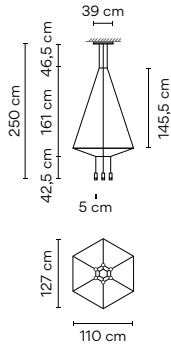

Finishes
 ● 04/ _ _ Black (RAL 9005)

LED temperature colour
 /1 _ 2700 K [D] CRI >90 2910 lm 121 lm/W
 /2 _ 3000 K [E] CRI >90 2910 lm 121 lm/W
 /3 _ 3500 K [E] CRI >90 3001,8 lm 125,1 lm/W

Control
 0304 _ _ / _ A DALI-2, 1-10V, Push
 0304 _ _ / _ Z Casambi

Materials
 Diffuser: Pressed-glass. Horizontal rods: Steel.
 Body: Aluminum Canopy: Steel.

Light Source and electronics
 6 x LED 4,5W 350 mA
 Constant Current 350 mA
 110-240V 50/60Hz

Packaging
 2 Boxes
 Total Vol 0,3245 m³
 Gross weight 15,55 Kg Net weight 5,65 Kg

Notes
 Pressed-glass diffuser.
Configuration layout at vibia.com
 Min. quantity, upcharge and extra lead time apply.

UNTIL STOCK RUNS OUT



0305

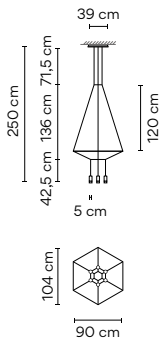

Finishes
 ● 04/ _ _ Black (RAL 9005)

LED temperature colour
 /1 _ 2700 K [D] CRI >90 2910 lm 121 lm/W
 /2 _ 3000 K [E] CRI >90 2910 lm 121 lm/W
 /3 _ 3500 K [E] CRI >90 3001,8 lm 125,1 lm/W

Control
 0305 _ _ / _ A DALI-2, 1-10V, Push
 0305 _ _ / _ Z Casambi

Materials
 Diffuser: Pressed-glass. Horizontal rods: Steel.
 Body: Aluminum Canopy: Steel.

Light Source and electronics
 6 x LED 4,5W 350 mA
 Constant Current 350 mA
 110-240V 50/60Hz

Packaging
 2 Boxes
 Total Vol 0,2100 m³
 Gross weight 13,2 Kg Net weight 3,5 Kg

Notes
 Pressed-glass diffuser.
Configuration layout at vibia.com
 Min. quantity, upcharge and extra lead time apply.

UNTIL STOCK RUNS OUT



0306

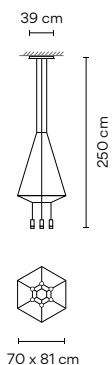

Finishes ● 04/ __ Black (RAL 9005)	LED temperature colour /1 _ 2700 K D CRI >90 2910 lm 121 lm/W
	/2 _ 3000 K E CRI >90 2910 lm 121 lm/W
	/3 _ 3500 K E CRI >90 3001,8 lm 125,1 lm/W

Control
0306 __ / __ A
 DALI-2, 1-10V, Push
0306 __ / __ Z
 Casambi

Materials
 Diffuser: Pressed-glass. Horizontal rods: Steel.
 Body: Aluminum Canopy: Steel.

Light Source and electronics
 6 x LED 4,5W 350 mA
 Constant Current 350 mA
 110-240V 50/60Hz

Packaging
 2 Boxes
 Total Vol 0,2100 m³
 Gross weight 13,1 Kg Net weight 5,2 Kg

Notes
 Pressed-glass diffuser.
Configuration layout at vibia.com
 Min. quantity, upcharge and extra lead time apply.

UNTIL STOCK RUNS OUT



0307

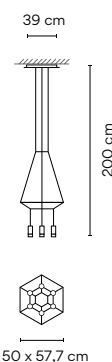

Finishes ● 04/ __ Black (RAL 9005)	LED temperature colour /1 _ 2700 K D CRI >90 2910 lm 121 lm/W
	/2 _ 3000 K E CRI >90 2910 lm 121 lm/W
	/3 _ 3500 K E CRI >90 3001,8 lm 125,1 lm/W

Control
0307 __ / __ A
 DALI-2, 1-10V, Push
0307 __ / __ Z
 Casambi

Materials
 Diffuser: Pressed-glass. Horizontal rods: Steel.
 Body: Aluminum Canopy: Steel.

Light Source and electronics
 6 x LED 4,5W 350mA
 Constant Current 350 mA
 110-240V 50/60Hz

Packaging
 2 Boxes
 Total Vol 0,1558 m³
 Gross weight 10 Kg Net weight 5,1 Kg

Notes
 Pressed-glass diffuser.
Configuration layout at vibia.com
 Min. quantity, upcharge and extra lead time apply.

UNTIL STOCK RUNS OUT



0308

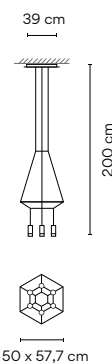

Finishes ● 04/ __ Black (RAL 9005)	LED temperature colour /1 _ 2700 K D CRI >90 2910 lm 121 lm/W
	/2 _ 3000 K E CRI >90 2910 lm 121 lm/W
	/3 _ 3500 K E CRI >90 3001,8 lm 125,1 lm/W

Control
0308 __ / __ A
 DALI-2, 1-10V, Push
0308 __ / __ Z
 Casambi

Materials
 Diffuser: Pressed-glass. Horizontal rods: Steel.
 Body: Aluminum Canopy: Steel.

Light Source and electronics
 6 x LED 4,5W 350mA
 Constant Current 350 mA
 110-240V 50/60Hz

Packaging
 2 Boxes
 Total Vol 0,1238 m³
 Gross weight 8,4 Kg Net weight 5 Kg

Notes
 Pressed-glass diffuser.
Configuration layout at vibia.com
 Min. quantity, upcharge and extra lead time apply.

UNTIL STOCK RUNS OUT



0309

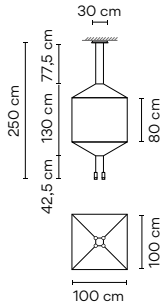

Finishes
 ● 04/ __ Black (RAL 9005)

LED temperature colour
 /1 _ 2700 K **D** CRI >90 1940 lm 121 lm/W
 /2 _ 3000 K **E** CRI >90 1940 lm 121 lm/W
 /3 _ 3500 K **E** CRI >90 2001,2 lm 125,1 lm/W

Control
 0309 __ / _ A DALI-2, 1-10V, Push
 0309 __ / _ Z Casambi

Materials
 Diffuser: Pressed-glass. Horizontal rods: Steel.
 Body: Aluminum Canopy: Steel.

Light Source and electronics
 4 x LED 4,5 W 350 mA
 Constant Current 350 mA
 110-240V 50/60Hz

Packaging
 2 Boxes
 Total Vol 0,2100 m³
 Gross weight 12,3 Kg Net weight 5,3 Kg

Notes
 Pressed-glass diffuser.
Configuration layout at vibia.com
 Min. quantity, upcharge and extra lead time apply.



0310

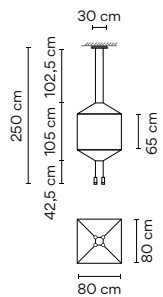

Finishes
 ● 04/ __ Black (RAL 9005)

LED temperature colour
 /1 _ 2700 K **D** CRI >90 1940 lm 121 lm/W
 /2 _ 3000 K **E** CRI >90 1940 lm 121 lm/W
 /3 _ 3500 K **E** CRI >90 2001,2 lm 125,1 lm/W

Control
 0310 __ / _ A DALI-2, 1-10V, Push
 0310 __ / _ Z Casambi

Materials
 Diffuser: Pressed-glass. Horizontal rods: Steel.
 Body: Aluminum Canopy: Steel.

Light Source and electronics
 4 x LED 4,5 W 350 mA
 Constant Current 350 mA
 110-240V 50/60Hz

Packaging
 2 Boxes
 Total Vol 0,2100 m³
 Gross weight 11,8 Kg Net weight 4,8 Kg

Notes
 Pressed-glass diffuser.
Configuration layout at vibia.com
 Min. quantity, upcharge and extra lead time apply.



0311

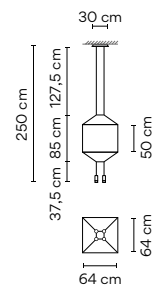

Finishes
 ● 04/ __ Black (RAL 9005)

LED temperature colour
 /1 _ 2700 K **D** CRI >90 1940 lm 121 lm/W
 /2 _ 3000 K **E** CRI >90 1940 lm 121 lm/W
 /3 _ 3500 K **E** CRI >90 2001,2 lm 125,1 lm/W

Control
 0311 __ / _ A DALI-2, 1-10V, Push
 0311 __ / _ Z Casambi

Materials
 Diffuser: Pressed-glass. Horizontal rods: Steel.
 Body: Aluminum Canopy: Steel.

Light Source and electronics
 4 x LED 4,5 W 350 mA
 Constant Current 350 mA
 110-240V 50/60Hz

Packaging
 2 Boxes
 Total Vol 0,1558 m³
 Gross weight 8,7 Kg Net weight 4,7 Kg

Notes
 Pressed-glass diffuser.
Configuration layout at vibia.com
 Min. quantity, upcharge and extra lead time apply.



0312

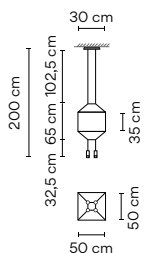

Finishes ● 04/ __ Black (RAL 9005)	LED temperature colour /1 _ 2700 K D → CRI >90 1940 lm 121 lm/W /2 _ 3000 K E → CRI >90 1940 lm 121 lm/W /3 _ 3500 K E → CRI >90 2001,2 lm 125,1 lm/W	Control 0312 __ / _ A DALI-2, 1-10V, Push <hr/> 0312 __ / _ Z Casambi
--	---	--

Materials Diffuser: Pressed-glass. Horizontal rods: Steel. Body: Aluminum Canopy: Steel.	Packaging 2 Boxes Total Vol 0,1558 m ³ Gross weight 8,6 Kg Net weight 4,6 Kg
Light Source and electronics 8 x LED 4,5 W 350 mA Constant Current 350 mA 110-240V 50/60Hz	Notes Pressed-glass diffuser. Configuration layout at vibia.com Min. quantity, upcharge and extra lead time apply



0313

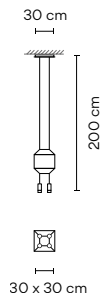

Finishes ● 04/ __ Black (RAL 9005)	LED temperature colour /1 _ 2700 K D → CRI >80 1961 lm 109 lm/W	Control 0313 __ / _ A DALI-2, 1-10V, Push <hr/> 0313 __ / _ Z Casambi
--	---	--

Materials Diffuser: Pressed-glass. Horizontal rods: Steel. Body: Aluminum Canopy: Steel.	Packaging 2 Boxes Total Vol 0,1238 m ³ Gross weight 7 Kg Net weight 4,5 Kg
Light Source and electronics 4 x LED 4,5 W 350 mA Constant Current 350 mA 110-240V 50/60Hz	Notes Pressed-glass diffuser. Configuration layout at vibia.com Min. quantity, upcharge and extra lead time apply.



0399

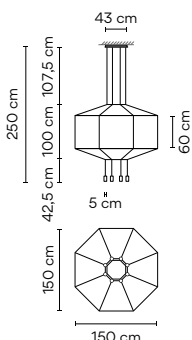



Finishes ● 04/ __ Black (RAL 9005)	LED temperature colour /1 _ 2700 K D → CRI >90 3880 lm 121 lm/W	Control 0399 __ / _ A DALI-2, 1-10V, Push <hr/> 0399 __ / _ Z Casambi
--	---	--

Materials Diffuser: Polycarbonate. Horizontal rods: Steel. Body: Aluminum Canopy: Steel.	Packaging 2 Boxes Total Vol 0,3245 m ³ Gross weight 20,6 Kg Net weight 9,6 Kg
Light Source and electronics 8 x LED 4,5 W 350 mA Constant Current 350 mA 110-240V 50/60Hz	Notes Without pressed-glass diffuser. Configuration layout at vibia.com Min. quantity, upcharge and extra lead time apply.

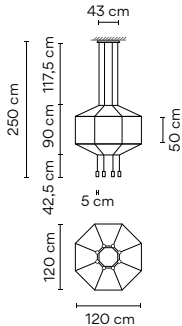

0400



Finishes ● 04/ _ _ Black (RAL 9005)
 LED temperature colour /1_ 2700 K  CRI >90 3880 lm 121 lm/W

Control 0400 _ _ / _ A DALI-2, 1-10V, Push
 0400 _ _ / _ Z Casambi

Materials Diffuser: Polycarbonate. Horizontal rods: Steel.
 Body: Aluminum Canopy: Steel.

Light Source and electronics 8 x LED 4,5 W 350 mA
 Constant Current 350 mA
 110-240V 50/60Hz

Packaging 2 Boxes
 Total Vol 0,3245 m³
 Gross weight 20,20 Kg Net weight 8,95 Kg

Notes Without pressed-glass diffuser.

Configuration layout at vibia.com
 Min. quantity, upcharge and extra lead time apply.

UNTIL STOCK RUNS OUT



0401

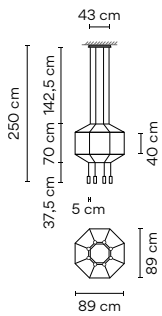

Finishes ● 04/ _ _ Black (RAL 9005)
 LED temperature colour /1_ 2700 K  CRI >90 3880 lm 121 lm/W

Control 0401 _ _ / _ A DALI-2, 1-10V, Push
 0401 _ _ / _ Z Casambi

Materials Diffuser: Polycarbonate. Horizontal rods: Steel.
 Body: Aluminum Canopy: Steel.

Light Source and electronics 8 x LED 4,5 W 350 mA
 Constant Current 350 mA
 110-240V 50/60Hz

Packaging 2 Boxes
 Total Vol 0,2100 m³
 Gross weight 17,75 Kg Net weight 8,75 Kg

Notes Without pressed-glass diffuser.

Configuration layout at vibia.com
 Min. quantity, upcharge and extra lead time apply.

UNTIL STOCK RUNS OUT



0402

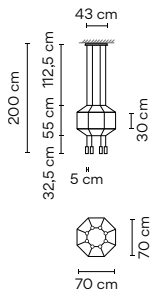

Finishes ● 04/ _ _ Black (RAL 9005)
 LED temperature colour /1_ 2700 K  CRI >90 3880 lm 121 lm/W

Control 0402 _ _ / _ A DALI-2, 1-10V, Push
 0402 _ _ / _ Z Casambi

Materials Diffuser: Polycarbonate. Horizontal rods: Steel.
 Body: Aluminum Canopy: Steel.

Light Source and electronics 8 x LED 4,5 W 350 mA
 Constant Current 350 mA
 110-240V 50/60Hz

Packaging 2 Boxes
 Total Vol 0,1558 m³
 Gross weight 16,95 Kg Net weight 8,6 Kg

Notes Without pressed-glass diffuser.

Configuration layout at vibia.com
 Min. quantity, upcharge and extra lead time apply.

UNTIL STOCK RUNS OUT



0403

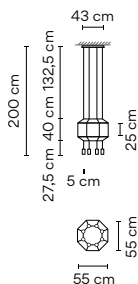

Finishes ● **04/** __ Black (RAL 9005) LED temperature colour /1_ 2700 K CRI >90 3880 lm 121 lm/W

Control **0403** __ / _ A DALI-2, 1-10V, Push

0403 __ / _ Z Casambi

Materials Diffuser: Polycarbonate. Horizontal rods: Steel. Body: Aluminum Canopy: Steel.

Light Source and electronics 8 x LED 4,5 W 350 mA Constant Current 350 mA 110-240V 50/60Hz

Packaging 2 Boxes Total Vol 0,1558 m³ Gross weight 16,65 Kg Net weight 8,5 Kg

Notes Without pressed-glass diffuser.

Configuration layout at vibia.com Min. quantity, upcharge and extra lead time apply.

UNTIL STOCK RUNS OUT



0404

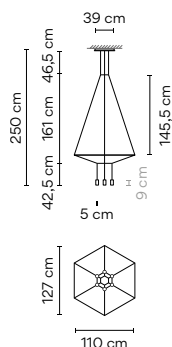

Finishes ● **04/** __ Black (RAL 9005) LED temperature colour /1_ 2700 K CRI >90 2910 lm 121 lm/W

Control **0404** __ / _ A DALI-2, 1-10V, Push

0404 __ / _ Z Casambi

Materials Diffuser: Polycarbonate. Horizontal rods: Steel. Body: Aluminum Canopy: Steel.

Light Source and electronics 6 x LED 4,5 W 350 mA Constant Current 350 mA 110-240V 50/60Hz

Packaging 2 Boxes Total Vol 0,3245 m³ Gross weight 15,55 Kg Net weight 5,65 Kg

Notes Without pressed-glass diffuser.

Configuration layout at vibia.com Min. quantity, upcharge and extra lead time apply.

UNTIL STOCK RUNS OUT



0405

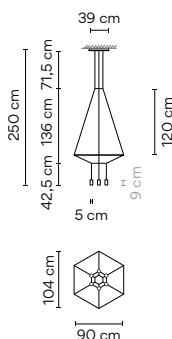

Finishes ● **04/** __ Black (RAL 9005) LED temperature colour /1_ 2700 K CRI >90 2910 lm 121 lm/W

Control **0405** __ / _ A DALI-2, 1-10V, Push

0405 __ / _ Z Casambi

Materials Diffuser: Polycarbonate. Horizontal rods: Steel. Body: Aluminum Canopy: Steel.

Light Source and electronics 6 x LED 4,5 W 350 mA Constant Current 350 mA 110-240V 50/60Hz

Packaging 2 Boxes Total Vol 0,3245 m³ Gross weight 15,55 Kg Net weight 5,65 Kg

Notes Without pressed-glass diffuser.

Configuration layout at vibia.com Min. quantity, upcharge and extra lead time apply.

UNTIL STOCK RUNS OUT



0406

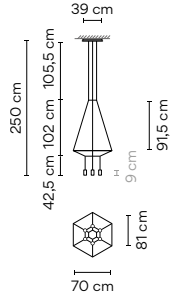

Finishes ● 04/ _ _ Black (RAL 9005)
 LED temperature colour /1_ 2700 K CRI >90 2910 lm 121 lm/W

Control 0406 _ _ / _ A DALI-2, 1-10V, Push
 0406 _ _ / _ Z Casambi

Materials Diffuser: Polycarbonate. Horizontal rods: Steel.
 Body: Aluminum Canopy: Steel.

Light Source and electronics 6 x LED 4,5 W 350 mA
 Constant Current 350 mA
 110-240V 50/60Hz

Packaging 2 Boxes
 Total Vol 0,2100 m³
 Gross weight 13,1 Kg Net weight 5,2 Kg

Notes Without pressed-glass diffuser.
 Configuration layout at vibia.com
 Min. quantity, upcharge and extra lead time apply.

UNTIL STOCK RUNS OUT



0407

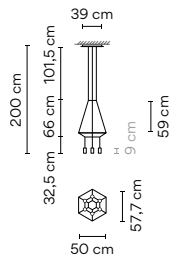

Finishes ● 04/ _ _ Black (RAL 9005)
 LED temperature colour /1_ 2700 K CRI >90 2910 lm 121 lm/W

Control 0407 _ _ / _ A DALI-2, 1-10V, Push
 0407 _ _ / _ Z Casambi

Materials Diffuser: Polycarbonate. Horizontal rods: Steel.
 Body: Aluminum Canopy: Steel.

Light Source and electronics 6 x LED 4,5 W 350 mA
 Constant Current 350 mA
 110-240V 50/60Hz

Packaging 2 Boxes
 Total Vol 0,1558 m³
 Gross weight 10 Kg Net weight 5,1 Kg

Notes Without pressed-glass diffuser.
 Configuration layout at vibia.com
 Min. quantity, upcharge and extra lead time apply.

UNTIL STOCK RUNS OUT



0408

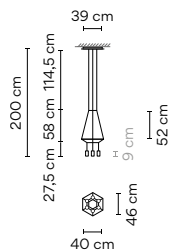

Finishes ● 04/ _ _ Black (RAL 9005)
 LED temperature colour /1_ 2700 K CRI >90 2910 lm 121 lm/W

Control 0408 _ _ / _ A DALI-2, 1-10V, Push
 0408 _ _ / _ Z Casambi

Materials Diffuser: Polycarbonate. Horizontal rods: Steel.
 Body: Aluminum Canopy: Steel.

Light Source and electronics 6 x LED 4,5 W 350 mA
 Constant Current 350 mA
 110-240V 50/60Hz

Packaging 2 Boxes
 Total Vol 0,1238 m³
 Gross weight 8,4 Kg Net weight 5 Kg

Notes Without pressed-glass diffuser.
 Configuration layout at vibia.com
 Min. quantity, upcharge and extra lead time apply.

UNTIL STOCK RUNS OUT



0409

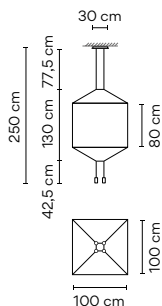

Finishes ● **04/** __ Black (RAL 9005) LED temperature colour /1_ 2700 K CRI >90 1940 lm 121 lm/W

Control **0409** __ / _ A DALI-2, 1-10V, Push

0409 __ / _ Z Casambi

Materials Diffuser: Polycarbonate. Horizontal rods: Steel. Body: Aluminum Canopy: Steel.

Light Source and electronics 4 x LED 4,5 W 350 mA Constant Current 350 mA 110~240V 50/60Hz

Packaging 2 Boxes Total Vol 0,2100 m³ Gross weight 12,3 Kg Net weight 5,3 Kg

Notes Without pressed-glass diffuser.

Configuration layout at vibia.com Min. quantity, upcharge and extra lead time apply.

UNTIL STOCK RUNS OUT



0410

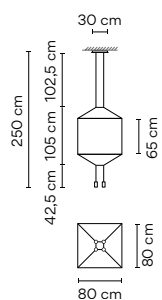

Finishes ● **04/** __ Black (RAL 9005) LED temperature colour /1_ 2700 K CRI >90 1940 lm 121 lm/W

Control **0410** __ / _ A DALI-2, 1-10V, Push

0410 __ / _ Z Casambi

Materials Diffuser: Polycarbonate. Horizontal rods: Steel. Body: Aluminum Canopy: Steel.

Light Source and electronics 4 x LED 4,5 W 350 mA Constant Current 350 mA 110~240V 50/60Hz

Packaging 2 Boxes Total Vol 0,2100 m³ Gross weight 11,8 Kg Net weight 4,8 Kg

Notes Without pressed-glass diffuser.

Configuration layout at vibia.com Min. quantity, upcharge and extra lead time apply.

UNTIL STOCK RUNS OUT



0411

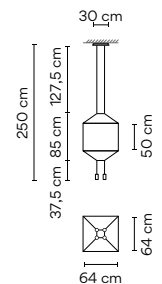

Finishes ● **04/** __ Black (RAL 9005) LED temperature colour /1_ 2700 K CRI >90 1940 lm 121 lm/W

Control **0411** __ / _ A DALI-2, 1-10V, Push

0411 __ / _ Z Casambi

Materials Diffuser: Polycarbonate. Horizontal rods: Steel. Body: Aluminum Canopy: Steel.

Light Source and electronics 4 x LED 4,5 W 350 mA Constant Current 350 mA 110~240V 50/60Hz

Packaging 2 Boxes Total Vol 0,1558 m³ Gross weight 11,4 Kg Net weight 4,7 Kg

Notes Without pressed-glass diffuser.

Configuration layout at vibia.com Min. quantity, upcharge and extra lead time apply.

UNTIL STOCK RUNS OUT



0412

Finishes ● 04/ _ _ Black (RAL 9005)
 LED temperature colour /1_ 2700 K  CRI >90 1940 lm 121 lm/W

Control 0412 _ _ / _ A DALI-2, 1-10V, Push
 0412 _ _ / _ Z Casambi

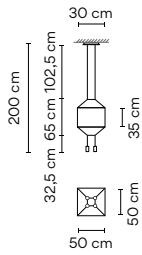

Materials
 Diffuser: Polycarbonate. Horizontal rods: Steel.
 Body: Aluminum Canopy: Steel.

Light Source and electronics
 4 x LED 4,5 W 350 mA
 Constant Current 350 mA
 110-240V 50/60Hz

Packaging
 2 Boxes
 Total Vol 0,1558 m³
 Gross weight 11,2 Kg Net weight 4,6 Kg

Notes
 Without pressed-glass diffuser.
Configuration layout at vibia.com
 Min. quantity, upcharge and extra lead time apply.

UNTIL STOCK RUNS OUT



0413

Finishes ● 04/ _ _ Black (RAL 9005)
 LED temperature colour /1_ 2700 K  CRI >90 1940 lm 121 lm/W

Control 0413 _ _ / _ A DALI-2, 1-10V, Push
 0413 _ _ / _ Z Casambi

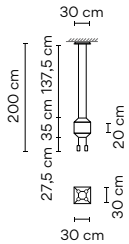

Materials
 Diffuser: Polycarbonate. Horizontal rods: Steel.
 Body: Aluminum Canopy: Steel.

Light Source and electronics
 4 x LED 4,5 W 350 mA
 Constant Current 350 mA
 110-240V 50/60Hz

Packaging
 2 Boxes
 Total Vol 0,1238 m³
 Gross weight 7 Kg Net weight 4,5 Kg

Notes
 Without pressed-glass diffuser.
Configuration layout at vibia.com
 Min. quantity, upcharge and extra lead time apply.

UNTIL STOCK RUNS OUT



Wireflow Lineal

Design by Arik Levy

Crafted of black, electrical cables and lacquered metal rods, Linear traces an airy, two-dimensional outline that lends it a powerful graphic presence. The slim cables are tipped with LED terminals and can be customised.

Pendants

0320

57 cm

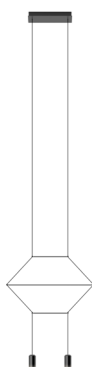

0325

155 cm

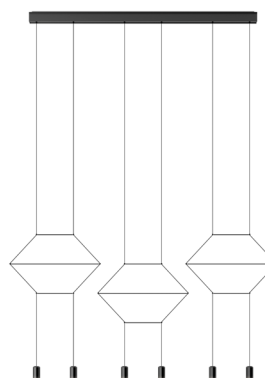

0330

275 cm

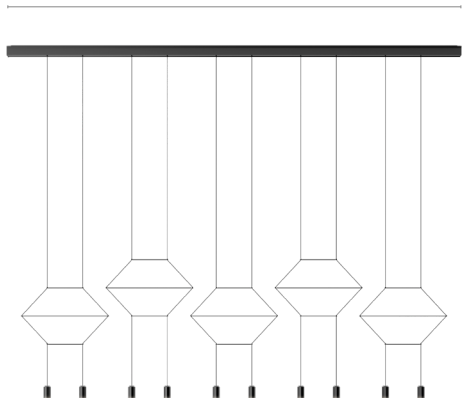

0332

275 cm

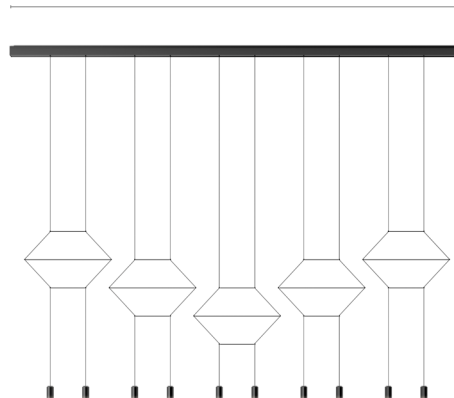

0338

145 cm

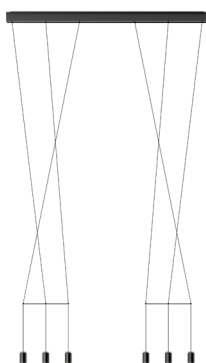

0340

205 cm

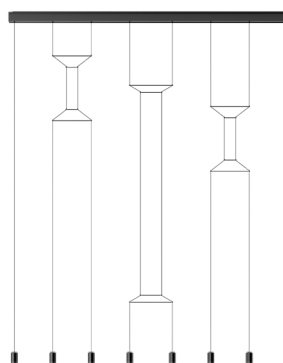

Each project is unique. Visit vibia.com and chose among multiple compositions designed and adapted to your project needs.

Personalise your own Wireflow composition quick and easy at vibia.com



Without pressed-glass diffuser.

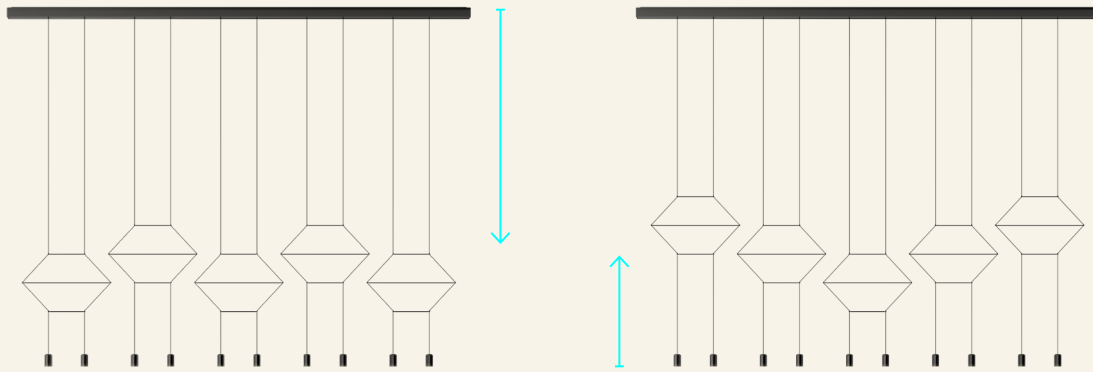

0320

Finishes
 ● 04/ __ Black (RAL 9005)

LED temperature colour
 /1_ 2700 K [D] CRI >90 970 lm 121 lm/W
 /2_ 3000 K [E] CRI >90 970 lm 121 lm/W
 /3_ 3500 K [E] CRI >90 1000,6 lm 125,1 lm/W

Control
 0320 __ / _ 1 DALI
 0320 __ / _ B 1-10V, Push
 0320 __ / _ Z Casambi

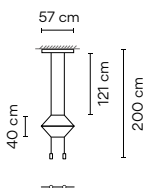

Materials
 Diffuser: Polycarbonate. Horizontal rods: Steel. Body: Aluminum. Canopy: Aluminum.

Light Source and electronics
 2 x LED 4,5 W 350 mA
 Constant Current 350 mA
 110-240V 50/60Hz

Packaging
 1 Box 0,20 x 0,075 x 0,70 m
 Vol 0,0150 m³
 Gross weight 5,1 Kg Net weight 2,6 Kg

Notes
 Linear canopy
 LED [Symbol] IP20 CE EAC [Symbol] Bi-volt

0325

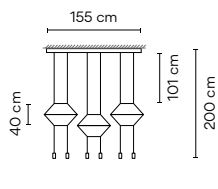

<p>Finishes</p> <ul style="list-style-type: none"> ● 04/ __ Black (RAL 9005) 	<p>LED temperature colour</p> <ul style="list-style-type: none"> /1_ 2700 K D CRI >90 2910 lm 121 lm/W /2_ 3000 K E CRI >90 2910 lm 121 lm/W /3_ 3500 K E CRI >90 3001,8 lm 125,1 lm/W 	<p>Control</p> <p>0325 __ / _ 1 DALI</p> <hr/> <p>0325 __ / _ B 1-10V, Push</p> <hr/> <p>0325 __ / _ Z Casambi</p>
<p>Materials</p> <p>Diffuser: Polycarbonate. Horizontal rods: Steel. Body: Aluminum. Canopy: Aluminum.</p>		
<p>Light Source and electronics</p> <p>6 x LED 4,5 W 350 mA Constant Current 350 mA 110~240V 50/60Hz</p>		
<p>Packaging</p> <p>1 Box 0,20 x 0,075 x 2,30 m Vol 0,0345 m³ Gross weight 8 Kg Net weight 4,5 Kg</p>		
<p>Notes</p> <p>Linear canopy</p>		
<p> </p>		

0330

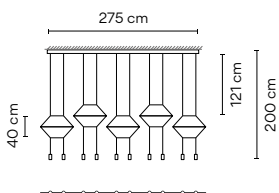

<p>Finishes</p> <ul style="list-style-type: none"> ● 04/ __ Black (RAL 9005) 	<p>LED temperature colour</p> <ul style="list-style-type: none"> /1_ 2700 K D CRI >90 4850 lm 121 lm/W /2_ 3000 K E CRI >90 4850 lm 121 lm/W /3_ 3500 K E CRI >90 5003,0 lm 125,1 lm/W 	<p>Control</p> <p>0330 __ / _ 1 DALI</p> <hr/> <p>0330 __ / _ B 1-10V, Push</p> <hr/> <p>0330 __ / _ Z Casambi</p>
<p>Materials</p> <p>Diffuser: Polycarbonate. Horizontal rods: Steel. Body: Aluminum. Canopy: Aluminum.</p>		
<p>Light Source and electronics</p> <p>10 x LED 4,5 W 700 mA Constant Current 350 mA 220~240V 50/60Hz</p>		
<p>Packaging</p> <p>1 Box 0,20 x 0,075 x 3,30 m Vol 0,0495 m³ Gross weight 9,5 Kg Net weight 5,0 Kg</p>		
<p>Notes</p> <p>Linear canopy</p>		
<p> </p>		

0332

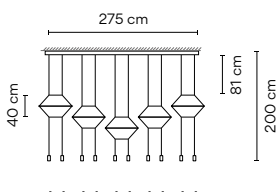

<p>Finishes</p> <ul style="list-style-type: none"> ● 04/ __ Black (RAL 9005) 	<p>LED temperature colour</p> <ul style="list-style-type: none"> /1_ 2700 K D CRI >80 4902,7 lm 109 lm/W 	<p>Control</p> <p>0332 __ / _ 1 DALI</p> <hr/> <p>0332 __ / _ B 1-10V, Push</p> <hr/> <p>0332 __ / _ Z Casambi</p>
<p>Materials</p> <p>Diffuser: Polycarbonate. Horizontal rods: Steel. Body: Aluminum. Canopy: Aluminum.</p>		
<p>Light Source and electronics</p> <p>10 x LED 4,5 W 700 mA Constant Current 350 mA 220~240V 50/60Hz</p>		
<p>Packaging</p> <p>1 Box 0,20 x 0,075 x 3,30 m Vol 0,0345 m³ Gross weight 9,2 Kg Net weight 8,3 Kg</p>		
<p>Notes</p> <p>Linear canopy.</p> <p>UNTIL STOCK RUNS OUT</p>		
<p> </p>		

0338

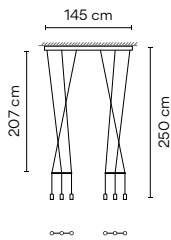

Finishes
 ● 04/ _ _ Black (RAL 9005)

LED temperature colour
 /1 _ 2700 K CRI >90 2910 lm 121 lm/W
 /3 3500 K CRI >90 3001,8 lm 125,1 lm/W

Control
 0338 _ _ / _ 1 DALI

0338 _ _ / _ B 1-10V, Push

0338 _ _ / _ Z Casambi

Materials

Diffuser: Polycarbonate. Horizontal rods: Steel. Body: Aluminum. Canopy: Aluminum.

Light Source and electronics

6 x LED 4,5 W 350 mA
 Constant Current 350 mA
 110-240V 50/60Hz

Packaging

1 Box 0,20 x 0,075 x 3,30 m
 Vol 0,0495 m³
 Gross weight 9,5 Kg Net weight 5,0 Kg

Notes

Linear canopy



0340

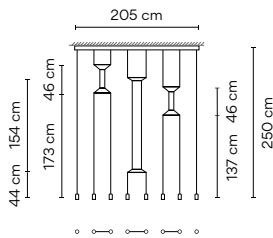

Finishes
 ● 04/ _ _ Black (RAL 9005)

LED temperature colour
 /1 _ 2700 K CRI >90 3922 lm 109 lm/W

Control
 0340 _ _ / _ 1 DALI

0340 _ _ / _ B 1-10V, Push

0340 _ _ / _ Z Casambi

Materials

Diffuser: Polycarbonate. Horizontal rods: Steel. Body: Aluminum. Canopy: Aluminum.

Light Source and electronics

8 x LED 4,5 W 700 mA
 Constant Current 350 mA
 220-240V 50/60Hz

Packaging

1 Box 0,20 x 0,075 x 2,30 m
 Vol 0,0345 m³
 Gross weight 10,2 Kg Net weight 9,3 Kg

Notes

Linear canopy.

UNTIL STOCK RUNS OUT

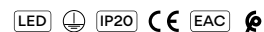

Wireflow FreeForm

Design by Arik Levy

Crafted of lean, electrical cables that trace airy, geometric outlines, Free Form is equal parts light and fluidity. The customisable fixture features endlessly adjustable shapes and heights, LED light points, and a wall or ceiling canopy to suit any space.

Pendants

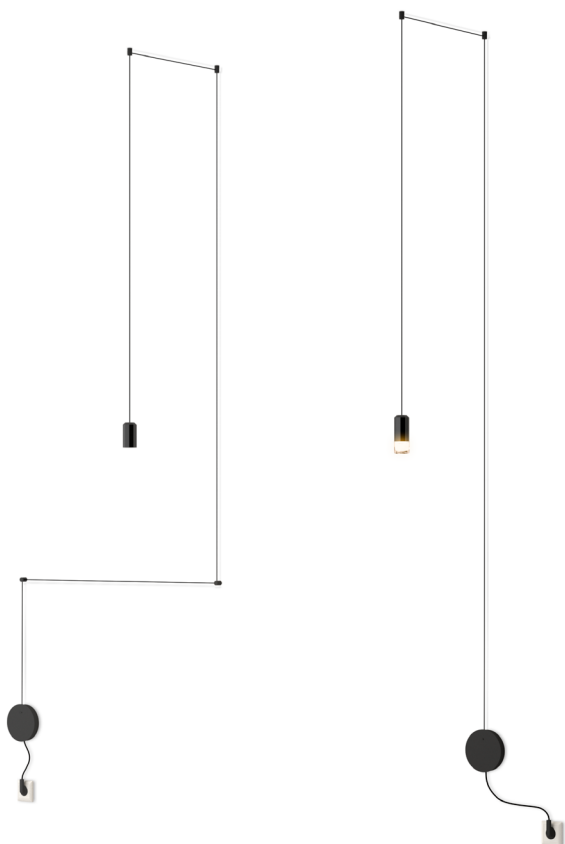

1160 | 10 / 1A | _18 |

Model | Finish | LED temperature colour | Control | Electrical connection | Only for pendants

Each project is unique. Visit vibia.com and chose among multiple compositions designed and adapted to your project needs.

Personalise your own Wireflow composition quick and easy at vibia.com



Pressed-glass diffuser.
*Without pressed-glass diffuser.

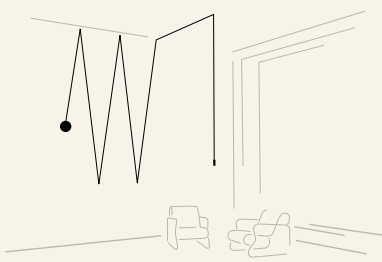
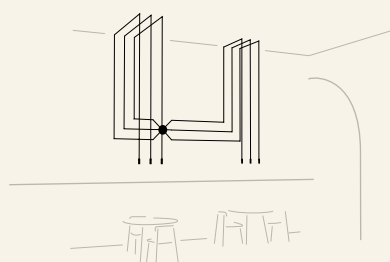

0345

Finishes
● 04/ __ Black (RAL 9005)

LED temperature colour
/1 _ 2700 K CRI >90 485 lm 121 lm/W
/2 _ 3000 K CRI >90 485 lm 121 lm/W
/3 _ 3500 K CRI >90 500,3 lm 125,1 lm/W

Control
0345 __ / _ 1 DALI-2
0345 __ / _ B 1-10V, Push
0345 __ / _ Z Casambi

Materials
Diffuser: Pressed-glass. Body: Aluminum.
Canopy: Steel.

Light Source and electronics
1 x LED 4,5 W 700 mA
Constant Current 350 mA
100-240V 50/60Hz

Packaging
1 Box 0,25 x 0,42 x 0,42 m
Vol 0,0441 m³
Gross weight 2,6 Kg Net weight 2,34 Kg

Notes
Pressed-glass diffuser.
Extra cable length.

Bi-volt

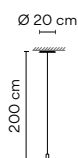

Electrical connection
Surface
_18 Free Wire
_23 Built-in
_31 Remote Micro for plaster ceilings
_32 Remote XXS for all types of drop ceilings

0347

Finishes ● **04/** __ Black (RAL 9005) LED temperature colour /1_ 2700 K  CRI >80 490 lm 109 lm/W Control **0347** __ / _ 5 Push

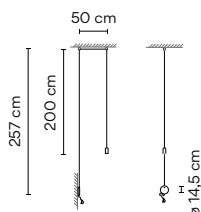

Materials

Diffuser: Polycarbonate. Body: Aluminum. Canopy: Steel.

Light Source and electronics

1 x LED 4,5 W 350 mA
Constant Current 350 mA
100~240V 50/60Hz

Packaging

1 Box 0,13 x 0,20 x 0,20 m
Vol 0,0055 m³
Gross weight 1,5 Kg Net weight 1,35 Kg

Notes

Electric cable 2,5 m. With plug.
Dimmer push button on the wall plate.
Without pressed-glass diffuser.



0348

Finishes ● **04/** __ Black (RAL 9005) LED temperature colour /1_ 2700 K  CRI >80 490 lm 109 lm/W Control **0348** __ / _ 5 Push

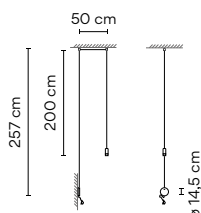

Materials

Diffuser: Pressed-glass. Body: Aluminum. Canopy: Steel.

Light Source and electronics

1 x LED 4,5 W 350 mA
Constant Current 350 mA
100~240V 50/60Hz

Packaging



1 Box 0,26 x 0,26 x 0,26 m
Vol 0,0175 m³
Gross weight 1,9 Kg Net weight 1,71 Kg

Notes

Electric cable 2,5 m. With plug.
Dimmer push button on the wall plate.
Without pressed-glass diffuser.



0349

Finishes ● **04/** __ Black (RAL 9005) LED temperature colour /1_ 2700 K  CRI >90 970 lm 121 lm/W /2_ 3000 K  CRI >90 970 lm 121 lm/W /3_ 3500 K  CRI >90 1000,6 lm 125,1 lm/W Control **0349** __ / _ A DALI-2, 1-10V, Push **0349** __ / _ Z Casambi

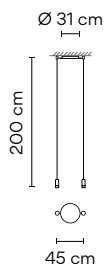

Materials

Diffuser: Pressed-glass. Body: Aluminum. Canopy: Steel.

Light Source and electronics

2 x LED 4,5 W 350 mA
Constant Current 350 mA
100~240V 50/60Hz

Packaging

1 Box 0,27 x 0,60 x 0,60 m
Vol 0,0972 m³
Gross weight 4,6 Kg Net weight 4,14 Kg

Notes

Pressed-glass diffuser.

UNTIL STOCK RUNS OUT



0350

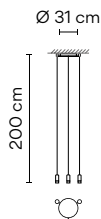

Finishes
 ● 04/ _ _ Black (RAL 9005)

LED temperature colour
 /1 _ 2700 K **D** CRI >90 1455 lm 121 lm/W
 /2 _ 3000 K **E** CRI >90 1455 lm 121 lm/W
 /3 _ 3500 K **E** CRI >90 1500,9 lm 125,1 lm/W

Control
 0350 _ _ / _ A DALI-2, 1-10V, Push
 0350 _ _ / _ Z Casambi

Materials
 Diffuser: Pressed-glass. Body: Aluminum. Canopy: Steel.

Light Source and electronics
 3 x LED 4,5 W 350 mA
 Constant Current 350 mA
 100~240V 50/60Hz

Packaging
 1 Box 0,27 x 0,60 x 0,60 m
 Vol 0,0972 m³
 Gross weight 5,2 Kg Net weight 4,68 Kg

Notes
 Pressed-glass diffuser.
UNTIL STOCK RUNS OUT



0351

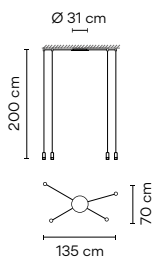

Finishes
 ● 04/ _ _ Black (RAL 9005)

LED temperature colour
 /1 _ 2700 K **D** CRI >90 1940 lm 121 lm/W
 /2 _ 3000 K **E** CRI >90 1940 lm 121 lm/W
 /3 _ 3500 K **E** CRI >90 2001,2 lm 125,1 lm/W

Control
 0351 _ _ / _ A DALI, 1-10V, Push
 0351 _ _ / _ Z Casambi

Materials
 Diffuser: Pressed-glass. Body: Aluminum. Canopy: Steel.

Light Source and electronics
 4 x LED 4,5 W 350 mA
 Constant Current 350 mA
 100~240V 50/60Hz

Packaging
 1 Box 0,27 x 0,60 x 0,60 m
 Vol 0,0972 m³
 Gross weight 5,6 Kg Net weight 5,04 Kg

Notes
 Pressed-glass diffuser.
UNTIL STOCK RUNS OUT



0353

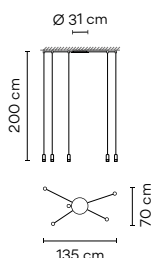

Finishes
 ● 04/ _ _ Black (RAL 9005)

LED temperature colour
 /1 _ 2700 K **D** CRI >90 2425 lm 121 lm/W
 /2 _ 3000 K **E** CRI >90 2425 lm 121 lm/W
 /3 _ 3500 K **E** CRI >90 2501,5 lm 125,1 lm/W

Control
 0353 _ _ / _ A DALI, 1-10V, Push
 0353 _ _ / _ Z Casambi

Materials
 Diffuser: Pressed-glass. Body: Aluminum. Canopy: Steel.

Light Source and electronics
 5 x LED 4,5 W 350 mA
 Constant Current 350 mA
 100~240V 50/60Hz

Packaging
 1 Box 0,27 x 0,60 x 0,60 m
 Vol 0,0972 m³
 Gross weight 6,1 Kg Net weight 5,49 Kg

Notes
 Pressed-glass diffuser.
UNTIL STOCK RUNS OUT



0355

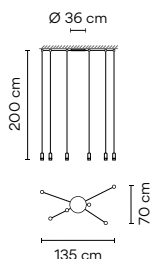

Finishes ● 04/ __ Black (RAL 9005)	LED temperature colour /1_ 2700 K D → CRI >90 2910 lm 121 lm/W	Control 0355 __ / __ A DALI, 1-10V, Push <hr/> 0355 __ / __ Z Casambi
	/2_ 3000 K E → CRI >90 2910 lm 121 lm/W	
	/3_ 3500 K E → CRI >90 3001,8 lm 125,1 lm/W	

Materials Diffuser: Pressed-glass. Body: Aluminum. Canopy: Steel.	Packaging 1 Box 0,27 x 0,60 x 0,60 m Vol 0,0972 m ³ Gross weight 6,7 Kg Net weight 6,03 Kg
Light Source and electronics 6 x LED 4,5 W 350 mA Constant Current 350 mA 100~240V 50/60Hz	Notes Pressed-glass diffuser. UNTIL STOCK RUNS OUT



0356

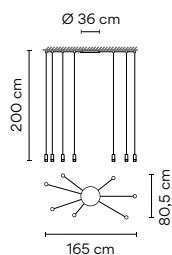

Finishes ● 04/ __ Black (RAL 9005)	LED temperature colour /1_ 2700 K D → CRI >90 3395 lm 121 lm/W	Control 0356 __ / __ A DALI, 1-10V, Push <hr/> 0356 __ / __ Z Casambi
	/2_ 3000 K E → CRI >90 3395 lm 121 lm/W	
	/3_ 3500 K E → CRI >90 3502,1 lm 125,1 lm/W	

Materials Diffuser: Pressed-glass. Body: Aluminum. Canopy: Steel.	Packaging 1 Box 0,27 x 0,60 x 0,60 m Vol 0,0972 m ³ Gross weight 7,9 Kg Net weight 7,11 Kg
Light Source and electronics 7 x LED 4,5 W 350 mA Constant Current 350 mA 100~240V 50/60Hz	Notes Pressed-glass diffuser. UNTIL STOCK RUNS OUT



0358

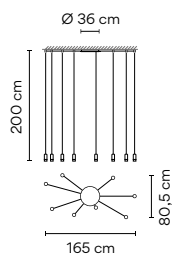

Finishes ● 04/ __ Black (RAL 9005)	LED temperature colour /1_ 2700 K D → CRI >90 3880 lm 121 lm/W	Control 0358 __ / __ A DALI, 1-10V, Push <hr/> 0358 __ / __ Z Casambi
	/2_ 3000 K E → CRI >90 3880 lm 121 lm/W	
	/3_ 3500 K E → CRI >90 4002,4 lm 125,1 lm/W	

Materials Diffuser: Pressed-glass. Body: Aluminum. Canopy: Steel.	Packaging 1 Box 0,27 x 0,60 x 0,60 m Vol 0,0972 m ³ Gross weight 8,4 Kg Net weight 7,56 Kg
Light Source and electronics 8 x LED 4,5 W 350 mA Constant Current 350 mA 100~240V 50/60Hz	Notes Pressed-glass diffuser. UNTIL STOCK RUNS OUT



0360

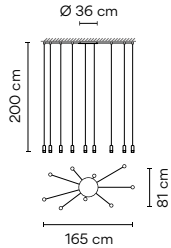

Finishes ● 04/ _ _ Black (RAL 9005)	LED temperature colour /1 _ 2700 K D >90 4365 lm 121 lm/W	Control 0360 _ _ / _ A DALI, 1-10V, Push 0360 _ _ / _ Z Casambi
	/2 _ 3000 K E >90 4365 lm 121 lm/W	
	/3 _ 3500 K E >90 4502,7 lm 125,1 lm/W	

Materials
 Diffuser: Pressed-glass. Body: Aluminum. Canopy: Steel.

Light Source and electronics
 9 x LED 4,5 W 350 mA
 Constant Current 350 mA
 100~240V 50/60Hz

Packaging
 1 Box 0,27 x 0,60 x 0,60 m
 Vol 0,0972 m³
 Gross weight 9,1 Kg Net weight 8,19 Kg

Notes
 Pressed-glass diffuser.
UNTIL STOCK RUNS OUT



0361

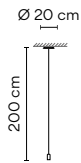

Finishes ● 04/ _ _ Black (RAL 9005)	LED temperature colour /1 _ 2700 K D >90 485 lm 121 lm/W	Control 0361 _ _ / _ 1 DALI 0361 _ _ / _ B 1-10V, Push 0361 _ _ / _ Z Casambi
	/2 _ 3000 K E >90 485 lm 121 lm/W	
	/3 _ 3500 K E >90 500,3 lm 125,10 lm/W	

Materials
 Diffuser: Polycarbonate. Body: Aluminum. Canopy: Steel.

Light Source and electronics
 1 x LED 4,5 W 700 mA
 Constant Current 350 mA
 100~240V 50/60Hz

Packaging
 1 Box 0,25 x 0,42 x 0,42 m
 Vol 0,0441 m³
 Gross weight 2,6 Kg Net weight 2,34 Kg

Notes
 Without pressed-glass diffuser.
 Additional cable length personalisation



0362

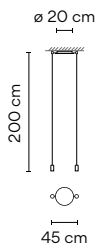

Finishes ● 04/ _ _ Black (RAL 9005)	LED temperature colour /1 _ 2700 K D >80 980 lm 109 lm/W	Control 0362 _ _ / _ A DALI-2, 1-10V, Push 0362 _ _ / _ Z Casambi
---	---	--

Materials
 Diffuser: Polycarbonate. Body: Aluminum. Canopy: Steel.

Light Source and electronics
 2 x LED 4,5 W 350 mA
 Constant Current 350 mA
 100~240V 50/60Hz

Packaging
 1 Box 0,27 x 0,60 x 0,60 m
 Vol 0,0972 m³
 Gross weight 4,6 Kg Net weight 4,14 Kg

Notes
 Without pressed-glass diffuser.
UNTIL STOCK RUNS OUT



Electrical connection

- _18 Surface Free Wire
- _23 Built-in
- _31 Remote Micro for plaster ceilings
- _32 Remote XXS for all types of drop ceilings

0363

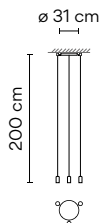

Finishes
 ● 04/ __ Black (RAL 9005)

LED temperature colour
 /1_ 2700 K CRI >80 1471 lm 109 lm/W

Control
 0363 __ / _ A
 DALI-2, 1-10V, Push

0363 __ / _ Z
 Casambi

Materials
 Diffuser: Polycarbonate. Body: Aluminum.
 Canopy: Steel.

Light Source and electronics
 3 x LED 4,5 W 350 mA
 Constant Current 350 mA
 100~240V 50/60Hz

Packaging
 1 Box 0,27 x 0,60 x 0,60 m
 Vol 0,0972 m³
 Gross weight 5,2 Kg Net weight 4,68 Kg

Notes
 Without pressed-glass diffuser.

UNTIL STOCK RUNS OUT



0364

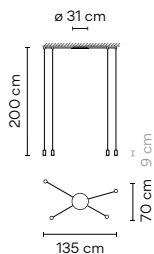

Finishes
 ● 04/ __ Black (RAL 9005)

LED temperature colour
 /1_ 2700 K CRI >80 1471 lm 109 lm/W

Control
 0364 __ / _ A
 DALI-2, 1-10V, Push

0364 __ / _ Z
 Casambi

Materials
 Diffuser: Polycarbonate. Body: Aluminum.
 Canopy: Steel.

Light Source and electronics
 4 x LED 4,5 W 350 mA
 Constant Current 350 mA
 100~240V 50/60Hz

Packaging
 1 Box 0,27 x 0,60 x 0,60 m
 Vol 0,0972 m³
 Gross weight 5,6 Kg Net weight 5,04 Kg

Notes
 Without pressed-glass diffuser.

UNTIL STOCK RUNS OUT



0365

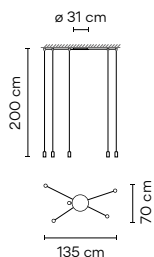

Finishes
 ● 04/ __ Black (RAL 9005)

LED temperature colour
 /1_ 2700 K CRI >80 2451 lm 109 lm/W

Control
 0365 __ / _ A
 DALI-2, 1-10V, Push

0365 __ / _ Z
 Casambi

Materials
 Diffuser: Polycarbonate. Body: Aluminum.
 Canopy: Steel.

Light Source and electronics
 5 x LED 4,5 W 350 mA
 Constant Current 350 mA
 100~240V 50/60Hz

Packaging
 1 Box 0,27 x 0,60 x 0,60 m
 Vol 0,0972 m³
 Gross weight 5,04 Kg Net weight 5,49 Kg

Notes
 Without pressed-glass diffuser.

UNTIL STOCK RUNS OUT



0366

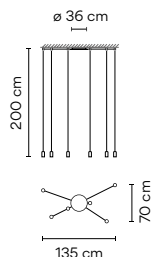

Finishes
 ● 04/ __ Black (RAL 9005)

LED temperature colour
 /1_ 2700 K CRI >80 2942 lm 109 lm/W

Control
 0366 __ / _ A
 DALI-2, 1-10V, Push

0366 __ / _ Z
 Casambi

Materials
 Diffuser: Polycarbonate. Body: Aluminum.
 Canopy: Steel.

Light Source and electronics
 6 x LED 4,5 W 350 mA
 Constant Current 350 mA
 100~240V 50/60Hz

Packaging
 1 Box 0,27 x 0,60 x 0,60 m
 Vol 0,0972 m³
 Gross weight 6,7 Kg Net weight 6,03 Kg

Notes
 Without pressed-glass diffuser.

UNTIL STOCK RUNS OUT



0367

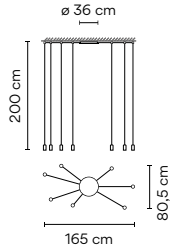

Finishes
 ● 04/ _ _ Black
 (RAL 9005)

LED temperature colour
 /1_ 2700 K
 CRI >80 3432 lm 109 lm/W

Control
 0367 _ _ / _ A
 DALI-2, 1-10V, Push
 0367 _ _ / _ Z
 Casambi

Materials

Diffuser: Polycarbonate. Body: Aluminum.
 Canopy: Steel.

Light Source and electronics

7 x LED 4,5 W 350 mA
 Constant Current 350 mA
 100~240V 50/60Hz

Packaging

1 Box 0,27 x 0,60 x 0,60 m
 Vol 0,0972 m³
 Gross weight 7,9 Kg Net weight 7,11 Kg

Notes

Without pressed-glass diffuser.

UNTIL STOCK RUNS OUT



0368

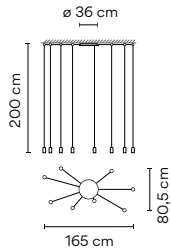

Finishes
 ● 04/ _ _ Black
 (RAL 9005)

LED temperature colour
 /1_ 2700 K
 CRI >80 3922 lm 109 lm/W

Control
 0368 _ _ / _ A
 DALI-2, 1-10V, Push
 0368 _ _ / _ Z
 Casambi

Materials

Diffuser: Polycarbonate. Body: Aluminum.
 Canopy: Steel.

Light Source and electronics

8 x LED 4,5 W 350 mA
 Constant Current 350 mA
 100~240V 50/60Hz

Packaging

1 Box 0,27 x 0,60 x 0,60 m
 Vol 0,0972 m³
 Gross weight 8,4 Kg Net weight 7,56 Kg

Notes

Without pressed-glass diffuser.

UNTIL STOCK RUNS OUT



0369

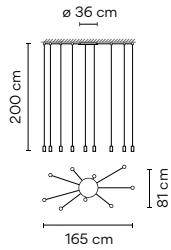

Finishes
 ● 04/ _ _ Black
 (RAL 9005)

LED temperature colour
 /1_ 2700 K
 CRI >80 4412 lm 109 lm/W

Control
 0369 _ _ / _ A
 DALI-2, 1-10V, Push
 0369 _ _ / _ Z
 Casambi

Materials

Diffuser: Polycarbonate. Body: Aluminum.
 Canopy: Steel.

Light Source and electronics

9 x LED 4,5 W 350 mA
 Constant Current 350 mA
 100~240V 50/60Hz

Packaging

1 Box 0,27 x 0,60 x 0,60 m
 Vol 0,0972 m³
 Gross weight 9,1 Kg Net weight 8,19 Kg

Notes

Without pressed-glass diffuser.

UNTIL STOCK RUNS OUT



Composing pendants

Next sketches are composed by one or more compositions

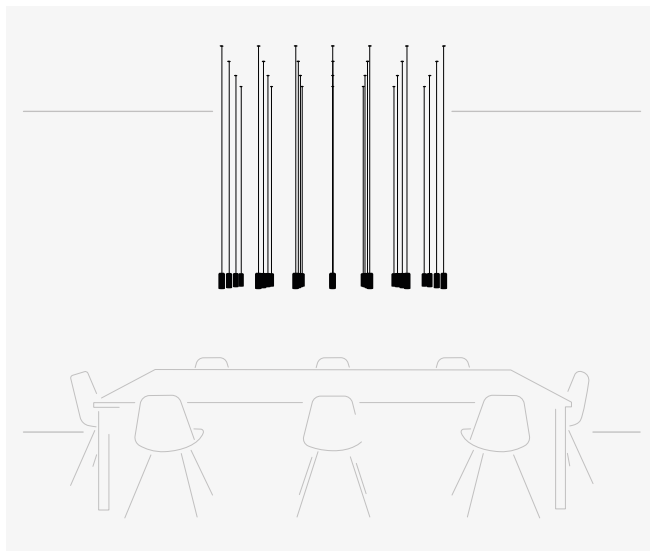

28 x 0361.



28 x 0345.

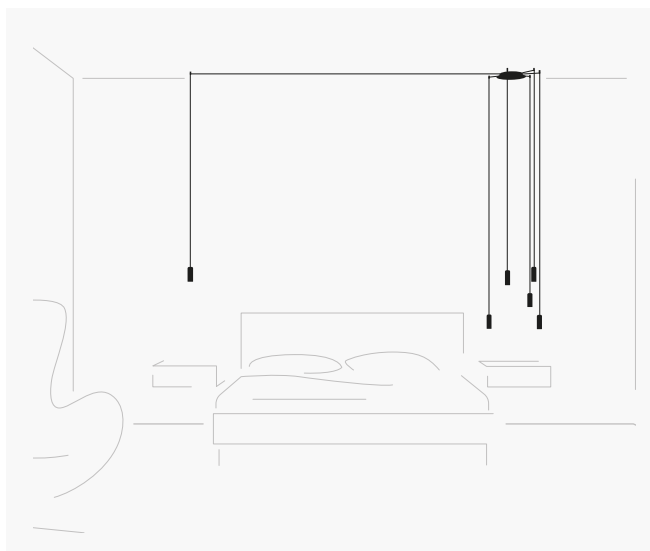

6 x 0345.

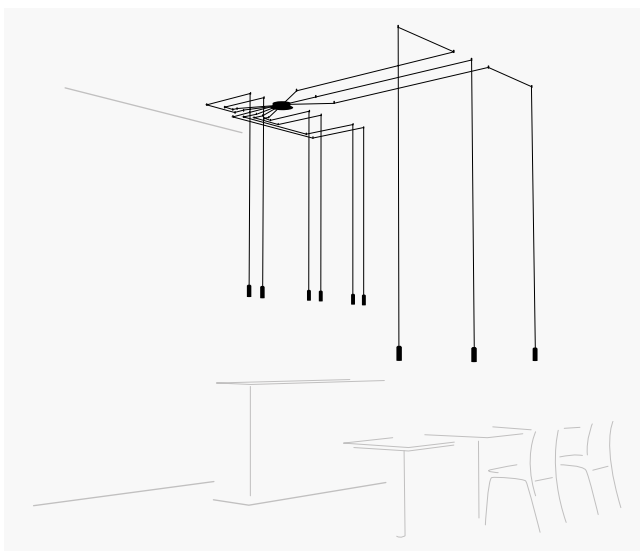

9 x 0361.

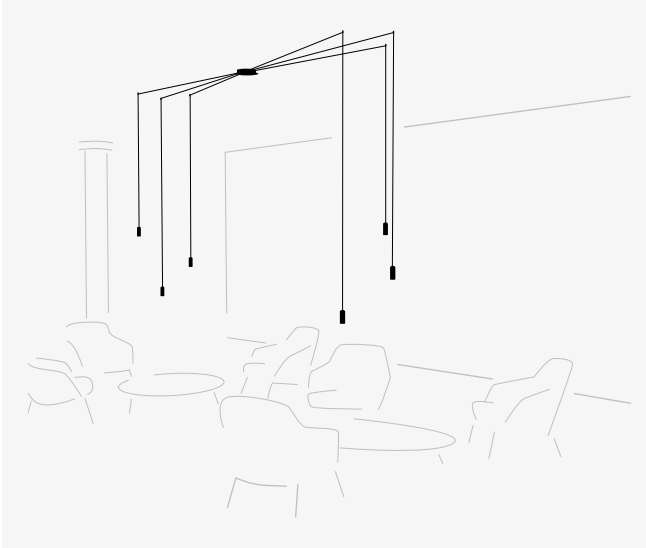

6 x 0361.

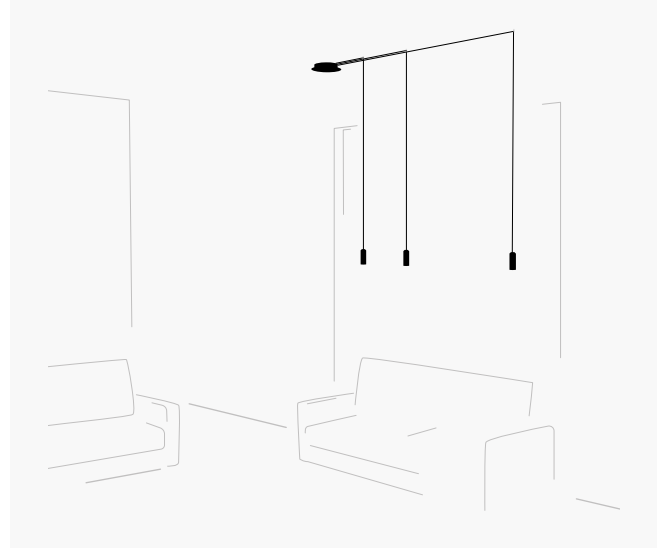

3 x 0361.

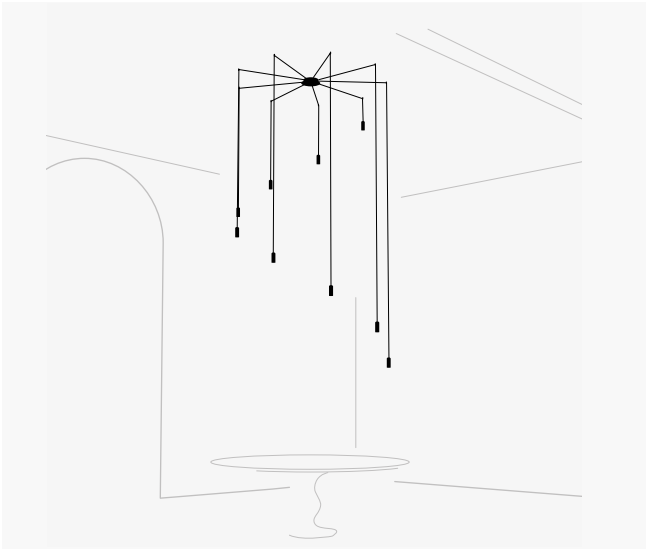

9 x 0345.

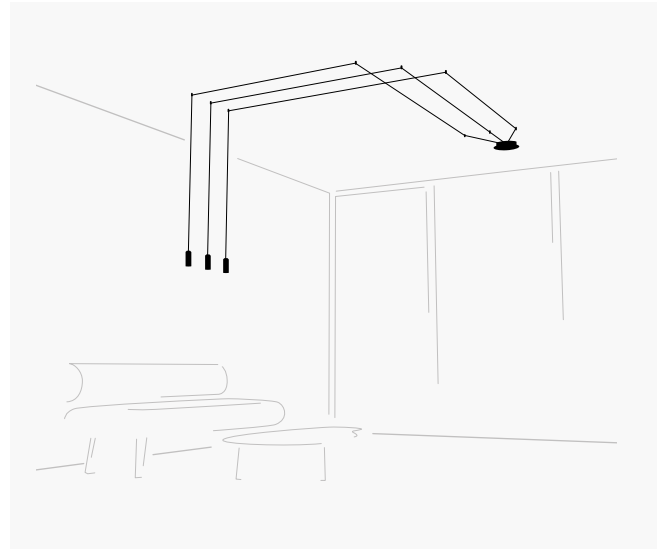

3 x 0361.

Composing pendants

Next sketches are composed by one or more compositions

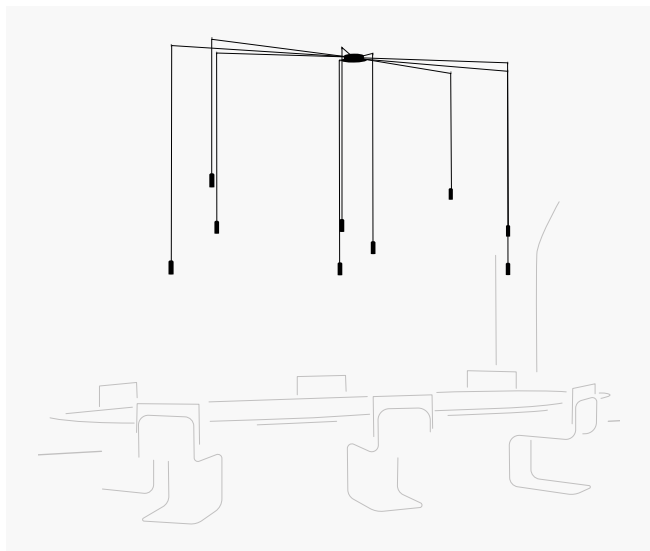

9 x 0361.

Each project is unique.
Visit vibia.com and
chose among multiple
compositions designed
and adapted to your
project needs.

Personalise your own
Wireflow FreeForm
composition quick
and easy at vibia.com

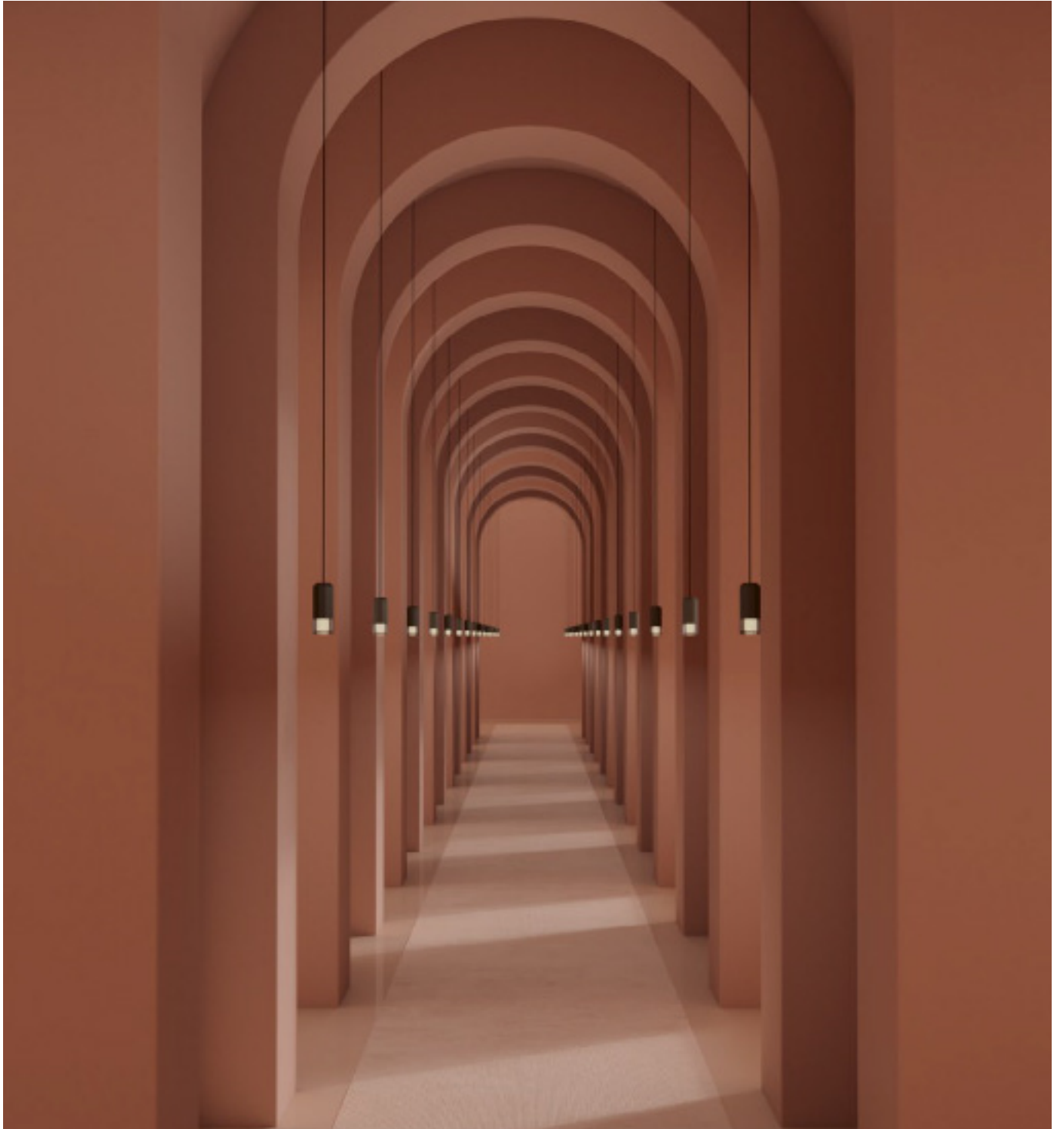

Electrical connection options for models 0345 / 0361

Choose your preferred installation option according to your needs. For each composition, the optimal minimum number of drivers will be delivered.

Drop ceiling

The innovative remote and built-in fittings accentuate the silkiness and lightness of compositions on suspended ceilings, its great visual grandeur taking center stage.

For Ref. 0345 / 0361

Remote

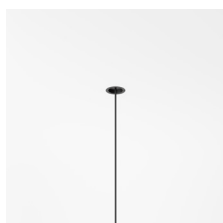

Micro ø 3 cm
height 7 cm
for plaster ceilings.
Black finish.

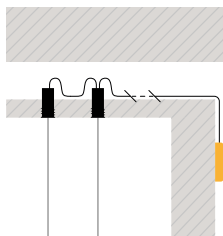

Built-in



ø 8 cm
height 6 cm
match with
fixture finish.

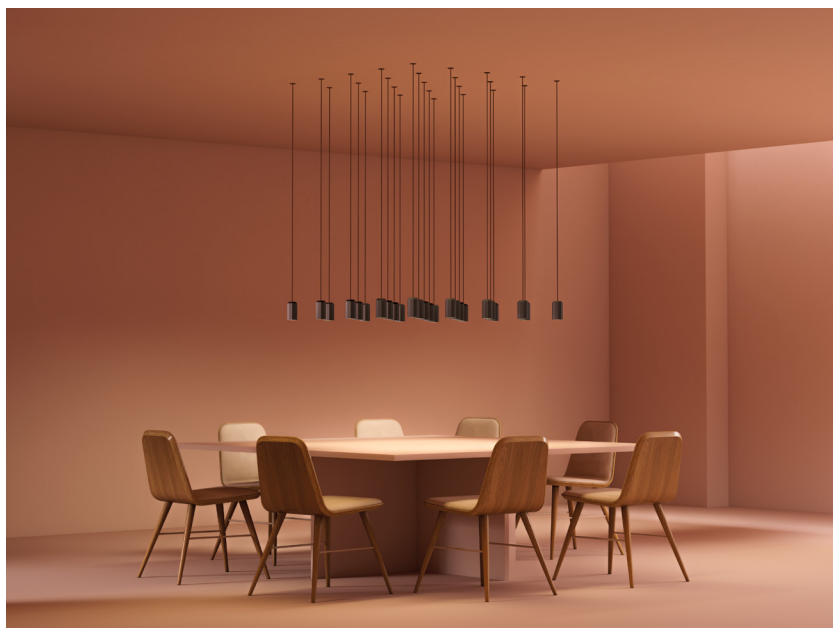
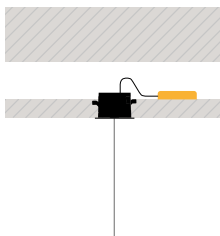

Regular ceiling

When architecture does not allow for performance, surface and free wire showcase possibilities for any need or desire with no limits, ideal for both individual or cluster arrangements.

For Ref. 0345 / 0361

Surface



ø 20 cm
match with
fixture finish.

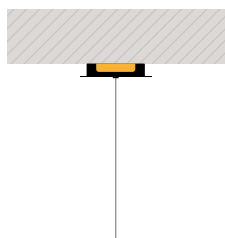

Free Wire

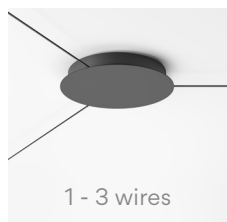

1 - 3 wires

ø 20 cm

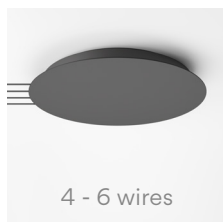

4 - 6 wires

ø 36 cm

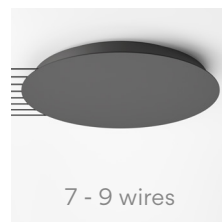

7 - 9 wires

ø 40 cm

you can choose the finish of the canopy
among black, white or any colour
matching one of the pendants.

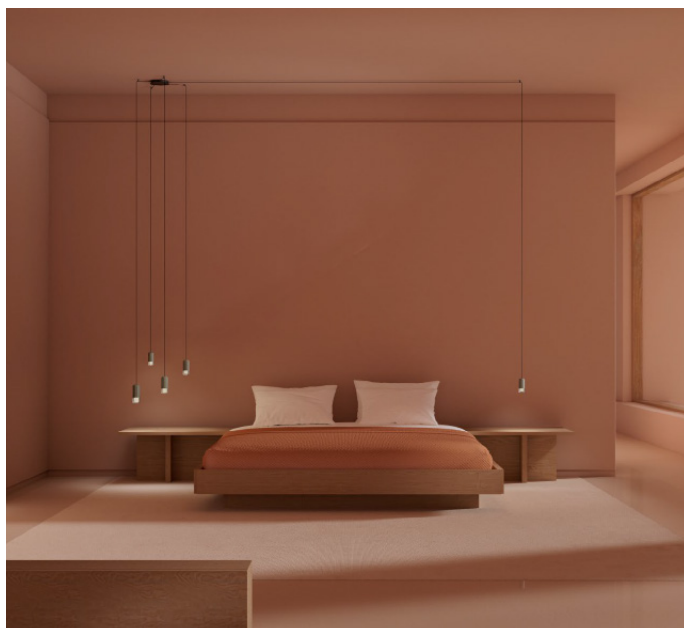
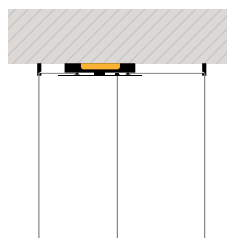

Wireflow Chandelier

Design by Arik Levy

Wireflow is a collection of pendant lights that are at once presence and absence. Featuring slender black, electrical cables tipped with LED light terminals, its three-dimensional forms represent a contemporary reinterpretation of the traditional chandelier.

Pendants

0315

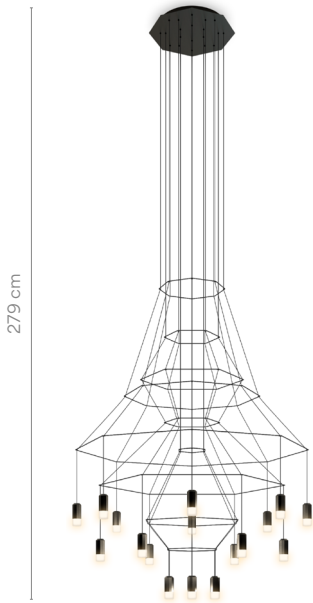

0374

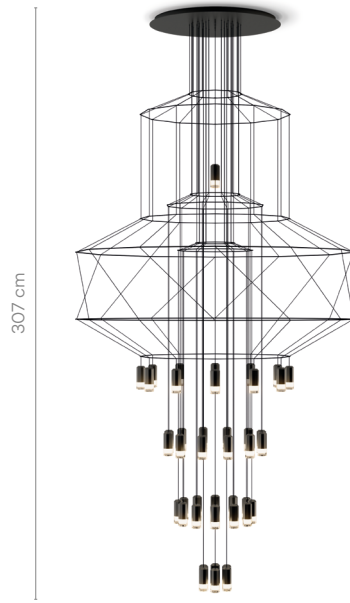

0375



0376

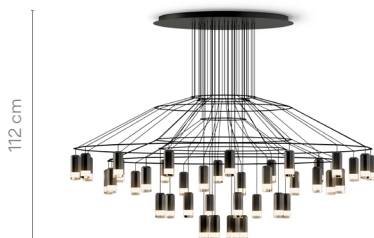

0377

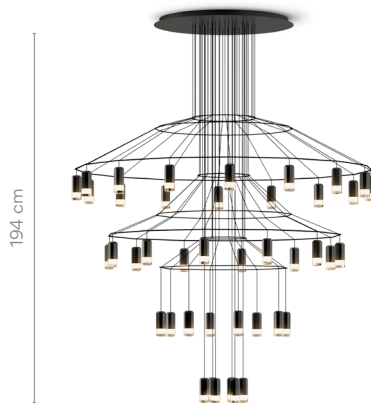

0378

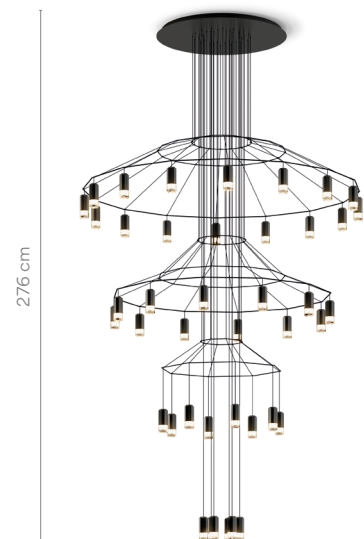

Each project is unique. Visit vibia.com and chose among multiple compositions designed and adapted to your project needs.

Personalise your own Wireflow composition quick and easy at vibia.com

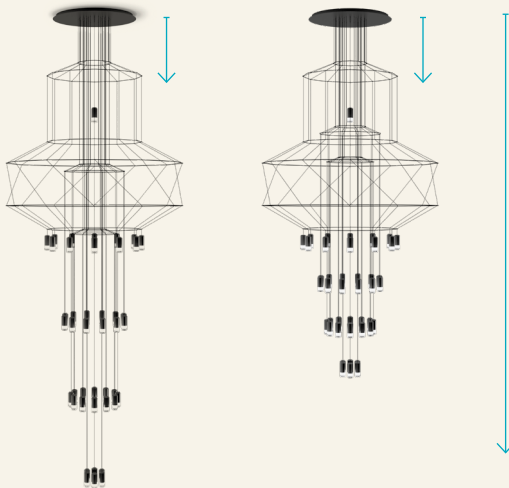
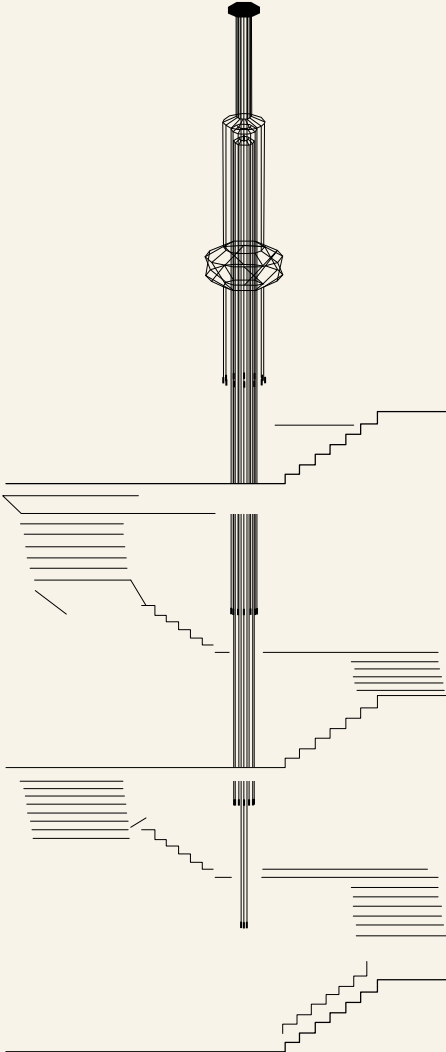

For configurations longer than 9 m, please ask Vibia customer service.



Wireflow Chandelier

0315

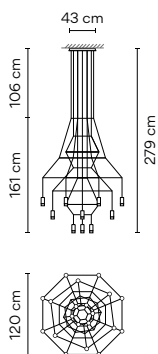

Finishes ● 04/ __ Black (RAL 9005)	LED temperature colour /1 _ 2700 K CRI >90 9700 lm 121 lm/W	Control 0315 __ / _ A DALI-2, 1-10V, Push <hr/> 0315 __ / _ Z Casambi
	/2 _ 3000 K CRI >90 9700 lm 121 lm/W	
	/3 _ 3500 K CRI >90 10006,1 lm 125,1 lm/W	

Materials Diffuser: Pressed-glass. Body: Aluminum. Canopy and horizontal rods: Steel.	Packaging 2 Boxes Total Vol 0,3832 m³ Gross weight 32 Kg Net weight 18 Kg
Light Source and electronics 20 x LED 4,5 W 700 mA Constant Current 700 mA 100~240V 50/60Hz	Notes Configuration layout at vibia.com



0374

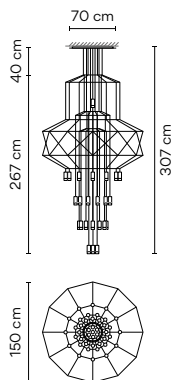

Finishes ● 04/ __ Black (RAL 9005)	LED temperature colour /1 _ 2700 K CRI >90 20855 lm 121 lm/W	Control 0374 __ / _ A DALI-2, 1-10V, Push <hr/> 0374 __ / _ Z Casambi
	/2 _ 3000 K CRI >90 20855 lm 121 lm/W	
	/3 _ 3500 K CRI >90 21513,1 lm 125,1 lm/W	

Materials Diffuser: Pressed-glass. Body: Aluminum. Canopy and horizontal rods: Steel.	Packaging 2 Boxes Total Vol 0,5000 m³ Gross weight 57 Kg Net weight 47 Kg
Light Source and electronics 43 x LED 4,5 W 700 mA Constant Current 700 mA 100~240V 50/60Hz	Notes Configuration layout at vibia.com



0375

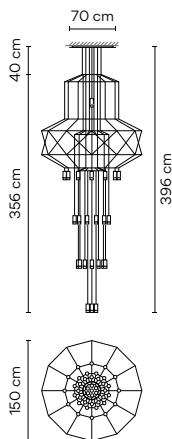

Finishes ● 04/ __ Black (RAL 9005)	LED temperature colour /1 _ 2700 K CRI >90 20855 lm 121 lm/W	Control 0375 __ / _ A DALI-2, 1-10V, Push <hr/> 0375 __ / _ Z Casambi
	/2 _ 3000 K CRI >90 20855 lm 121 lm/W	
	/3 _ 3500 K CRI >90 21513,1 lm 125,1 lm/W	

Materials Diffuser: Pressed-glass. Body: Aluminum. Canopy and horizontal rods: Steel.	Packaging 2 Boxes Total Vol 0,5000 m³ Gross weight 57 Kg Net weight 47 Kg
Light Source and electronics 43 x LED 4,5 W 700 mA Constant Current 700 mA 100~240V 50/60Hz	Notes Configuration layout at vibia.com



0376

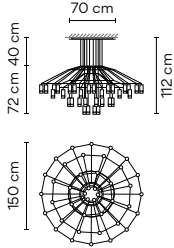

Finishes
 ● 04/ _ _ Black
 (RAL 9005)

LED temperature colour
 /1 _ 2700 K
 CRI >90 20370 lm 121 lm/W
 /2 _ 3000 K
 CRI >90 20370 lm 121 lm/W
 /3 _ 3500 K
 CRI >90 21012,8 lm 125,1 lm/W

Control
 0376 _ _ / _ A
 DALI-2, 1-10V, Push
 0376 _ _ / _ Z
 Casambi

Materials
 Diffuser: Pressed-glass. Body: Aluminum.
 Canopy and horizontal rods: Steel.

Light Source and electronics
 42 x LED 4,5 W 700 mA
 Constant Current 700 mA
 100~240V 50/60Hz

Packaging
 2 Boxes
 Total Vol 0,5000 m³
 Gross weight 56 Kg Net weight 46 Kg

Notes
 Configuration layout at vibia.com



0377

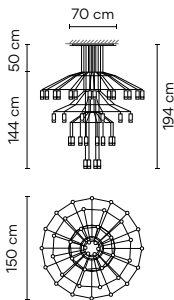

Finishes
 ● 04/ _ _ Black
 (RAL 9005)

LED temperature colour
 /1 _ 2700 K
 CRI >90 20370 lm 121 lm/W
 /2 _ 3000 K
 CRI >90 20370 lm 121 lm/W
 /3 _ 3500 K
 CRI >90 21012,8 lm 125,1 lm/W

Control
 0377 _ _ / _ A
 DALI-2, 1-10V, Push
 0377 _ _ / _ Z
 Casambi

Materials
 Diffuser: Pressed-glass. Body: Aluminum.
 Canopy and horizontal rods: Steel.

Light Source and electronics
 42 x LED 4,5 W 700 mA
 Constant Current 700 mA
 100~240V 50/60Hz

Packaging
 2 Boxes
 Total Vol 0,5000 m³
 Gross weight 56 Kg Net weight 46 Kg

Notes
 Configuration layout at vibia.com



0378

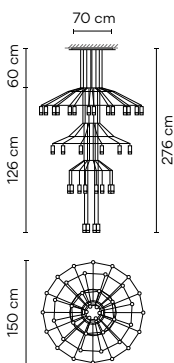

Finishes
 ● 04/ _ _ Black
 (RAL 9005)

LED temperature colour
 /1 _ 2700 K
 CRI >90 20370 lm 121 lm/W
 /2 _ 3000 K
 CRI >90 20370 lm 121 lm/W
 /3 _ 3500 K
 CRI >90 21012,8 lm 125,1 lm/W

Control
 0378 _ _ / _ A
 DALI-2, 1-10V, Push
 0378 _ _ / _ Z
 Casambi

Materials
 Diffuser: Pressed-glass. Body: Aluminum.
 Canopy and horizontal rods: Steel.

Light Source and electronics
 42 x LED 4,5 W 700 mA
 Constant Current 700 mA
 100~240V 50/60Hz

Packaging
 2 Boxes
 Total Vol 0,5000 m³
 Gross weight 56 Kg Net weight 46 Kg

Notes
 Configuration layout at vibia.com



Big

Design by Lievore, Altherr, Molina

Big breaks new ground in terms of scale and technology, revolutionising the ceiling light fitting.

Ceiling

0530 0532

ø 120 cm



0531 0533

ø 100 cm



0530

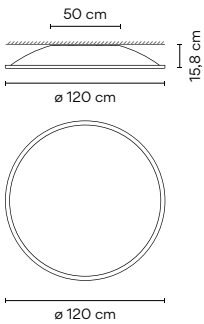

Finishes

- 01 Chrome (Metallic finish)
- 93 White (RAL 9016)

Materials

Shade: Aluminum. Diffuser: Methacrylate.
Ring: Steel.

Light Source and electronics

2 x 2G11 230V 36 W
2 x 2G11 230V 24 W

0530 __

Packaging

1 Box 0,38 x 1,37 x 1,37 m
Vol 0,7080 m³
Gross weight 21 Kg Net weight 18,9 Kg

Notes

Easy-to-install and replace bulb system.

UNTIL STOCK RUNS OUT



0531

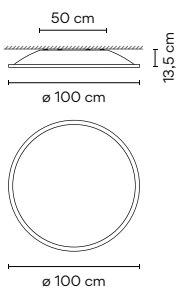

Finishes

- 01 Chrome (Metallic finish)
- 93 White (RAL 9016)

Materials

Shade: Aluminum. Diffuser: Methacrylate.
Ring: Steel.

Light Source and electronics

2 x 2G11 230V 36 W
2 x 2G11 230V 24 W

0531 __

Packaging

1 Box 0,34 x 1,14 x 1,14 m
Vol 0,4420 m³
Gross weight 15,2 Kg Net weight 13,68 Kg

Notes

Easy-to-install and replace bulb system.

UNTIL STOCK RUNS OUT



0532

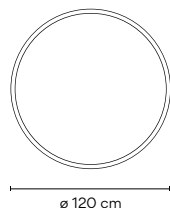
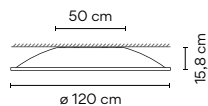

Finishes
 01/ __ Chrome
 (Metallic finish)
 93/ __ White
 (RAL 9016)

LED temperature colour
 /2 3000 K
 CRI >90 8944 lm 132 lm/W

Control
 0532 __ / _ 1
 DALI-2
 0532 __ / _ B
 1-10V, Push
 0532 __ / _ Z
 Casambi

Materials
 Shade: Aluminum. Diffuser: Methacrylate.
 Ring: Steel.
 Light Source and electronics
 4 x LED Quadrant 18,9 W 500 mA
 Constant Current 500 mA
 220-240V 50/60Hz

Packaging
 1 Box 0,38 x 1,36 x 1,36 m
 Vol 0,7080 m³
 Gross weight 21 Kg Net weight 18,9 Kg
 Notes
UNTIL STOCK RUNS OUT

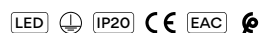

0533

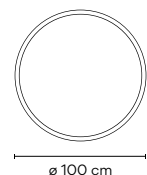
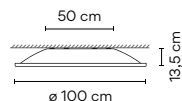

Finishes
 01/ __ Chrome
 (Metallic finish)
 93/ __ White
 (RAL 9016)

LED temperature colour
 /2 3000 K
 CRI >90 8944 lm 132 lm/W

Control
 0533 __ / _ 1
 DALI-2
 0533 __ / _ B
 1-10V, Push
 0533 __ / _ Z
 Casambi

Materials
 Shade: Aluminum. Diffuser: Methacrylate.
 Ring: Steel.
 Light Source and electronics
 4 x LED Quadrant 18,9 W 500 mA
 Constant Current 500 mA
 220-240V 50/60Hz

Packaging
 1 Box 0,34 x 1,14 x 1,14 m
 Vol 0,4420 m³
 Gross weight 15,2 Kg Net weight 13,68 Kg
 Notes
UNTIL STOCK RUNS OUT

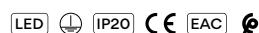

Easy-to-install and
 replace bulb system.



Pendants



ø 120 cm

0530 0532



ø 100 cm

0536 0538

0535

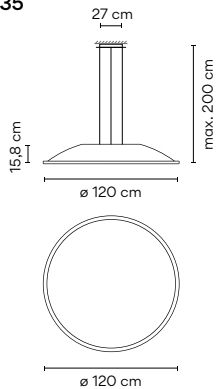

Finishes

- 01 Chrome (Metallic finish)
- 93 White (RAL 9016)

0535 __

Materials

Shade: Aluminum. Diffuser: Methacrylate.
Ring: Steel. Canopy: Steel.

Packaging

1 Box 0,38 x 1,37 x 1,37 m
Vol 0,7080 m³
Gross weight 25,6 Kg Net weight 23,04 Kg

Light Source and electronics

2 x 2G11 230V 36 W
2 x 2G11 230V 24 W

Notes

Easy-to-install and replace bulb system
Extra cable length.

UNTIL STOCK RUNS OUT



0536

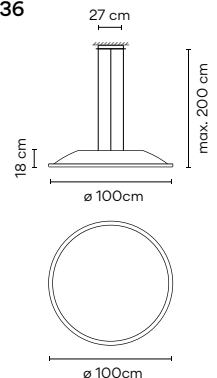

Finishes

- 01 Chrome (Metallic finish)
- 93 White (RAL 9016)

0536 __

Materials

Shade: Aluminum. Diffuser: Methacrylate.
Ring: Steel. Canopy: Steel.

Packaging

1 Box 0,34 x 1,14 x 1,14 m
Vol 0,4420 m³
Gross weight 19,6 Kg Net weight 17,64 Kg

Light Source and electronics

2 x 2G11 230V 36 W
2 x 2G11 230V 24 W

Notes

Easy-to-install and replace bulb system
Extra cable length.

UNTIL STOCK RUNS OUT



1160 10 /1A

Model Finish
LED temperature colour Control



0537

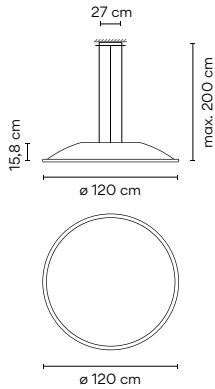

Finishes
 01/ __ Chrome
 (Metallic finish)
 93/ __ White
 (RAL 9016)

LED temperature colour
 /2 3000 K
 CRI >90 8944 lm 132 lm/W

Control
 0537 __ / _ 1
 DALI-2
 0537 __ / _ B
 1-10V, Push
 0537 __ / _ Z
 Casambi

Materials
 Shade: Aluminum. Diffuser: Methacrylate.
 Ring: Steel. Canopy: Steel.
 Light Source and electronics
 4 x LED Quadrant 18,9 W 500 mA
 Constant Current 500 mA
 220-240V 50/60Hz

Packaging
 1 Box 0,38 x 1,36 x 1,36 m
 Vol 0,7080 m³
 Gross weight 25,6 Kg Net weight 23,04 Kg

Notes
 Extra cable length.
 UNTIL STOCK RUNS OUT

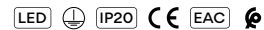

0538

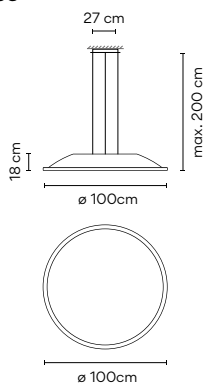

Finishes
 01/ __ Chrome
 (Metallic finish)
 93/ __ White
 (RAL 9016)

LED temperature colour
 /2 3000 K
 CRI >90 8944 lm 132 lm/W

Control
 0538 __ / _ 1
 DALI-2
 0538 __ / _ B
 1-10V, Push
 0538 __ / _ Z
 Casambi

Materials
 Shade: Aluminum. Diffuser: Methacrylate.
 Ring: Steel. Canopy: Steel.
 Light Source and electronics
 4 x LED Quadrant 18,9 W 500mA
 Constant Current 500 mA
 220-240V 50/60Hz

Packaging
 1 Box 0,38 x 1,36 x 1,36 m
 Vol 0,7080 m³
 Gross weight 19,6 Kg Net weight 17,64 Kg

Notes
 Extra cable length.
 UNTIL STOCK RUNS OUT

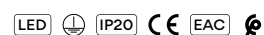

Big Built-in

Design by Lievore, Altherr, Molina

Big reimagines the utilitarian ceiling light with an enlarged diffuser that covers nearly the entire chrome fitting. The simple, oversized shape evokes a glowing orb overhead, its pure, geometric silhouette mimicking the effect of a skylight.

Ceiling

0540

ø 123 cm



0546 0547

ø 36 cm



0543 0544

ø 60 cm



Chrome ring.
Easy-to-install and replace
bulb system.



0540

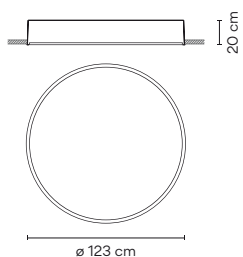

Finishes

- 01 Chrome (Metallic finish)
- 93 White (RAL 9016)

Materials

Diffuser: Methacrylate. Built-in body: Aluminum.
Ring: Steel.

Light Source and electronics

- 2 x G5 230V 24 W (T5)
- 2 x G5 230V 39 W (T5)
- 2 x G5 230V 54 W (T5)

0540 _ _

Packaging

1 Box 0,38 x 1,37 x 1,37 m
Vol 0,7080 m³
Gross weight 23 Kg Net weight 1 Kg

Notes

Built-in

UNTIL STOCK RUNS OUT

IP20 CE EAC ø 121 cm

0543

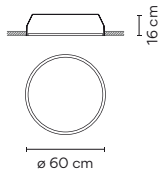

- Finishes
- **01 Chrome**
(Metallic finish)
 - **93 White**
(RAL 9016)

Materials
Diffuser: Methacrylate. Built-in body: Aluminum.
Ring: Steel.

Light Source and electronics
2 x 2G11 230V 24 W
2 x 2G11 230V 36 W

0543 __

Packaging
1 Box 0,27 x 0,76 x 0,76 m
Vol 0,1550 m³
Gross weight 7 Kg Net weight 4,50 Kg

Notes
Built-in
UNTIL STOCK RUNS OUT
⊕ IP20 CE EAC ⚡ ⌀ 58,7 cm

0544

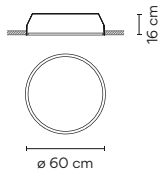

- Finishes
- **01 Chrome**
(Metallic finish)
 - **93 White**
(RAL 9016)

Materials
Diffuser: Methacrylate. Built-in body: Aluminum.
Ring: Steel.

Light Source and electronics
2 x 2G11 230V 24 W
2 x 2G11 230V 36 W

0544 __

Packaging
1 Box 0,27 x 0,76 x 0,76 m
Vol 0,1550 m³
Gross weight 8 Kg Net weight 5 Kg

Notes
Built-in
UNTIL STOCK RUNS OUT
⊕ IP20 CE EAC ⚡ ⌀ 58,7 cm

0546

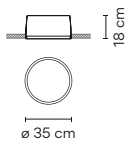

- Finishes
- **01 Chrome**
(Metallic finish)
 - **93 White**
(RAL 9016)

Materials
Diffuser: Methacrylate. Built-in body: Aluminum.
Ring: Steel.

Light Source and electronics
1 x 2GX13 230V 55W (T5C)

0546 __

Packaging
1 Box 0,25 x 0,42 x 0,42 m
Vol 0,0440 m³
Gross weight 2,5 Kg Net weight 2 Kg

Notes
Built-in
UNTIL STOCK RUNS OUT
⊕ IP20 CE EAC ⚡ ⌀ 34 cm

0547

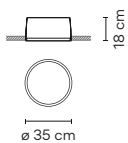

- Finishes
- **01 Chrome**
(Metallic finish)
 - **93 White**
(RAL 9016)

Materials
Diffuser: Methacrylate. Built-in body: Aluminum.
Ring: Steel.

Light Source and electronics
1 x 2GX13 230V 55 W (T5C)

0547 __

Packaging
1 Box 0,25 x 0,42 x 0,42 m
Vol 0,0440 m³
Gross weight 2,5 Kg Net weight 2 Kg

Notes
Built-in
UNTIL STOCK RUNS OUT
⊕ IP20 CE EAC ⚡ ⌀ 34 cm

I.Cono

Design by Lievore, Altherr, Molina

Exuding a poised, Scandinavian presence, I.Cono is distinguished by its signature visor-shaped shade that's sleekly angled for a stylish look. Ideal for precision lighting or reading, its pure and clean design conceals its rotation mechanisms.

Table Floor Wall

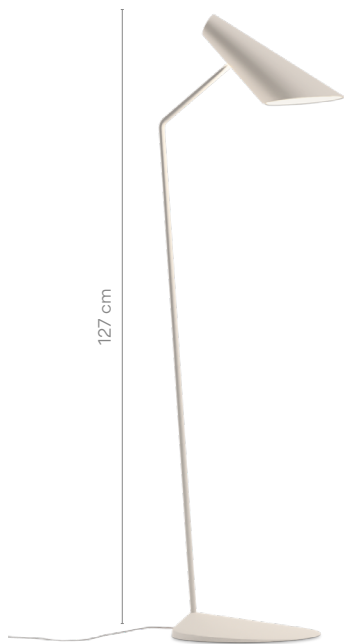

0712



0700



0720

0700

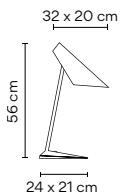

Finishes

- **10 White**
(NCS S 0300-N)
- **21 Black Grey**
(NCS S 7000-N)
- **25 Beige D1**
(NCS S 4005-G80Y)
- **37 Terra Red**
(NCS S 4040-Y70R)
- **42 Blue M1**
(NCS S 5010-B10G)

LED temperature colour

2700 K 800 lm/W

0700 __

Materials

Shade: Polycarbonate. Base: Zamak.
Vertical tube: Steel.

Light Source and electronics

1 x LED E14 230V 7 W

Packaging

1 Box 0,81 x 0,31 x 0,33 m
Vol 0,0828 m³
Gross weight 5,2 Kg Net weight 3,2 Kg

Notes

Switch on the base.
Electric cable 2 m



0712

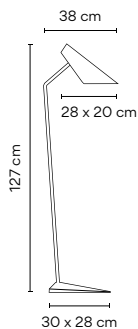

- Finishes
- 10 White (NCS S 0300-N)
 - 21 Black Grey (NCS S 7000-N)
 - 25 Beige D1 (NCS S 4005-G80Y)
 - 37 Terra Red (NCS S 4040-Y70R)
 - 42 Blue M1 (NCS S 5010-B10G)
- LED temperature colour
2700 K 800 lm/W

0712 __

Materials

Shade: Polycarbonate. Base: Zamak.
Vertical tube: Steel.

Light Source and electronics

1 x LED E14 230V 7 W

Packaging

1 Box 0,34 x 1,50 x 0,32 m
Vol 0,1632 m³
Gross weight 16 Kg Net weight 11,8 Kg

Notes

Switch on the cable.
Electric cable 1,5 m



0720

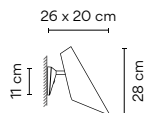

- Finishes
- 10 White (NCS S 0300-N)
 - 21 Black Grey (NCS S 7000-N)
 - 25 Beige D1 (NCS S 4005-G80Y)
 - 37 Terra Red (NCS S 4040-Y70R)
 - 42 Blue M1 (NCS S 5010-B10G)
- LED temperature colour
2700 K 800 lm/W

0720 __

Materials

Shade: Polycarbonate.
Wall plate: Zamak.

Light Source and electronics

1 x LED E14 230V 7 W

Packaging

1 Box 0,21 x 0,48 x 0,21 m
Vol 0,0212 m³
Gross weight 2,2 Kg Net weight 1 Kg

Notes

On/off switch on the wall plate



Algorithm Free

Design by Toan Nguyen

Like a cloud of frozen rain, this collection brings together beauty and geometry. Mathematical order provides a magical harmony with an astonishing range of permutations and compositions. Can be customized to suit any space.

Pendants

* Built-in version

0820 *0822

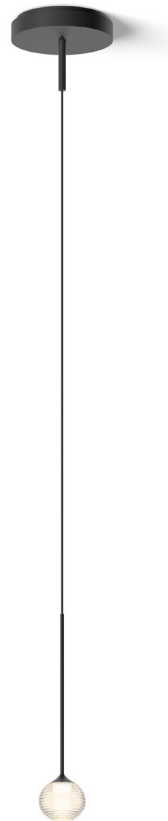

0820

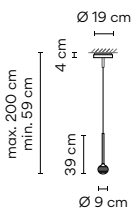

Finishes	LED temperature colour
● 18/ _ _ Graphite (ADAPTA RF9913WX)	/1_ 2700 K E → CRI >90 312,28 lm 90 lm/W
● 93/ _ _ White (RAL 9016)	/3_ 3500 K F → CRI >90 312,3 lm 99,1 lm/W

Materials
Ball: Blowed glass. Glass fixation: Aluminum.
Ceiling rose: Steel. Diffuser: PC. Pendant structure: Steel.

Light Source and electronics
1 x LED 3,15 W 1050 mA
Constant Current 1050 mA
100~240V 50/60Hz

Control
0820 _ / _ **A**
DALI-2, 1-10V, Push
0820 _ / _ **Z**
Casambi

Packaging
1 Box 0,18 x 0,55 x 0,55 m
Vol 0,0131 m³
Gross weight 2,17 Kg Net weight 1,57 Kg

Notes
Surface.
Extra cable length. **16,00 €/m**



Electrical connection
Surface
_18 Free Wire
_23 Built-in
_31 Remote Micro
for plaster ceilings
_32 Remote XXS
for all types of drop ceilings

1160 10 /1A _18

Model
Finish
LED temperature colour
Control
Electrical connection
Only for pendants



0822

Finishes

- 18/ _ _ Graphite (ADAPTA RF9913WX)
- 93/ _ _ White (RAL 9016)

LED temperature colour

- /1_ 2700 K
- CRI >90 312,28 lm 90 lm/W
- /3 3500 K
- CRI >90 312,3 lm 99,1 lm/W

Control

0822 _ _ / A
DALI-2, 1-10V, Push

0822 _ _ / Z
Casambi

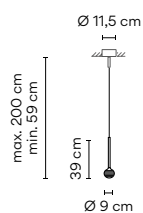

Materials

Ball: Blowed glass. Glass fixation: Aluminum.
Ceiling rose: Steel. Diffuser: PC. Pendant structure: Steel.

Light Source and electronics

1 x LED 3,15 W 1050 mA
Constant Current 1050 mA
100~240V 50/60Hz

Packaging

1 Box 0,18 x 0,55 x 0,55 m
Vol 0,0131 m³
Gross weight 2,17 Kg Net weight 1,57 Kg

Notes

Built-in.
Extra cable length.
UNTIL STOCK RUNS OUT

LED IP20 CE EAC

Bi-volt ø 10,5 cm

Composing pendants

Next sketches are composed by one or more compositions

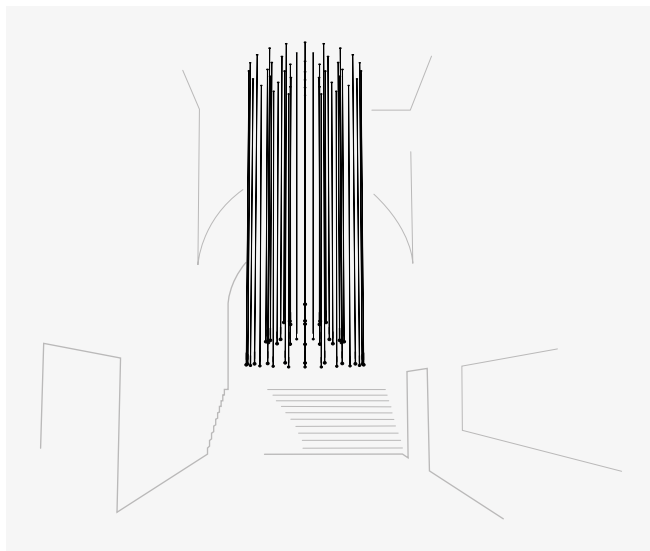

52 x 0820.

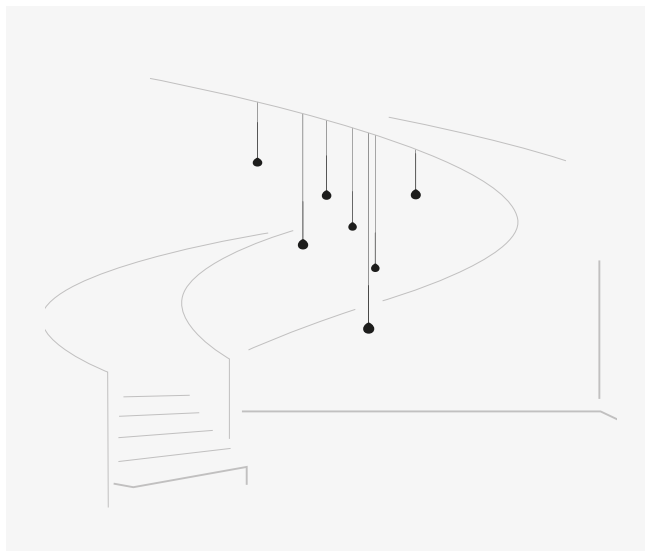

7 x 0820.

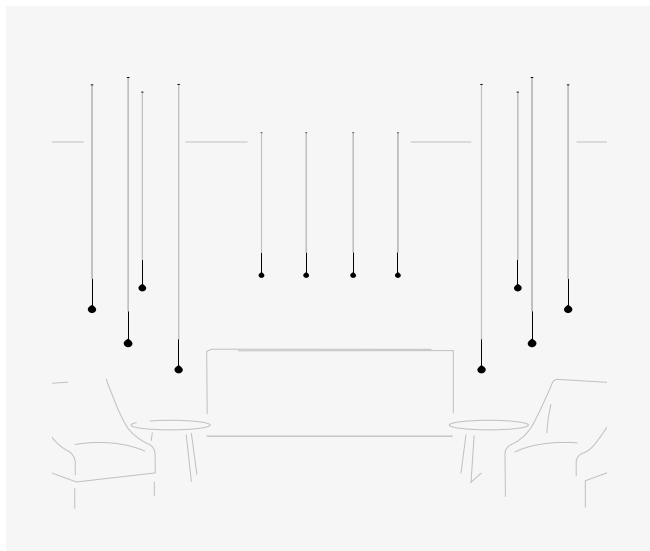

12 x 0820.

Each project is unique.
Visit vibia.com and
chose among multiple
compositions designed
and adapted to your
project needs.

Personalise your own
Algorithm composition quick
and easy at vibia.com



Electrical connection options for model 0820

Drop ceiling

The innovative remote and built-in fittings accentuate the silkiness and lightness of compositions on suspended ceilings, its great visual grandeur taking center stage.

For Ref. 0820

Remote

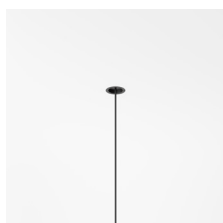

Micro \varnothing 3 cm
height 7 cm
for plaster ceilings.
Black finish.

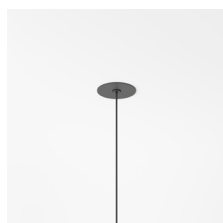
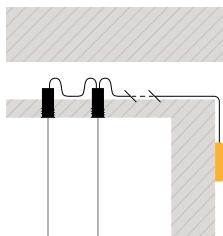

XXS \varnothing 6 cm
height 6 cm
for all types of drop
ceilings. Match with
fixture finish.

Built-in



\varnothing 8 cm
height 6 cm
match with
fixture finish.

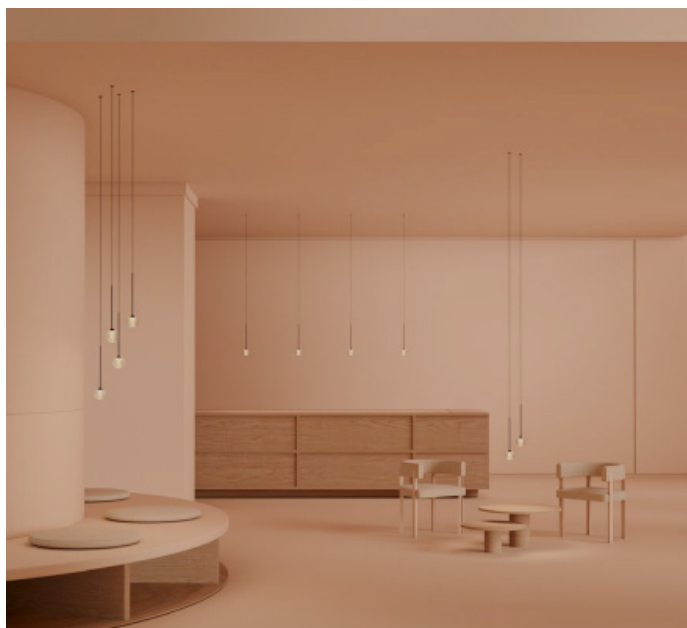
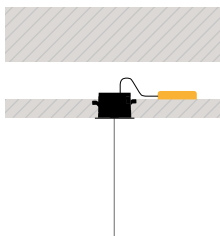

Regular ceiling

When architecture does not allow for performance, surface and free wire showcase possibilities for any need or desire with no limits, ideal for both individual or cluster arrangements.

For Ref. 0820

Surface



ø 19 cm

match with
fixture finish.

Free Wire

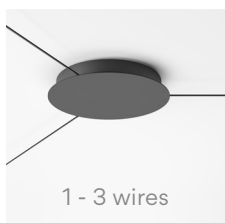

1 - 3 wires

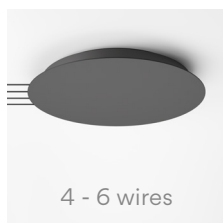

4 - 6 wires

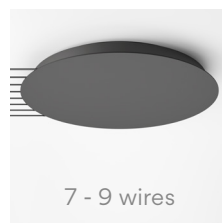

7 - 9 wires

ø 22 cm

ø 36 cm

ø 40 cm

you can choose the finish of the canopy
among black, white or any colour
matching one of the pendants.

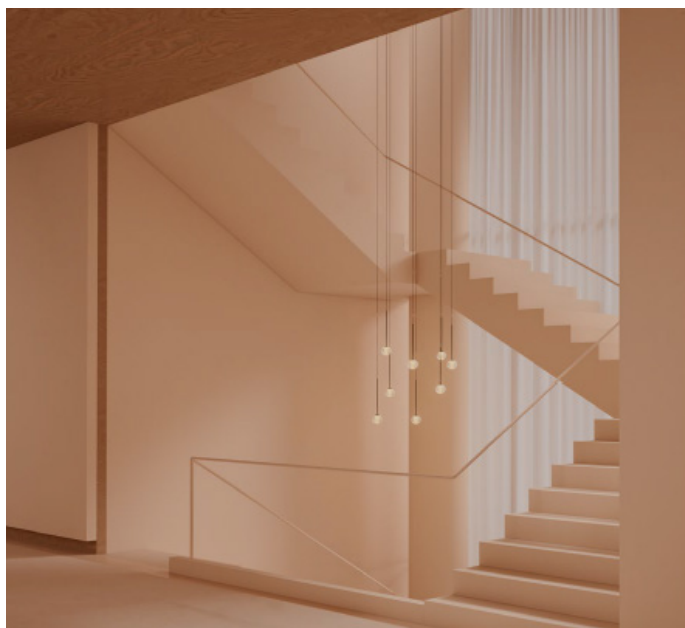
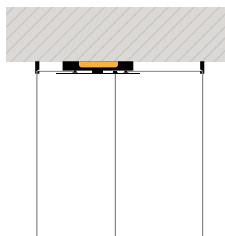
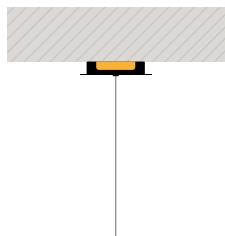

Algorithm Grid

Design by Toan Nguyen

Like a cloud of frozen rain, this collection brings together beauty and geometry. Mathematical order provides a magical harmony with an astonishing range of permutations and compositions. Can be customized to suit any space.

Pendants

* Built-in version



75 cm

0825 *0827

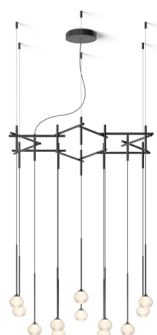

89 cm

0880 *0882



160 cm

0885 *0887

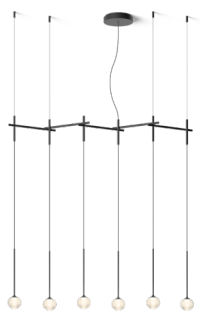

123 cm

0830 *0832

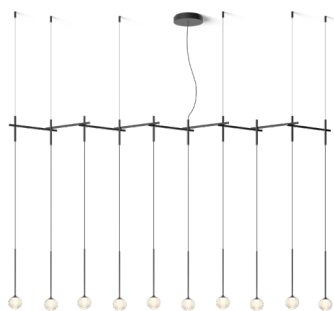

214 cm

0835 *0837

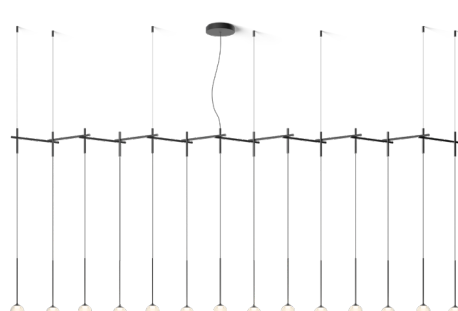

305 cm

0840 *0842



183 cm

0845 *0847



399 cm

0850 *0852



60 cm

0855 *0857

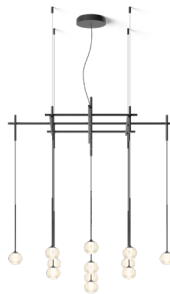

110 cm

0860 *0862



160 cm

0865 *0867

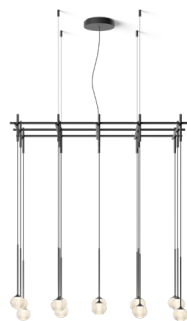

110 cm

0870 *0872

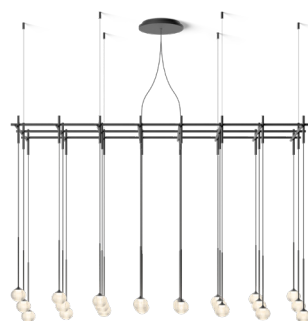

185 cm

0875 *0877

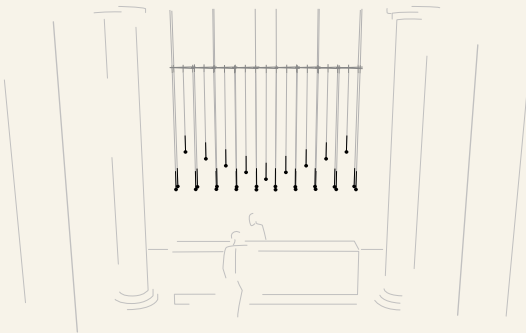
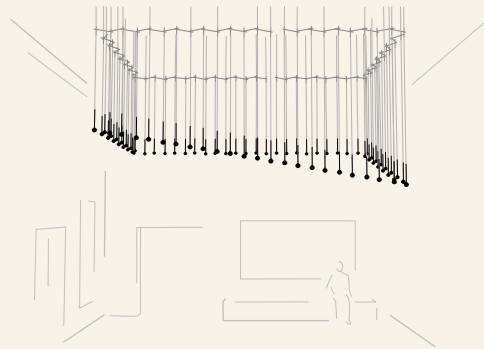
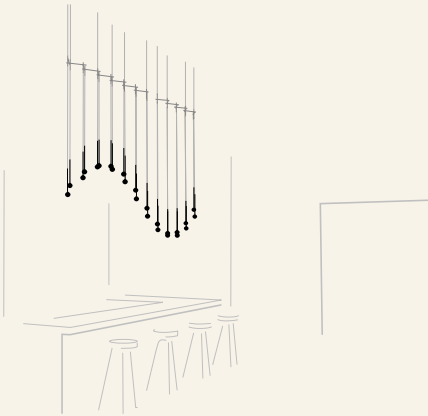
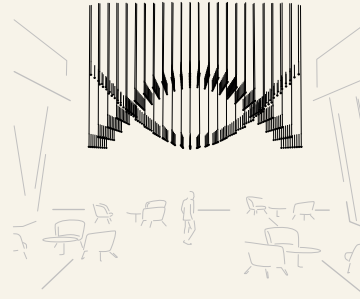
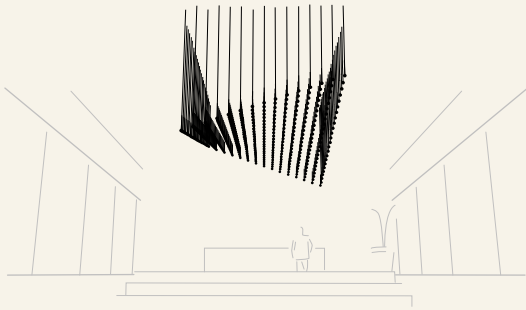

Surface.

Built-in.
11,5 cm Die-cut diameter,
12 cm minimum height in ceiling.

Adjustable cable installation.

Rigid stem installation.
Fixed at 25 cm.

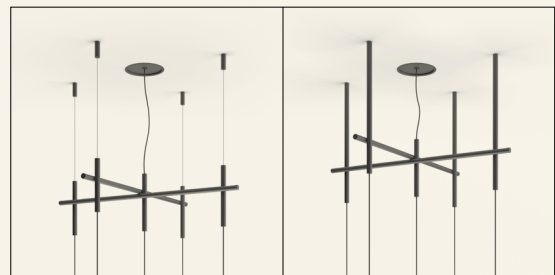
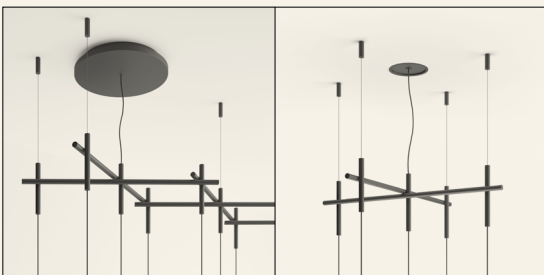

Adjust height of standard model

To personalize luminaire height, without adjusting diffusers layout.

The steel cables that go from the structure to the ceiling are the only ones that allow the height of the lamp to be adjusted. The installation manual describes how to do this and how to cut the cables.

Personalise your own Algorithm composition quick and easy at vibia.com

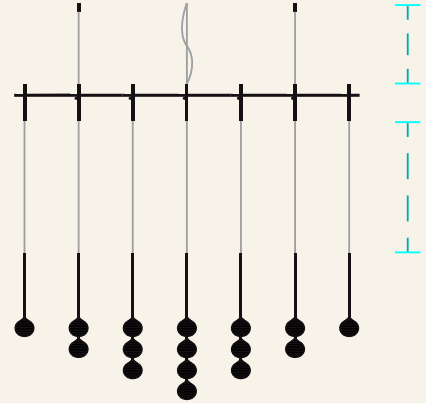

0825

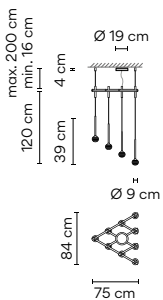

Finishes

- 18/ __ Graphite (ADAPTA RF9913WX)
- 93/ __ White (RAL 9016)

LED temperature colour

- /1 _ 2700 K CRI >90 3122,8 lm 99 lm/W
- /3 _ 3500 K CRI >90 3122,8 lm 99,1 lm/W

Control

- 0825 __ / _ A DALI-2, 1-10V, Push
- 0825 __ / _ Z Casambi

Materials

Ball: Blowed glass. Glass fixation: Aluminum.
 Ceiling rose: Steel. Diffuser: PC. Pendant structure: Steel.

Light Source and electronics

10 x LED 3,15 W 1050 mA
 Constant Current 1050 mA
 100~240V 50/60Hz

Packaging

2 Boxes
 Total Vol. 0,324 m³
 Gross weight 15,5 Kg Net weight 10,5 Kg

Notes

Surface



0827

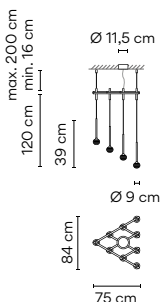

Finishes

- 18/ __ Graphite (ADAPTA RF9913WX)
- 93/ __ White (RAL 9016)

LED temperature colour

- /1 _ 2700 K CRI >90 3122,8 lm 99 lm/W
- /3 _ 3500 K CRI >90 3122,8 lm 99,1 lm/W

Control

- 0827 __ / _ A DALI-2, 1-10V, Push
- 0827 __ / _ Z Casambi

Materials

Ball: Blowed glass. Glass fixation: Aluminum.
 Ceiling rose: Steel. Diffuser: PC. Pendant structure: Steel.

Light Source and electronics

10 x LED 3,15 W 1050 mA
 Constant Current 1050 mA
 100~240V 50/60Hz

Packaging

2 Boxes
 Total Vol. 0,324 m³
 Gross weight 15,5 Kg Net weight 10,5 Kg

Notes

Built-in

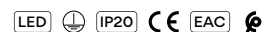

Bi-volt ø 10,5 cm

0830

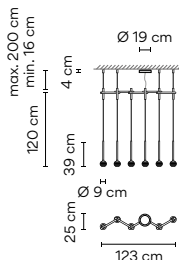

- | | |
|---|--|
| <p>Finishes</p> <ul style="list-style-type: none"> ● 18/ _ _ Graphite (ADAPTA RF9913WX) ● 93/ _ _ White (RAL 9016) | <p>LED temperature colour</p> <ul style="list-style-type: none"> /1 _ 2700 K CRI >90 1873,68 lm 99 lm/W /3 _ 3500 K CRI >90 1873,7 lm 99,1 lm/W |
|---|--|

- Control**
- 0830** _ / _ A
DALI-2, 1-10V, Push
- 0830** _ / _ Z
Casambi

Materials
Ball: Blowed glass. Glass fixation: Aluminum.
Ceiling rose: Steel. Diffuser: PC. Pendant structure: Steel.

Light Source and electronics
6 x LED 3,15 W 1050 mA
Constant Current 1050 mA
100~240V 50/60Hz

Packaging
2 Boxes
Total Vol. 0,1705 m³
Gross weight 3,5 Kg Net weight 5,8 Kg

Notes
Surface

0832

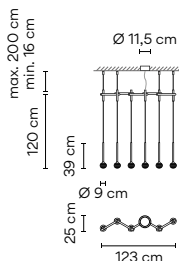

- | | |
|---|--|
| <p>Finishes</p> <ul style="list-style-type: none"> ● 18/ _ _ Graphite (ADAPTA RF9913WX) ● 93/ _ _ White (RAL 9016) | <p>LED temperature colour</p> <ul style="list-style-type: none"> /1 _ 2700 K CRI >90 1873,68 lm 99 lm/W /3 _ 3500 K CRI >90 1873,7 lm 99,1 lm/W |
|---|--|

- Control**
- 0832** _ / _ A
DALI-2, 1-10V, Push
- 0832** _ / _ Z
Casambi

Materials
Ball: Blowed glass. Glass fixation: Aluminum.
Ceiling rose: Steel. Diffuser: PC. Pendant structure: Steel.

Light Source and electronics
6 x LED 3,15 W 1050 mA
Constant Current 1050 mA
100~240V 50/60Hz

Packaging
2 Boxes
Total Vol. 0,1705 m³
Gross weight 3,5 Kg Net weight 5,8 Kg

Notes
Built-in

ø 10,5 cm

0835

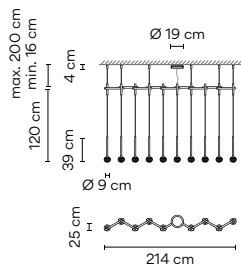

- | | |
|---|---|
| <p>Finishes</p> <ul style="list-style-type: none"> ● 18/ _ _ Graphite (ADAPTA RF9913WX) ● 93/ _ _ White (RAL 9016) | <p>LED temperature colour</p> <ul style="list-style-type: none"> /1 _ 2700 K CRI >90 3122,8 lm 99 lm/W /3 _ 3500 K CRI >90 3122,8 lm 99,1 lm/W |
|---|---|

- Control**
- 0835** _ / _ A
DALI-2, 1-10V, Push
- 0835** _ / _ Z
Casambi

Materials
Ball: Blowed glass. Glass fixation: Aluminum.
Ceiling rose: Steel. Diffuser: PC. Pendant structure: Steel.

Light Source and electronics
10 x LED 3,15 W 1050 mA
Constant Current 1050 mA
100~240V 50/60Hz

Packaging
2 Boxes
Total Vol. 0,3220 m³
Gross weight 15,5 Kg Net weight 10,5 Kg

Notes
Surface

0837

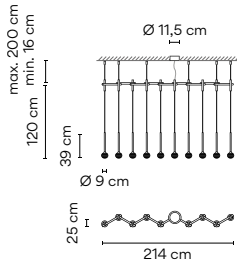

- Finishes**
- 18/ _ _ Graphite (ADAPTA RF9913WX)
 - 93/ _ _ White (RAL 9016)
- LED temperature colour**
- /1 _ 2700 K CRI >90 3122,8 lm 99 lm/W
 - /3 _ 3500 K CRI >90 3122,8 lm 99,1 lm/W

- Control**
- 0837 _ _ / _ A DALI-2, 1-10V, Push
 - 0837 _ _ / _ Z Casambi

Materials
 Ball: Blowed glass. Glass fixation: Aluminum.
 Ceiling rose: Steel. Diffuser: PC. Pendant structure: Steel.

Light Source and electronics
 10 x LED 3,15 W 1050 mA
 Constant Current 1050 mA
 100~240V 50/60Hz

Packaging
 2 Boxes
 Total Vol. 0,3220 m³
 Gross weight 15,5 Kg Net weight 10,5 Kg

Notes
 Built-in

ø 10,5 cm

0840

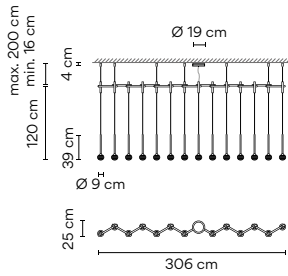

- Finishes**
- 18/ _ _ Graphite (ADAPTA RF9913WX)
 - 93/ _ _ White (RAL 9016)
- LED temperature colour**
- /1 _ 2700 K CRI >90 4371,92 lm 99 lm/W
 - /3 _ 3500 K CRI >90 4371,92 lm 99,1 lm/W

- Control**
- 0840 _ _ / _ A DALI-2, 1-10V, Push
 - 0840 _ _ / _ Z Casambi

Materials
 Ball: Blowed glass. Glass fixation: Aluminum.
 Ceiling rose: Steel. Diffuser: PC. Pendant structure: Steel.

Light Source and electronics
 14 x LED 3,15 W 1050 mA
 Constant Current 1050 mA
 100~240V 50/60Hz

Packaging
 3 Boxes
 Total Vol. 0,5275 m³
 Gross weight 17,3 Kg Net weight 11,3 Kg

Notes
 Surface

0842

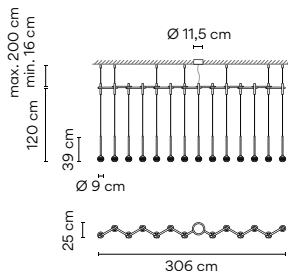

- Finishes**
- 18/ _ _ Graphite (ADAPTA RF9913WX)
 - 93/ _ _ White (RAL 9016)
- LED temperature colour**
- /1 _ 2700 K CRI >90 4371,92 lm 99 lm/W
 - /3 _ 3500 K CRI >90 4371,92 lm 99,1 lm/W

- Control**
- 0842 _ _ / _ A DALI-2, 1-10V, Push
 - 0842 _ _ / _ Z Casambi

Materials
 Ball: Blowed glass. Glass fixation: Aluminum.
 Ceiling rose: Steel. Diffuser: PC. Pendant structure: Steel.

Light Source and electronics
 14 x LED 3,15 W 1050 mA
 Constant Current 1050 mA
 100~240V 50/60Hz

Packaging
 3 Boxes
 Total Vol. 0,5275 m³
 Gross weight 17,3 Kg Net weight 11,3 Kg

Notes
 Built-in

ø 10,5 cm

0845

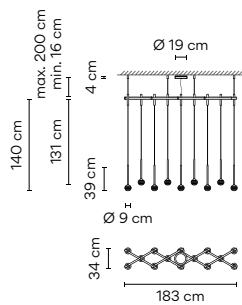

- Finishes**
- **18/** __ Graphite (ADAPTA RF9913WX)
 - **93/** __ White (RAL 9016)
- LED temperature colour**
- /1_ 2700 K
 - CRI >90 4371,92 lm 99 lm/W
 - /3_ 3500 K
 - CRI >90 4371,92 lm 99,1 lm/W

- Control**
- 0845** __ / __ A
 - DALI-2, 1-10V, Push
 - 0845** __ / __ Z
 - Casambi

Materials
 Ball: Blowed glass. Glass fixation: Aluminum.
 Ceiling rose: Steel. Diffuser: PC. Pendant structure: Steel.

Light Source and electronics
 14 x LED 3,15 W 1050 mA
 Constant Current 1050 mA
 100~240V 50/60Hz

Packaging
 2 Boxes
 Total Vol. 0,3220 m³
 Gross weight 18,3 Kg Net weight 13,3 Kg

Notes
 Surface

0847

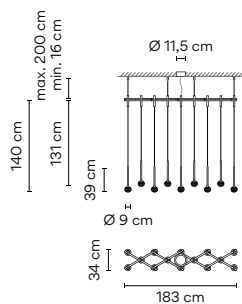

- Finishes**
- **18/** __ Graphite (ADAPTA RF9913WX)
 - **93/** __ White (RAL 9016)
- LED temperature colour**
- /1_ 2700 K
 - CRI >90 4371,92 lm 99 lm/W
 - /3_ 3500 K
 - CRI >90 4371,92 lm 99,1 lm/W

- Control**
- 0847** __ / __ A
 - DALI-2, 1-10V, Push
 - 0847** __ / __ Z
 - Casambi

Materials
 Ball: Blowed glass. Glass fixation: Aluminum.
 Ceiling rose: Steel. Diffuser: PC. Pendant structure: Steel.

Light Source and electronics
 14 x LED 3,15 W 1050 mA
 Constant Current 1050 mA
 100~240V 50/60Hz

Packaging
 2 Boxes
 Total Vol. 0,3220 m³
 Gross weight 18,3 Kg Net weight 13,3 Kg

Notes
 Built-in

ø 10,5 cm

0850

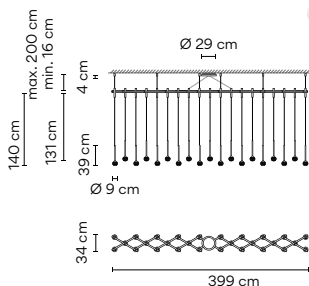

- Finishes**
- **18/** __ Graphite (ADAPTA RF9913WX)
 - **93/** __ White (RAL 9016)
- LED temperature colour**
- /1_ 2700 K
 - CRI >90 9056,12 lm 99 lm/W
 - /3_ 3500 K
 - CRI >90 9056,12 lm 99,1 lm/W

- Control**
- 0850** __ / __ A
 - DALI-2, 1-10V, Push
 - 0850** __ / __ Z
 - Casambi

Materials
 Ball: Blowed glass. Glass fixation: Aluminum.
 Ceiling rose: Steel. Diffuser: PC. Pendant structure: Steel.

Light Source and electronics
 29 x LED 3,15 W 1050 mA
 Constant Current 1050 mA
 100~240V 50/60Hz

Packaging
 2 Boxes
 Total Vol. 0,6260 m³
 Gross weight 26 Kg Net weight 20 Kg

Notes
 Surface

0852

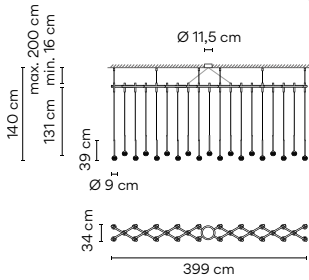

Finishes	LED temperature colour
● 18/ _ _ Graphite (ADAPTA RF9913WX)	/1_ 2700 K
● 93/ _ _ White (RAL 9016)	/3_ 3500 K
	CRI >90 9056,12 lm 99 lm/W
	CRI >90 9056,12 lm 99,1 lm/W

Control
0852 _ _ / _ A DALI-2, 1-10V, Push
0852 _ _ / _ Z Casambi

Materials
 Ball: Blowed glass. Glass fixation: Aluminum.
 Ceiling rose: Steel. Diffuser: PC. Pendant structure: Steel.

Light Source and electronics
 29 x LED 3,15 W 1050 mA
 Constant Current 1050 mA
 100~240V 50/60Hz

Packaging
 2 Boxes
 Total Vol. 0,6260 m³
 Gross weight 26 Kg Net weight 20 Kg

Notes
 Built-in

 Bi-volt ø 10,5 cm

0855

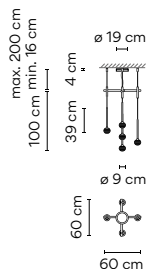

Finishes	LED temperature colour
● 18/ _ _ Graphite (ADAPTA RF9913WX)	/1_ 2700 K
● 93/ _ _ White (RAL 9016)	/3_ 3500 K
	CRI >90 1561,4 lm 99 lm/W
	CRI >90 1130,4 lm 71,8 lm/W

Control
0855 _ _ / _ A DALI-2, 1-10V, Push
0855 _ _ / _ Z Casambi

Materials
 Ball: Blowed glass. Glass fixation: Aluminum.
 Ceiling rose: Steel. Diffuser: PC. Pendant structure: Steel.

Light Source and electronics
 5 x LED 3,15 W 1050 mA
 Constant Current 1050 mA
 100~240V 50/60Hz

Packaging
 2 Boxes
 Total Vol. 0,115 m³
 Gross weight 8,5 Kg Net weight 5,8 Kg

Notes
 Surface.
UNTIL STOCK RUNS OUT

 Dimmer Bi-volt

0857

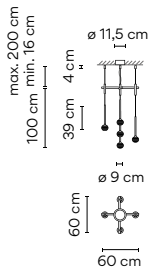

Finishes	LED temperature colour
● 18/ _ _ Graphite (ADAPTA RF9913WX)	/1_ 2700 K
● 93/ _ _ White (RAL 9016)	/3_ 3500 K
	CRI >90 1561,4 lm 99 lm/W
	CRI >90 1130,4 lm 71,8 lm/W

Control
0857 _ _ / _ A DALI-2, 1-10V, Push
0857 _ _ / _ Z Casambi

Materials
 Ball: Blowed glass. Glass fixation: Aluminum.
 Ceiling rose: Steel. Diffuser: PC. Pendant structure: Steel.

Light Source and electronics
 5 x LED 3,15 W 1050 mA
 Constant Current 1050 mA
 100~240V 50/60Hz

Packaging
 2 Boxes
 Total Vol. 0,115 m³
 Gross weight 8,5 Kg Net weight 5,8 Kg

Notes
 Built-in.
UNTIL STOCK RUNS OUT

 Bi-volt ø 10,5 cm

0860

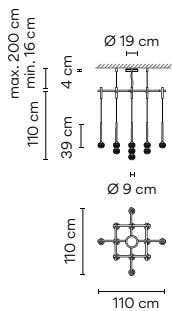

<p>Finishes</p> <ul style="list-style-type: none"> ● 18/ _ _ Graphite (ADAPTA RF9913WX) ● 93/ _ _ White (RAL 9016) 	<p>LED temperature colour</p> <ul style="list-style-type: none"> /1 _ 2700 K CRI >90 4059,64 lm 99 lm/W /3 _ 3500 K CRI >90 4059,64 lm 99,1 lm/W 	<p>Control</p> <p>0860 _ _ / _ A DALI-2, 1-10V, Push</p> <p>0860 _ _ / _ Z Casambi</p>
---	---	---

<p>Materials</p> <p>Ball: Blowed glass. Glass fixation: Aluminum. Ceiling rose: Steel. Diffuser: PC. Pendant structure: Steel.</p> <p>Light Source and electronics</p> <p>13 x LED 3,15 W 1050 mA Constant Current 1050 mA 100~240V 50/60Hz</p>	<p>Packaging</p> <p>2 Boxes Total Vol. 0,3290 m³ Gross weight 17,35 Kg Net weight 11,85 Kg</p> <p>Notes</p> <p>Surface</p> <p> </p>
---	--

0862

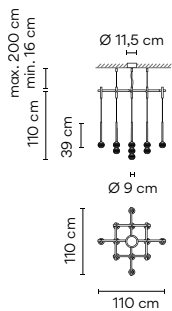

<p>Finishes</p> <ul style="list-style-type: none"> ● 18/ _ _ Graphite (ADAPTA RF9913WX) ● 93/ _ _ White (RAL 9016) 	<p>LED temperature colour</p> <ul style="list-style-type: none"> /1 _ 2700 K CRI >90 4059,64 lm 99 lm/W /3 _ 3500 K CRI >90 4059,64 lm 99,1 lm/W 	<p>Control</p> <p>0862 _ _ / _ A DALI-2, 1-10V, Push</p> <p>0862 _ _ / _ Z Casambi</p>
---	---	---

<p>Materials</p> <p>Ball: Blowed glass. Glass fixation: Aluminum. Ceiling rose: Steel. Diffuser: PC. Pendant structure: Steel.</p> <p>Light Source and electronics</p> <p>13 x LED 3,15 W 1050 mA Constant Current 1050 mA 100~240V 50/60Hz</p>	<p>Packaging</p> <p>2 Boxes Total Vol. 0,3290 m³ Gross weight 17,35 Kg Net weight 11,85 Kg</p> <p>Notes</p> <p>Built-in</p> <p> </p>
---	---

0865

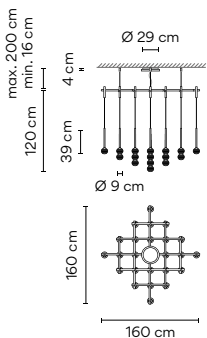

<p>Finishes</p> <ul style="list-style-type: none"> ● 18/ _ _ Graphite (ADAPTA RF9913WX) ● 93/ _ _ White (RAL 9016) 	<p>LED temperature colour</p> <ul style="list-style-type: none"> /1 _ 2700 K CRI >90 7807 lm 99 lm/W /3 _ 3500 K CRI >90 7807 lm 99,1 lm/W 	<p>Control</p> <p>0865 _ _ / _ A DALI-2, 1-10V, Push</p> <p>0865 _ _ / _ Z Casambi</p>
---	---	---

<p>Materials</p> <p>Ball: Blowed glass. Glass fixation: Aluminum. Ceiling rose: Steel. Diffuser: PC. Pendant structure: Steel.</p> <p>Light Source and electronics</p> <p>25 x LED 3,15 W 1050 mA Constant Current 1050 mA 100~240V 50/60Hz</p>	<p>Packaging</p> <p>2 Boxes Total Vol. 0,7280 m³ Gross weight 25,25 Kg Net weight 20,25 Kg</p> <p>Notes</p> <p>Surface</p> <p> </p>
---	--

0867

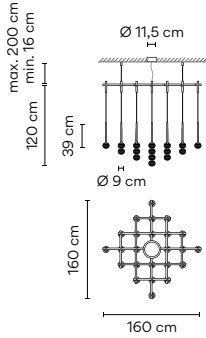

Finishes	LED temperature colour
● 18/ _ _ Graphite (ADAPTA RF9913WX)	/1 _ 2700 K CRI >90 7807 lm 99 lm/W
● 93/ _ _ White (RAL 9016)	/3 _ 3500 K CRI >90 7807 lm 99,1 lm/W

Control
0867 _ _ / _ A DALI-2, 1-10V, Push
0867 _ _ / _ Z Casambi

Materials
 Ball: Blowed glass. Glass fixation: Aluminum.
 Ceiling rose: Steel. Diffuser: PC. Pendant structure: Steel.

Light Source and electronics
 25 x LED 3,15 W 1050 mA
 Constant Current 1050 mA
 100~240V 50/60Hz

Packaging
 2 Boxes
 Total Vol. 0,7280 m³
 Gross weight 25,25 Kg Net weight 20,25 Kg

Notes
 Built-in
 ø 10,5 cm

0870

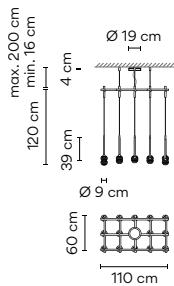

Finishes	LED temperature colour
● 18/ _ _ Graphite (ADAPTA RF9913WX)	/1 _ 2700 K CRI >90 4684,2 lm 99 lm/W
● 93/ _ _ White (RAL 9016)	/3 _ 3500 K CRI >90 4684,2 lm 99,1 lm/W

Control
0870 _ _ / _ A DALI-2, 1-10V, Push
0870 _ _ / _ Z Casambi

Materials
 Ball: Blowed glass. Glass fixation: Aluminum.
 Ceiling rose: Steel. Diffuser: PC. Pendant structure: Steel.

Light Source and electronics
 15 x LED 3,15 W 1050 mA
 Constant Current 1050 mA
 100~240V 50/60Hz

Packaging
 2 Boxes
 Total Vol. 0,2679 m³
 Gross weight 18,25 Kg Net weight 13,75 Kg

Notes
 Surface

0872

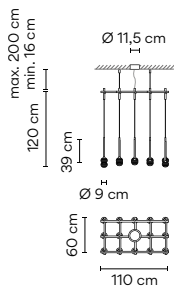

Finishes	LED temperature colour
● 18/ _ _ Graphite (ADAPTA RF9913WX)	/1 _ 2700 K CRI >90 4684,2 lm 99 lm/W
● 93/ _ _ White (RAL 9016)	/3 _ 3500 K CRI >90 4684,2 lm 99,1 lm/W

Control
0872 _ _ / _ A DALI-2, 1-10V, Push
0872 _ _ / _ Z Casambi

Materials
 Ball: Blowed glass. Glass fixation: Aluminum.
 Ceiling rose: Steel. Diffuser: PC. Pendant structure: Steel.

Light Source and electronics
 15 x LED 3,15 W 1050 mA
 Constant Current 1050 mA
 100~240V 50/60Hz

Packaging
 2 Boxes
 Total Vol. 0,2679 m³
 Gross weight 18,25 Kg Net weight 13,75 Kg

Notes
 Built-in
 ø 10,5 cm

0875

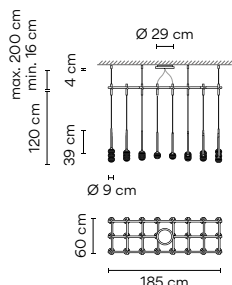

Finishes
 ● 18/ __ Graphite (ADAPTA RF9913WX)
 ● 93/ __ White (RAL 9016)

LED temperature colour
 /1_ 2700 K **F**
 CRI >90 7494,72 lm 99 lm/W
 /3_ 3500 K **F**
 CRI >90 7494,72 lm 99,1 lm/W

Control
 0875 __ / __ A
 DALI-2, 1-10V, Push
 0875 __ / __ Z
 Casambi

Materials
 Ball: Blowed glass. Glass fixation: Aluminum.
 Ceiling rose: Steel. Diffuser: PC. Pendant structure: Steel.

Packaging
 2 Boxes
 Total Vol. 0,4500 m³
 Gross weight 30,1 Kg Net weight 22,1 Kg

Light Source and electronics
 24 x LED 3,15 W 1050 mA
 Constant Current 1050 mA
 100~240V 50/60Hz

Notes
 Surface
 LED IP20 Bi-volt

0877

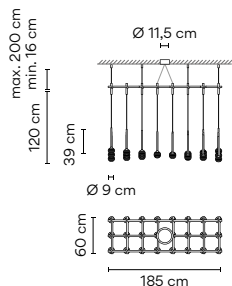

Finishes
 ● 18/ __ Graphite (ADAPTA RF9913WX)
 ● 93/ __ White (RAL 9016)

LED temperature colour
 /1_ 2700 K **F**
 CRI >90 7494,72 lm 99 lm/W
 /3_ 3500 K **F**
 CRI >90 7494,72 lm 99,1 lm/W

Control
 0877 __ / __ A
 DALI-2, 1-10V, Push
 0877 __ / __ Z
 Casambi

Materials
 Ball: Blowed glass. Glass fixation: Aluminum.
 Ceiling rose: Steel. Diffuser: PC. Pendant structure: Steel.

Packaging
 2 Boxes
 Total Vol. 0,4500 m³
 Gross weight 30,1 Kg Net weight 22,1 Kg

Light Source and electronics
 24 x LED 3,15 W 1050 mA
 Constant Current 1050 mA
 100~240V 50/60Hz

Notes
 Built-in
 LED IP20 Bi-volt ø 10,5 cm

0880

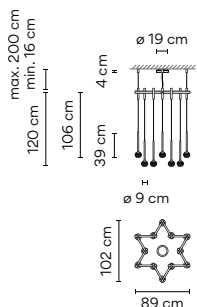

Finishes
 ● 18/ __ Graphite (ADAPTA RF9913WX)
 ● 93/ __ White (RAL 9016)

LED temperature colour
 /1_ 2700 K **F**
 CRI >90 3747,4 lm 99 lm/W
 /3_ 3500 K **G**
 CRI >90 2712,9 lm 71,8 lm/W

Control
 0880 __ / __ A
 DALI-2, 1-10V, Push
 0880 __ / __ Z
 Casambi

Materials
 Ball: Blowed glass. Glass fixation: Aluminum.
 Ceiling rose: Steel. Diffuser: PC. Pendant structure: Steel.

Packaging
 2 Boxes
 Total Vol. 0,3290 m³
 Gross weight 16,5 Kg Net weight 11,4 Kg

Light Source and electronics
 12 x LED 3,15W 1050 mA
 Constant Current 1050 mA
 100~240V 50/60Hz

Notes
 Surface.
UNTIL STOCK RUNS OUT
 LED IP20 Bi-volt

0882

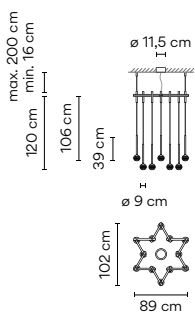

Finishes	LED temperature colour	Control
● 18/ __ Graphite (ADAPTA RF9913WX)	/1_ 2700 K F CRI >90 3747,4 lm 99 lm/W	0882 __ / __ A DALI-2, 1-10V, Push
● 93/ __ White (RAL 9016)	/3_ 3500 K G CRI >90 2712,9 lm 71,8 lm/W	0882 __ / __ Z Casambi

Materials

Ball: Blowed glass. Glass fixation: Aluminum.
 Ceiling rose: Steel. Diffuser: PC. Pendant structure: Steel.

Light Source and electronics

12 x LED 3,15W 1050 mA
 Constant Current 1050 mA
 100~240V 50/60Hz

Packaging

2 Boxes
 Total Vol. 0,3290 m³
 Gross weight 16,5 Kg Net weight 11,4 Kg

Notes

Built-in.
UNTIL STOCK RUNS OUT

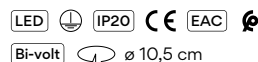

0885

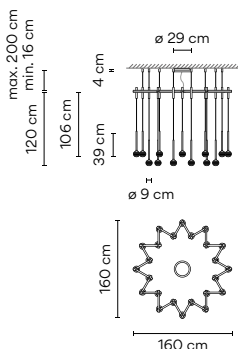

Finishes	LED temperature colour	Control
● 18/ __ Graphite (ADAPTA RF9913WX)	/1_ 2700 K F CRI >90 7494,7 lm 99 lm/W	0885 __ / __ A DALI-2, 1-10V, Push
● 93/ __ White (RAL 9016)	/3_ 3500 K G CRI >90 5425,9 lm 71,8 lm/W	0885 __ / __ Z Casambi

Materials

Ball: Blowed glass. Glass fixation: Aluminum.
 Ceiling rose: Steel. Diffuser: PC. Pendant structure: Steel.

Light Source and electronics

24 x LED 3,15W 1050 mA
 Constant Current 1050 mA
 100~240V 50/60Hz

Packaging

2 Boxes
 Total Vol. 0,7280 m³
 Gross weight 25,25 Kg Net weight 20,25 Kg

Notes

Surface.
UNTIL STOCK RUNS OUT



0887

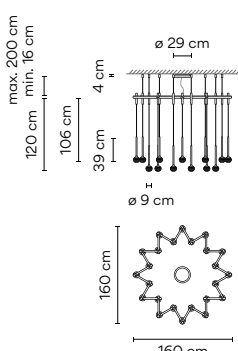

Finishes	LED temperature colour	Control
● 18/ __ Graphite (ADAPTA RF9913WX)	/1_ 2700 K F CRI >90 7494,7 lm 99 lm/W	0887 __ / __ A DALI-2, 1-10V, Push
● 93/ __ White (RAL 9016)	/3_ 3500 K G CRI >90 5425,9 lm 71,8 lm/W	0887 __ / __ Z Casambi

Materials

Ball: Blowed glass. Glass fixation: Aluminum.
 Ceiling rose: Steel. Diffuser: PC. Pendant structure: Steel.

Light Source and electronics

24 x LED 3,15W 1050 mA
 Constant Current 1050 mA
 100~240V 50/60Hz

Packaging

2 Boxes
 Total Vol. 0,7280 m³
 Gross weight 25,25 Kg Net weight 20,25 Kg

Notes

Built-in.
UNTIL STOCK RUNS OUT

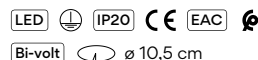

Slim

Design by Jordi Vilardell

Elegant and magical, like drops of light falling from the sky, Slim's long, slender strands are suspended by fibre cords to draw the eye upwards.

Pendants

0916

ø 40 cm



0917

ø 28 cm



0935

ø 69 cm



0937

53 x 26 cm



0920

ø 16 cm ø 16 cm



0925

ø 10 cm



0931

24 x 24 cm



0933

38 x 24 cm



0940

ø 100 cm

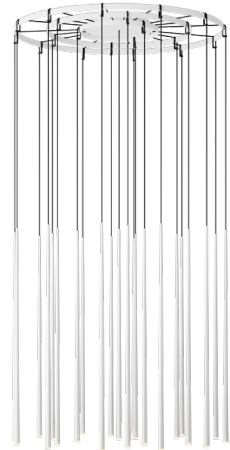



0916

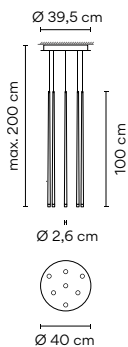

Finishes	LED temperature colour
10/ __ White (NCS S 0300-N)	/1_ 2700 K CRI >90 1268,54 lm 86 lm/W
11/ __ Black (NCS S 8500-N)	/2_ 3000 K CRI >80 1142,4 lm 78 lm/W
24/ __ Beige M1 (NCS S 2005-Y50R)	/3_ 3500 K CRI >90 1453,5 lm 98,9 lm/W
37/ __ Terra Red (NCS S 4040-Y70R)	
47/ __ Green L1 (NCS S 4005-G80Y)	
68/ __ Ocre (NCS S 3050-Y30R)	

Finish customization
(Available options:
Vibia colour palette)

Control

0916 __ / _ 1
DALI

0916 __ / _ B
1-10V, Push

0916 __ / _ Z
Casambi

Materials

Diffuser: Glass. Body: Fiberglass / Carbon fiber.
Canopy Plate: Steel.

Light Source and electronics

7 x LED 2,1 W 700 mA
Constant Current 700 mA
110-240V 50/60Hz

Packaging

1 Box 0,22 x 0,48 x 1,20 m
Vol 0,1278 m³
Gross weight 13 Kg Net weight 9,6 Kg

Notes

Surface

Extra cable length.

UNTIL STOCK RUNS OUT

0917

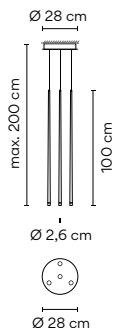

Finishes	LED temperature colour
10/ __ White (NCS S 0300-N)	/1_ 2700 K CRI >90 724,88 lm 86 lm/W
11/ __ Black (NCS S 8500-N)	/2_ 3000 K CRI >80 652,8 lm 78 lm/W
24/ __ Beige M1 (NCS S 2005-Y50R)	/3_ 3500 K CRI >90 830,6 lm 98,9 lm/W
37/ __ Terra Red (NCS S 4040-Y70R)	
47/ __ Green L1 (NCS S 4005-G80Y)	
68/ __ Ocre (NCS S 3050-Y30R)	

Finish customization
(Available options:
Vibia colour palette)

Control

0917 __ / _ 1
DALI

0917 __ / _ B
1-10V, Push

0917 __ / _ Z
Casambi

Materials

Diffuser: Glass. Body: Fiberglass / Carbon fiber.
Canopy Plate: Steel.

Light Source and electronics

4 x LED 2,1 W 700mA
Constant Current 700 mA
110-240V 50/60Hz

Packaging

1 Box 0,22 x 0,48 x 1,20 m
Vol 0,1278 m³
Gross weight 8 Kg Net weight 5,2 Kg

Notes

Surface

Extra cable length.

UNTIL STOCK RUNS OUT

0920

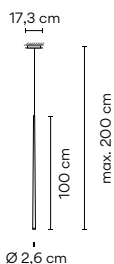

Finishes

- 10/ __ White (NCS S 0300-N)
- 11/ __ Black (NCS S 8500-N)
- 24/ __ Beige M1 (NCS S 2005-Y50R)
- 37/ __ Terra Red (NCS S 4040-Y70R)
- 47/ __ Green L1 (NCS S 4005-G80Y)
- 68/ __ Ocre (NCS S 3050-Y30R)

Finish customization
(Available options:
Vibia colour palette)

LED temperature colour

- /1_ 2700 K F CRI >90 181,22 lm 86 lm/W
- /2_ 3000 K G CRI >80 163,2 lm 78 lm/W
- /3_ 3500 K F CRI >90 207,6 lm 98,9 lm/W

Control

- 0920 __ / __ 0 On/ Off
- 0920 __ / __ 1 DALI
- 0920 __ / __ B 1-10V, Push
- 0920 __ / __ Z Casambi

Materials

Diffuser: Glass. Body: Fiberglass / Carbon fiber.
Canopy Plate: Steel.

Light Source and electronics

1 x LED 2,1 W 700 mA
Constant Current 700 mA
100-240V 50/60Hz

Packaging

1 Box 0,07 x 0,19 x 1,20 m
Vol 0,0155 m³
Gross weight 2,14 Kg Net weight 1,2 Kg

Notes

Surface
Extra cable length.

LED IP20 CE EAC Bi-volt

Electrical connection

- Surface
- _18 Free Wire
- _23 Built-in
- _31 Remote
- Micro for plaster ceilings
- _32 Remote
- XXS for all types of drop ceilings

0925

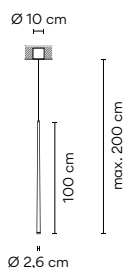

Finishes

- 10/ __ White (NCS S 0300-N)
- 11/ __ Black (NCS S 8500-N)
- 24/ __ Beige M1 (NCS S 2005-Y50R)
- 37/ __ Terra Red (NCS S 4040-Y70R)
- 47/ __ Green L1 (NCS S 4005-G80Y)
- 68/ __ Ocre (NCS S 3050-Y30R)

Finish customization
(Available options:
Vibia colour palette)

LED temperature colour

- /1_ 2700 K F CRI >90 181,22 lm 86 lm/W
- /2_ 3000 K G CRI >80 163,2 lm 78 lm/W
- /3_ 3500 K F CRI >90 207,6 lm 98,9 lm/W

Control

- 0925 __ / __ 0 On/ Off
- 0925 __ / __ 1 DALI
- 0925 __ / __ B 1-10V, Push
- 0925 __ / __ Z Casambi

Materials

Diffuser: Glass. Body: Fiberglass / Carbon fiber.
Canopy Plate: Steel.

Light Source and electronics

1 x LED 2,1 W 700 mA
Constant Current 700 mA
100-240V 50/60Hz

Packaging

1 Box 0,17 x 0,19 x 1,21 m
Vol 0,0370 m³
Gross weight 2,48 Kg Net weight 1,35 Kg

Notes

Built-in
Extra cable length.

UNTIL STOCK RUNS OUT

LED IP20 CE EAC Bi-volt

0931

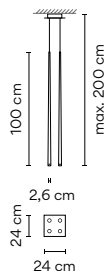

Finishes	LED temperature colour
● 10/ __ White (NCS S 0300-N)	/1 _ 2700 K F → CRI >90 724,88 lm 86 lm/W
● 11/ __ Black (NCS S 8500-N)	/2 _ 3000 K G → CRI >80 652,8 lm 78 lm/W
● 24/ __ Beige M1 (NCS S 2005-Y50R)	/3 _ 3500 K F → CRI >90 830,6 lm 98,9 lm/W
● 37/ __ Terra Red (NCS S 4040-Y70R)	
● 47/ __ Green L1 (NCS S 4005-G80Y)	
● 68/ __ Ocre (NCS S 3050-Y30R)	

Finish customization
(Available options:
Vibia colour palette)

Control

0931 __ / _ 1

DALI

0931 __ / _ B

1-10V, Push

0931 __ / _ Z

Casambi

Materials

Diffuser: Glass. Body: Fiberglass / Carbon fiber.
Canopy Plate: Steel.

Light Source and electronics

4 x LED 2,1 W 700 mA
Constant Current 700 mA
100~240V 50/60Hz

Packaging

1 Box 0,22 x 0,48 x 1,20 m
Vol 0,1267 m³
Gross weight 8 Kg Net weight 5,2 Kg

Notes

Surface

Extra cable length.

UNTIL STOCK RUNS OUT

LED IP20 CE EAC Bi-volt

0933

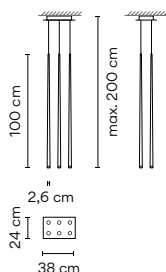

Finishes	LED temperature colour
● 10/ __ White (NCS S 0300-N)	/1 _ 2700 K F → CRI >90 1087,32 lm 86 lm/W
● 11/ __ Black (NCS S 8500-N)	/2 _ 3000 K G → CRI >80 979,2 lm 78 lm/W
● 24/ __ Beige M1 (NCS S 2005-Y50R)	/3 _ 3500 K F → CRI >90 1245,9 lm 98,9 lm/W
● 37/ __ Terra Red (NCS S 4040-Y70R)	
● 47/ __ Green L1 (NCS S 4005-G80Y)	
● 68/ __ Ocre (NCS S 3050-Y30R)	

Finish customization
(Available options:
Vibia colour palette)

Control

0933 __ / _ 1

DALI

0933 __ / _ B

1-10V, Push

0933 __ / _ Z

Casambi

Materials

Diffuser: Glass. Body: Fiberglass / Carbon fiber.
Canopy Plate: Steel.

Light Source and electronics

6 x LED 2,1 W 700 mA
Constant Current 700 mA
110~240V 50/60Hz

Packaging

1 Box 0,22 x 0,48 x 1,20 m
Vol 0,1267 m³
Gross weight 12,5 Kg Net weight 9,1 Kg

Notes

Surface

Extra cable length.

UNTIL STOCK RUNS OUT

LED IP20 CE EAC Bi-volt

0935

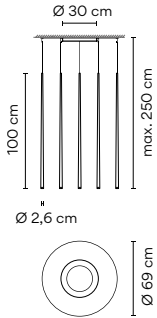

Finishes

- 10/ __ White (NCS S 0300-N)
- 11/ __ Black (NCS S 8500-N)
- 24/ __ Beige M1 (NCS S 2005-Y50R)
- 37/ __ Terra Red (NCS S 4040-Y70R)
- 47/ __ Green L1 (NCS S 4005-G80Y)
- 68/ __ Ocre (NCS S 3050-Y30R)

Finish customization
 (Available options:
 Vibia colour palette)

LED temperature colour

- /1 2700 K CRI >90 954,5 lm 95 lm/W
- /2 3000 K CRI >80 1140 lm 114 lm/W
- /3 3500 K CRI >90 1093,7 lm 109,4 lm/W

Control

- 0935 __ / __ 1 DALI-2
- 0935 __ / __ B 1-10V, Push
- 0935 __ / __ Z Casambi

Materials

Diffuser: Glass. Body: Fiberglass / Carbon fiber.
 Canopy Plate: Steel.

Light Source and electronics

10 x LED 1 W 350 mA
 Constant Current 350 mA
 110-240V 50/60Hz

Packaging

1 Box 1,14 x 1,14 x 0,34 m
 Vol 0,4410 m³
 Gross weight 19,2 Kg Net weight 14,2 Kg

Notes

Surface
 Extra cable length.

UNTIL STOCK RUNS OUT



0937

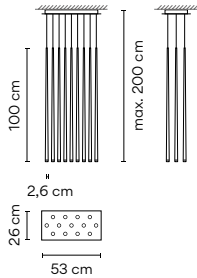

Finishes

- 10/ __ White (NCS S 0300-N)
- 11/ __ Black (NCS S 8500-N)
- 24/ __ Beige M1 (NCS S 2005-Y50R)
- 37/ __ Terra Red (NCS S 4040-Y70R)
- 47/ __ Green L1 (NCS S 4005-G80Y)
- 68/ __ Ocre (NCS S 3050-Y30R)

Finish customization
 (Available options:
 Vibia colour palette)

LED temperature colour

- /1 2700 K CRI >90 2355,86 lm 86 lm/W
- /2 3000 K CRI >80 2121,6 lm 78 lm/W
- /3 3500 K CRI >90 2699,4 lm 98,9 lm/W

Control

- 0937 __ / __ 1 DALI-2
- 0937 __ / __ A DALI, 1-10V, Push
- 0937 __ / __ Z Casambi

Materials

Diffuser: Glass. Body: Fiberglass / Carbon fiber.
 Canopy Plate: Steel.

Light Source and electronics

13 x LED 2,1W 700mA
 Constant Current 700 mA
 110-240V 50/60Hz

Packaging

1 Box 0,22 x 0,48 x 1,20 m
 Vol 0,1267 m³
 Gross weight 12,5 Kg Net weight 18,46 Kg

Notes

Surface
 Extra cable length.

UNTIL STOCK RUNS OUT



0940

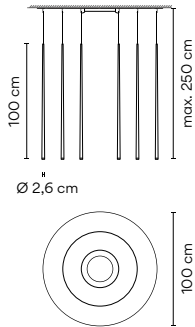

Finishes	
● 10/ __ White (NCS S 0300-N)	
● 11/ __ Black (NCS S 8500-N)	
● 24/ __ Beige M1 (NCS S 2005-Y50R)	
● 37/ __ Terra Red (NCS S 4040-Y70R)	
● 47/ __ Green L1 (NCS S 4005-G80Y)	
● 68/ __ Ocre (NCS S 3050-Y30R)	

Finish customization
(Available options:
Vibia colour palette)

LED temperature colour	
/1 _ 2700 K	CRI >90 2099,9 lm 95 lm/W
/2 _ 3000 K	CRI >80 2508 lm 114 lm/W
/3 _ 3500 K	CRI >90 2406,1 lm 109,4 lm/W

Control	
0940 __ / _ 1	DALI
0940 __ / _ B	1-10V, Push
0940 __ / _ Z	Casambi

Materials

Diffuser: Glass. Body: Fiberglass / Carbon fiber.
Canopy Plate: Steel.

Light Source and electronics

22 x LED 1W 350 mA
Constant Current 350 mA
110-240V 50/60Hz

Packaging

1 Box 1,14 x 1,14 x 0,34 m
Vol 0,4420 m³
Gross weight 29,9 Kg Net weight 21,9 Kg

Notes

Surface

Extra cable length.

UNTIL STOCK RUNS OUT



Composing pendants

Next sketches are composed by one or more compositions

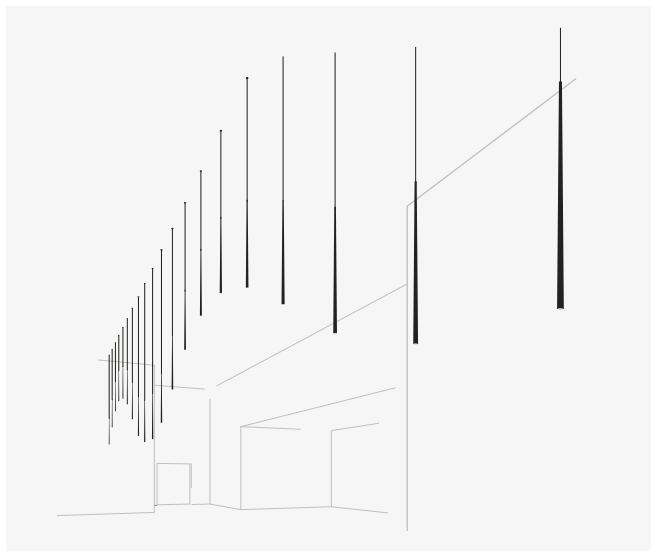

22 x 0920.

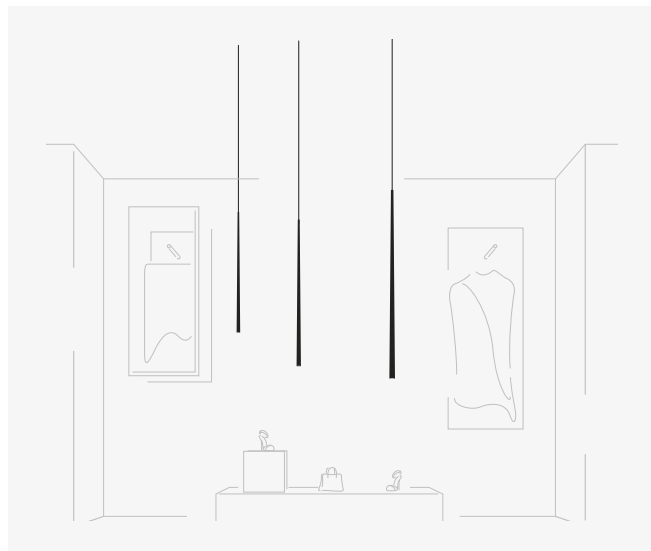

3 x 0920.

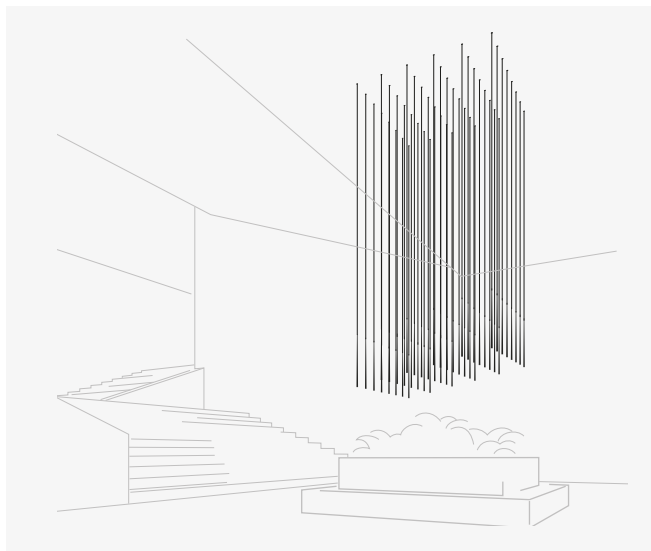

40 x 0920.

Each project is unique.
Visit vibia.com and
choose among multiple
compositions designed
and adapted to your
project needs.

Personalise your own
Slim composition quick
and easy at vibia.com

Electrical connection options for models 0920

Choose your preferred installation option according to your needs. For each composition, the optimal minimum number of drivers will be delivered.

Drop ceiling

The innovative remote and built-in fittings accentuate the silkiness and lightness of compositions on suspended ceilings, its great visual grandeur taking center stage.

For Ref. 0920 __ /10 / 0920 __ /1B

Remote

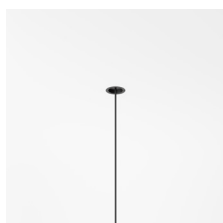

Micro \varnothing 3 cm
height 7 cm
for plaster ceilings.
Black finish.

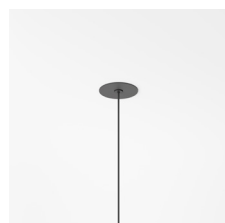
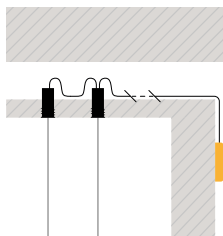

XXS \varnothing 6 cm
height 6 cm
for all types of drop ceilings. Match with fixture finish.



Built-in



\varnothing 8 cm
height 6 cm
match with fixture finish.

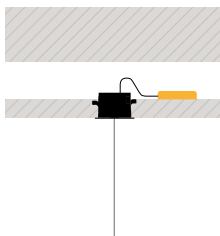

Regular ceiling

When architecture does not allow for performance, surface and free wire showcase possibilities for any need or desire with no limits, ideal for both individual or cluster arrangements.

For Ref. 0920__/10

Surface



ø 17,3 cm
match with
fixture finish.

Free Wire

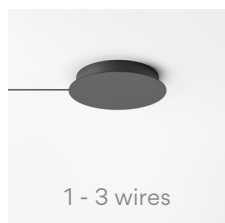

1 - 3 wires

ø 20 cm

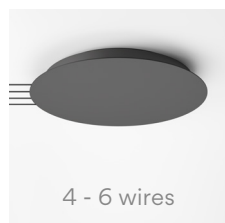

4 - 6 wires

ø 36 cm

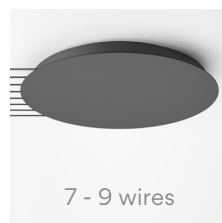

7 - 9 wires

ø 40 cm

For Ref. 0920__/1B / -1 / -Z

Surface



ø 20 cm
match with
fixture finish.

Free Wire

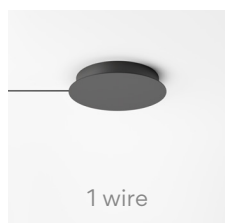

1 wire

ø 20 cm

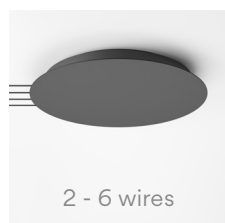

2 - 6 wires

ø 36 cm

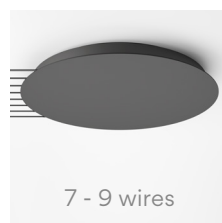

7 - 9 wires

ø 40 cm

you can choose the finish of the canopy
among black, white or any colour
matching one of the pendants.

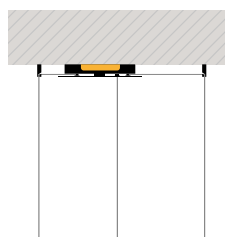
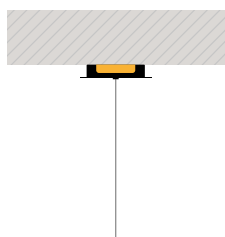

Quadra Ice

Classic and timeless silhouette.
Minimal presence. Integrates readily.

Ceiling

1128 1138



42 cm

1134



66 cm

1128

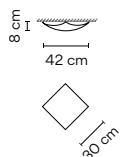

Finishes

- 00 White glass (RAL 9016)

Materials

Ceiling support: Steel. Diffuser: Glass.

Light Source and electronics

1 x R7s 80mm 230V 120 W Eco Max

1128 00

Packaging

1 Box 0,21 x 0,41 x 0,41 m

Vol 0,0353 m³

Gross weight 2,24 Kg Net weight 1,44 Kg

Notes

UNTIL STOCK RUNS OUT



1134

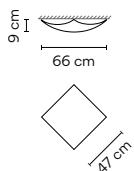

Finishes

- 00 White glass (RAL 9016)

Materials

Ceiling support: Steel. Diffuser: Glass.

Light Source and electronics

1 x R7s 117mm 230V 230 W Eco Max.

1134 00

Packaging

1 Box 0,27 x 0,60 x 0,60 m

Vol 0,0972 m³

Gross weight 6,2 Kg Net weight 4,2 Kg

Notes

UNTIL STOCK RUNS OUT



1138

Finishes **00/ _ _ White glass**
 (RAL 9016)

LED temperature colour **/1_ 2700 K**
 CRI >90 1637,0 lm 99 lm/W

Control **1138 _ _ / _ 1**
 DALI-2

1138 _ _ / _ B
 1-10V, Push

1138 _ _ / _ Z
 Casambi

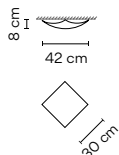

Materials
 Ceiling support: Steel. Diffuser: Glass.

Light Source and electronics
 1 x LED PLATE 16,5 W 500 mA
 Constant Current 500 mA
 110-240V 50/60Hz

Packaging
 1 Box 0,21 x 0,41 x 0,41 m
 Vol 0,0353 m³
 Gross weight 2,24 Kg Net weight 1,65 Kg

Notes
UNTIL STOCK RUNS OUT



Top

Design by Ramos & Bassols

Soft, spherical shapes and a warm luminescence characterize the Top collection. Its glowing epicenter is encircled by a larger ring, lending the look of framing the light within its pure geometry.

Ceiling Wall

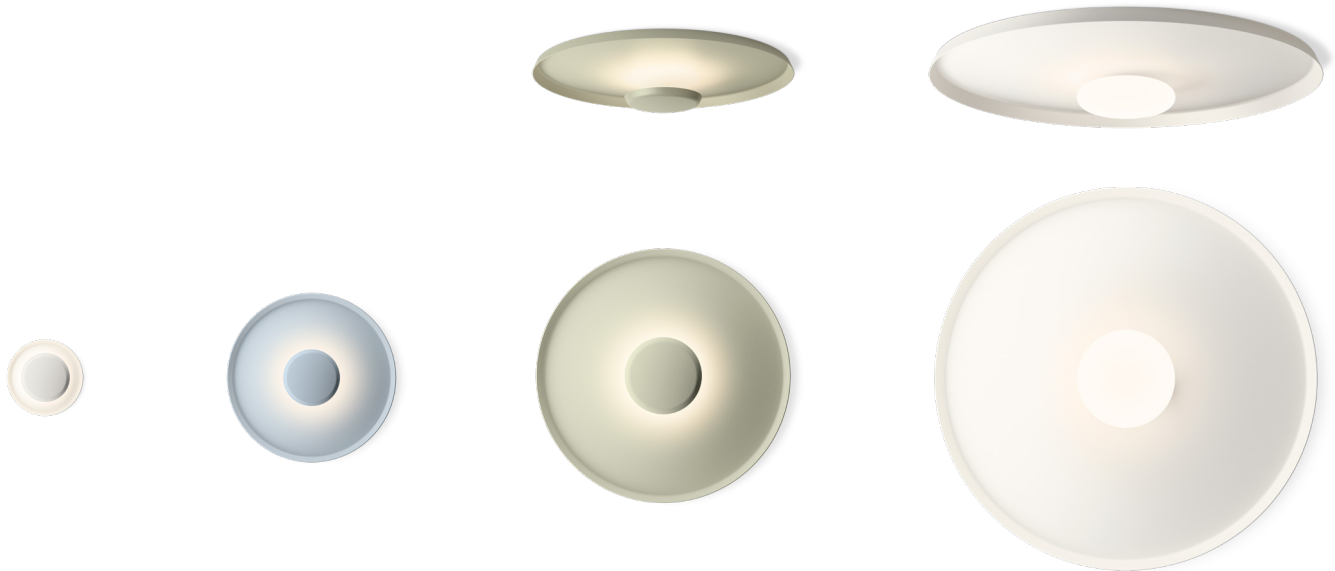

1154

∅ 17 cm

1155

∅ 40 cm

1160

∅ 60 cm

1170

∅ 90 cm

1154

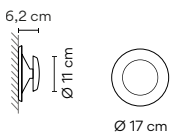

Finishes

- 10/ __ White (NCS S 0300-N)
- 36/ __ Soft pink (NCS S 1010-Y50R)
- 40/ __ Blue L1 (NCS S 3010-B)
- 47/ __ Green L1 (NCS S 4005-G80Y)

ED temperature colour

- /1 _ 2700 K CRI >90 550 lm 100 lm/W
- /3 _ 3500 K CRI >90 540,2 lm 98,2 lm/W

Control

1154 __ / _ 0
On/ Off

Materials

Body: Aluminum.

Light Source and electronics

1 x LED PLATE 5,5 W 150 mA
Constant Current 150 mA
100~240V 50/60Hz

Packaging

1 Box 0,2 x 0,2 x 0,1 m
Vol 0,004 m³
Gross weight 0,8 Kg Net weight 0,5 Kg

1155

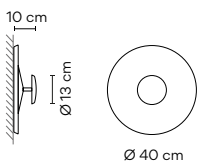

Finishes

- 10/ __ White (NCS S 0300-N)
- 36/ __ Soft pink (NCS S 1010-Y50R)
- 40/ __ Blue L1 (NCS S 3010-B)
- 47/ __ Green L1 (NCS S 4005-G80Y)

ED temperature colour

- /1 _ 2700 K CRI >90 2050 lm 112 lm/W
- /3 _ 3500 K CRI >90 2013,4 lm 110 lm/W

Control

1155 __ / _ 1
DALI-2
1155 __ / _ B
1-10V, Push
1155 __ / _ Z
Casambi

Materials

Body: Aluminum.

Light Source and electronics

1 x LED PLATE 18,3 W 500 mA
Constant Current 500 mA
220~240V 50/60Hz

Packaging

1 Box 0,45 x 0,45 x 0,15 m
Vol 0,03 m³
Gross weight 1,8 Kg Net weight 1,5 Kg



1160

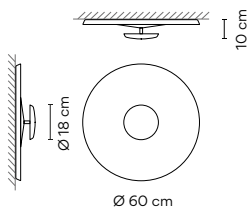

Finishes

- 10/ __ White (NCS S 0300-N)
- 36/ __ Soft pink (NCS S 1010-Y50R)
- 40/ __ Blue L1 (NCS S 3010-B)
- 47/ __ Green L1 (NCS S 4005-G80Y)

LED temperature colour

- /1 _ 2700 K CRI >90 2880 lm 109 lm/W
- /3 _ 3500 K CRI >90 2828,6 lm 107,1 lm/W

Control

- 1160 __ / _ A DALI-2, 1-10V, Push
- 1160 __ / _ Z Casambi

Materials

Body: Aluminum.

Light Source and electronics
 1 x LED PLATE 26,4 W 700 mA
 Constant Current 700 mA
 110-240V 50/60Hz

Packaging

1 Box 0,65 x 0,65 x 0,15 m
 Vol 0,063 m³
 Gross weight 3,13 Kg Net weight 2,5 Kg

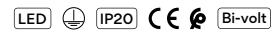

1170

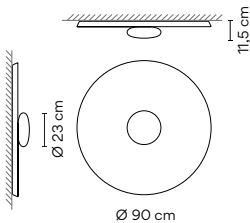

Finishes

- 10/ __ White (NCS S 0300-N)
- 36/ __ Soft pink (NCS S 1010-Y50R)
- 40/ __ Blue L1 (NCS S 3010-B)
- 47/ __ Green L1 (NCS S 4005-G80Y)

LED temperature colour

- /1 _ 2700 K CRI >90 4056,81 lm 101 lm/W
- /3 _ 3500 K CRI >90 4243,6 lm 105,6 lm/W

Control

- 1170 __ / _ A DALI-2, 1-10V, Push
- 1170 __ / _ Z Casambi

Materials

Body: Aluminum. Diffuser: Triplex Opal Glass.

Light Source and electronics
 3 x LED 13,4 W 700 mA
 Constant Current 700 mA
 220-240V 50/60Hz

Packaging

1 Box 1 x 1 x 0,2 m
 Vol 0,02 m³
 Gross weight 7,7 Kg Net weight 5,3 Kg



Jazz

Design by Diego Fortunato

Sculptural design with a marked sensual but strong character.

Ancestral forms converted into modern design icons.

Floor Table

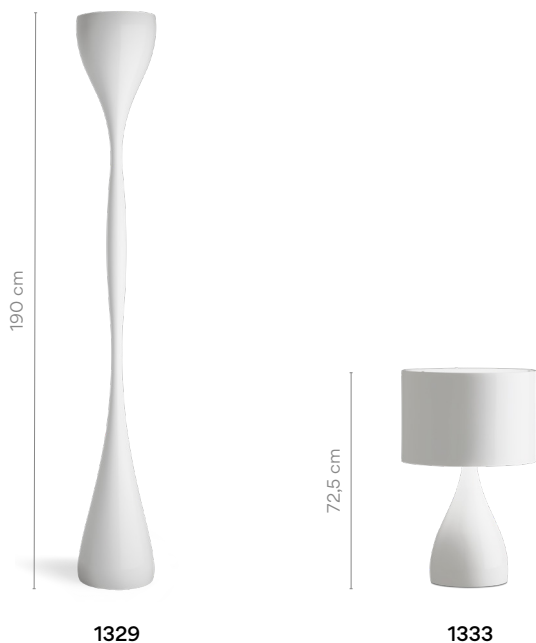

1329

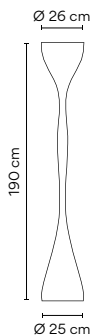

- Finishes**
- 10 White (NCS S 0300-N)
 - 25 Beige D1 (NCS S 4005-Y50R)
 - 45 Blue D1 (NCS S 7010-B10G)

LED temperature colour
/1_ 2700 K
CRI >90 3736 lm 95,8 lm/W

Control
1329 __ / _ 5
Push
1329 __ / _ Z
Casambi

Materials
Body: Polyurethane. Diffuser: Polycarbonate.

Light Source and electronics
1 x LED PLATE 18,3 W 500 mA
Constant Current 1050 mA
100~240Vac 50/60Hz

Packaging
2 Boxes 0,45 x 0,80 x 0,20 m
Total Vol 0,1880 m³
Gross weight 19,8 Kg Net weight 15 Kg

Notes
Dimmer on the cable. Electric cable 2,5 m



1333

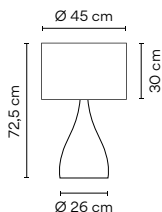

- Finishes**
- 10 White (NCS S 0300-N)
 - 25 Beige D1 (NCS S 4005-Y50R)
 - 45 Blue D1 (NCS S 7010-B10G)

LED 700 K 1520 lm/W

1333 __

Materials
Body: Polyurethane. Diffuser: Optical-glass.
Shade: Aluminum.

Light Source and electronics
4 x LED E27 230V 12 W

Packaging
1 Box 0,51 x 0,51 x 1,14 m
Vol 0,2960 m³
Gross weight 10 Kg Net weight 7,9 Kg

Notes
Switch on the cable. Electric cable 1,5 m.

UNTIL STOCK RUNS OUT





Flamingo

Design by Antoni Arola

Displaying the elegant poise of the bird that inspired it, Flamingo projects a feeling of weightlessness hovering overhead. The deconstructed design separates the LED light source from its translucent shades, producing gradations of diffuse illumination.

Pendants

1510

ø 70 cm



1515

ø 70 cm



1527

ø 90 cm



1530

ø 90 cm



1540

ø 70 cm

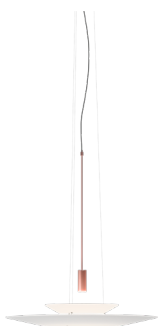

1550

ø 90 cm



1560

ø 90 cm



1570

ø 90 cm



1510

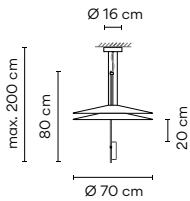

- Finishes**
- 18/ __ Graphite (RAL 7016)
 - 20/ __ Gold (Gold)
 - 67/ __ Copper (Copper)
 - 93/ __ White (RAL 9016)

- LED temperature colour**
- /1 _ 2700 K CRI >90 1108,02 lm 99 lm/W
 - /3 3500 K CRI >90 1278,8 lm 114,2 lm/W

- Control**
- 1510 __ / _ 1 DALI-2
 - 1510 __ / _ B 1-10V, Push
 - 1510 __ / _ Z Casambi

Materials
 Diffuser: Methacrylate. Shade: Acrylic.
 Body: Aluminum. Canopy and rods: Steel.

Light Source and electronics
 2 x LED 5,6 W 500 mA
 Constant Current 500 mA
 110-240V 50/60Hz

Packaging
 2 Boxes
 Total Vol 0,1320 m³
 Gross weight 8,7 Kg Net weight 7,8 Kg

Notes
 Extra cable length.



1515

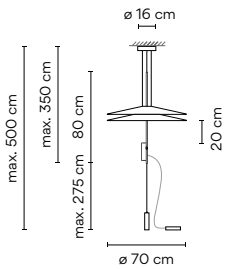

- Finishes**
- 18/ __ Graphite (RAL 7016)
 - 20/ __ Gold (Gold)
 - 67/ __ Copper (Copper)
 - 93/ __ White (RAL 9016)

- LED temperature colour**
- /1 _ 2700 K CRI >90 1108,02 lm 99 lm/W
 - /3 3500 K CRI >90 1278,8 lm 114,2 lm/W

- Control**
- 1515 __ / _ 5 Push

Materials
 Diffuser: Methacrylate. Shade: Acrylic.
 Body: Aluminum. Canopy and rods: Steel.

Light Source and electronics
 2 x LED 5,6 W 500 mA
 Constant Current 500 mA
 110-240V 50/60Hz

Packaging
 2 Boxes
 Total Vol 0,0620 m³
 Gross weight 7,2 Kg Net weight 5,2 Kg

Notes
 Dimmer on the cable. Electric cable 2,5 m
 Extra cable length.

UNTIL STOCK RUNS OUT



1527

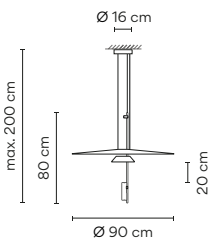

- Finishes**
- 18/ __ Graphite (RAL 7016)
 - 20/ __ Gold (Gold)
 - 67/ __ Copper (Copper)
 - 93/ __ White (RAL 9016)

- LED temperature colour**
- /1 _ 2700 K CRI >90 1108,02 lm 99 lm/W
 - /3 3500 K CRI >90 1278,8 lm 114,2 lm/W

- Control**
- 1527 __ / _ 1 DALI-2
 - 1527 __ / _ B 1-10V, Push
 - 1527 __ / _ Z Casambi

Materials
 Diffuser: Methacrylate. Shade: Acrylic.
 Body: Aluminum. Canopy and rods: Steel.

Light Source and electronics
 2 x LED 5,6 W 500 mA
 Constant Current 500 mA
 110-240V 50/60Hz

Packaging
 1 Box 0,12 x 0,80 x 0,79 m
 Vol 0,0634 m³
 Gross weight 4,1 Kg Net weight 3,69 Kg

Notes
 Extra cable length.



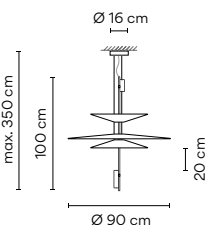

1530



Finishes

- **18/** __ Graphite (RAL 7016)
- **20/** __ Gold (Gold)
- **67/** __ Copper (Copper)
- **93/** __ White (RAL 9016)

LED temperature colour

- /1_ 2700 K  CRI >90 1662,03 lm 99 lm/W
- /3_ 3500 K  CRI >90 1918,2 lm 114,2 lm/W

Control

1530 __ / _ 1
DALI-2

1530 __ / _ B
1-10V, Push

1530 __ / _ Z
Casambi

Materials

Diffuser: Methacrylate. Shade: Acrylic.
Body: Aluminum. Canopy and rods: Steel.

Light Source and electronics





3 x LED 5,6 W 500 mA
Constant Current 500 mA
220-240V 50/60Hz

Packaging

3 Boxes
Total Vol 0,1520 m³
Gross weight 10 Kg Net weight 7 Kg

Notes

Extra cable length.



1540

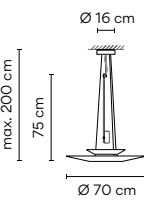

Finishes

- **18/** __ Graphite (RAL 7016)
- **20/** __ Gold (Gold)
- **67/** __ Copper (Copper)
- **93/** __ White (RAL 9016)

LED temperature colour

- /1_ 2700 K  CRI >90 554,01 lm 99 lm/W
- /3_ 3500 K  CRI >90 639,4 lm 114,2 lm/W

Control

1540 __ / _ 1
DALI-2

1540 __ / _ B
1-10V, Push

1540 __ / _ Z
Casambi

Materials

Diffuser: Methacrylate. Shade: Acrylic.
Body: Aluminum. Canopy and rods: Steel.

Light Source and electronics







1 x LED 5,6 W 500 mA
Constant Current 500 mA
110-240V 50/60Hz

Packaging

2 Boxes
Total Vol 0,0620 m³
Gross weight 6 Kg Net weight 4 Kg

Notes

Extra cable length.



1550

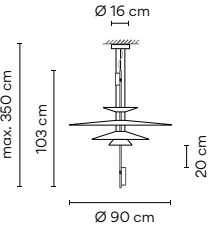

Finishes

- **18/** __ Graphite (RAL 7016)
- **20/** __ Gold (Gold)
- **67/** __ Copper (Copper)
- **93/** __ White (RAL 9016)

LED temperature colour

- /1_ 2700 K  CRI >90 1662,03 lm 99 lm/W
- /3_ 3500 K  CRI >90 1918,2 lm 114,2 lm/W

Control

1550 __ / _ 1
DALI-2

1550 __ / _ B
1-10V, Push

1550 __ / _ Z
Casambi

Materials

Diffuser: Methacrylate. Shade: Acrylic.
Body: Aluminum. Canopy and rods: Steel.

Light Source and electronics





3 x LED 5,6 W 500 mA
Constant Current 500 mA
220-240V 50/60Hz

Packaging

3 Boxes
Total Vol 0,1520 m³
Gross weight 11,3 Kg Net weight 8,8 Kg

Notes

Extra cable length.

1560

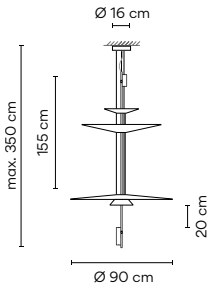

- Finishes**
- 18/ __ Graphite (RAL 7016)
 - 20/ __ Gold (Gold)
 - 67/ __ Copper (Copper)
 - 93/ __ White (RAL 9016)

- LED temperature colour**
- /1 _ 2700 K CRI >90 1662,03 lm 99 lm/W
 - /3 3500 K CRI >90 1918,2 lm 114,2 lm/W

- Control**
- 1560 __ / _ 1 DALI-2
 - 1560 __ / _ B 1-10V, Push
 - 1560 __ / _ Z Casambi

Materials
 Diffuser: Methacrylate. Shade: Acrylic.
 Body: Aluminum. Canopy and rods: Steel.

Light Source and electronics
 3 x LED 5,6 W 500 mA
 Constant Current 500 mA
 220-240V 50/60Hz

Packaging
 3 Boxes
 Total Vol 0,1860 m³
 Gross weight 12,7 Kg Net weight 10,2 Kg

Notes
 Extra cable length.

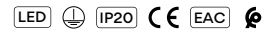

1570

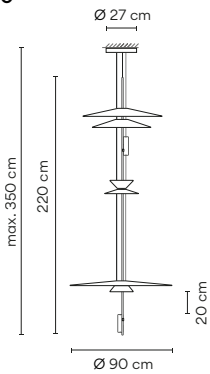

- Finishes**
- 18/ __ Graphite (RAL 7016)
 - 20/ __ Gold (Gold)
 - 67/ __ Copper (Copper)
 - 93/ __ White (RAL 9016)

- LED temperature colour**
- /1 _ 2700 K CRI >90 2216,04 lm 99 lm/W
 - /3 3500 K CRI >90 2557,6 lm 114,2 lm/W

- Control**
- 1570 __ / _ 1 DALI-2
 - 1570 __ / _ B 1-10V, Push
 - 1570 __ / _ Z Casambi

Materials
 Diffuser: Methacrylate. Shade: Acrylic.
 Body: Aluminum. Canopy and rods: Steel.

Light Source and electronics
 4 x LED 5,6 W 500 mA
 Constant Current 500 mA
 110-240V 50/60Hz

Packaging
 2 Boxes
 Total Vol 0,1633 m³
 Gross weight 10 Kg Net weight 8,64 Kg

Notes
 Extra cable length.

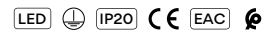

Flamingo Mini

Design by Antoni Arola

Flamingo Mini creates multi-layered silhouettes with an avant-garde, intriguing aesthetic. This hanging lamp recalls a bird hovering overhead, bringing an intimate ambience as it casts diffuse gradations of soothing light through its translucent diffuser.

Pendants

1575

Ø 45 cm

1580

Ø 9 cm

1585

Ø 45 cm

1590

Ø 45 cm

Option A

Option B

Option C



Three options of installation



1575

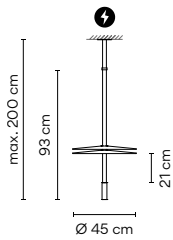

Finishes
 ● 11/ _ _ Black (NCS S 8500-N)

LED Colour Temperature
 /1 _ 2700 K CRI >90 726 lm 124 lm/W

Control
 1575 _ _ / _ 1 DALI-2
 1575 _ _ / _ B Push; 1-10V
 1575 _ _ / _ Z Casambi

Materials
 Diffuser: PMMA. Rods: Stainless steel.
 Body: Aluminum. Canopy: ABS.

Light Source and electronics
 2 x LED 3W 175 mA
 Constant current 350 mA
 110-240Vac 50/60Hz

Packaging
 2 Boxes
 Box 1: 0,07 x 0,07 x 1,25 m
 Box 2: 0,51 x 0,51 x 0,16 m
 Total Vol 0,0478 m³
 Gross weight 5,5 Kg Net weight 4 Kg

Notes
 Additional cable length personalisation

LED IP20 CE EAC Bi-volt

Select Electrical connection Surface _23 Built-in XS

1580

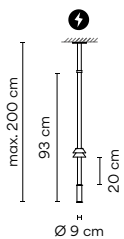

Finishes
 ● 11/ _ _ Black (NCS S 8500-N)

LED Colour Temperature
 /1 _ 2700 K CRI >90 726 lm 124 lm/W

Control
 1580 _ _ / _ 1 DALI-2
 1580 _ _ / _ B Push; 1-10V
 1580 _ _ / _ Z Casambi

Materials
 Diffuser: PMMA. Rods: Stainless steel.
 Body: Aluminum. Canopy: ABS.

Light Source and electronics
 2 x LED 3W 175 mA
 Constant current 350 mA
 110-240Vac 50/60Hz

Packaging
 2 Boxes
 Box 1: 0,068 x 0,068 x 1,25 m
 Box 2: 0,20 x 0,21 x 0,13 m
 Total Vol 0,0112 m³
 Gross weight 4 Kg Net weight 3 Kg

Notes
 Additional cable length personalisation

LED IP20 CE EAC Bi-volt

Select Electrical connection Surface _23 Built-in XS

1585

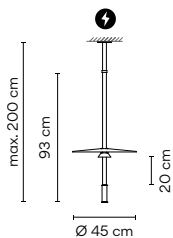

Finishes
 ● 11/ _ _ Black (NCS S 8500-N)

LED Colour Temperature
 /1 _ 2700 K CRI >90 726 lm 124 lm/W

Control
 1585 _ _ / _ 1 DALI-2
 1585 _ _ / _ B Push; 1-10V
 1585 _ _ / _ Z Casambi

Materials
 Diffuser: PMMA. Rods: Stainless steel.
 Body: Aluminum. Canopy: ABS.

Light Source and electronics
 2 x LED 3W 175 mA
 Constant current 350 mA
 110-240Vac 50/60Hz

Packaging
 2 Boxes
 Box 1: 0,07 x 0,07 x 1,25 m
 Box 2: 0,51 x 0,51 x 0,16 m
 Total Vol 0,0478 m³
 Gross weight 5,5 Kg Net weight 4 Kg

Notes
 Additional cable length personalisation

LED IP20 CE EAC Bi-volt

Select Electrical connection Surface _23 Built-in XS

1590

Finishes
 ● 11/ _ _ Black
 (NCS S 8500-N)

LED Colour Temperature
 /1 _ 2700 K 
 CRI>90 1152 lm 132 lm/W

Control
 1590 _ _ / _ 1
 DALI-2

 Select
 Eletrical
 connection
 Surface
 _23 Built-in XS

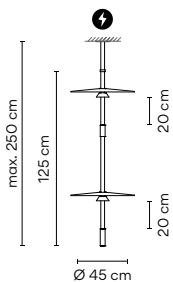

Materials
 Diffuser: PMMA. Rods: Stainless steel.
 Body: Aluminum. Canopy: ABS.

Light Source and electronics
 3 x LED COB 3W 185 mA
 Constant Current 550 mA
 110~240Vac 50/60Hz

Packaging
 2 Boxes
 Box 1: 0,07 x 0,07 x 1,60 m
 Box 2: 0,51 x 0,51 x 0,16 m
 Total Vol 0,0494 m³
 Gross weight 6,5 Kg Net weight 5 Kg

Notes
 Additional cable length
 personalisation

Electrical connection options

Choose your preferred installation option according to your needs.

Drop ceiling

Regular ceiling

_23 Built-in XS



Ø 8 cm
 height 6 cm
 black finish.

Surface



Ø 10 cm
 black finish.



Pin

Design by Ichiro Iwasaki

Through the exploration of “eternal comfort” in lighting environments PIN aims to provide something new and original yet in harmony with both the old and the contemporary.

Table



1650

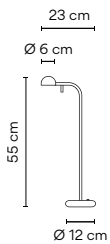

Finishes

- **04/** __ Black (NCS 9000N)
- **58/** __ Cream (NCS S 2005-Y20R)
- **62/** __ Green (NCS S 3010-G20Y)
- **93/** __ White (NCS S 0502-Y)

Finish customization
(Available options: Vibia colour palette)

LED temperature colour
/1_ 2700 K
CRI >90 485 lm 121 lm/W

Control
1650 __ / __ 0
On/ Off

Materials
Head: Aluminum. Base: Zamak.
Diffuser: Polycarbonate. Rod: Steel.

Light Source and electronics
1 x LED 4,5 W 350 mA
Constant Current 350 mA
100~240V 50/60Hz

Packaging
1 Box 0,174 x 0,212 x 0,713 m
Vol 0,0212 m³
Gross weight 2,94 Kg Net weight 2 Kg

Notes
Switch on the base. Electric cable 3 m.

1655

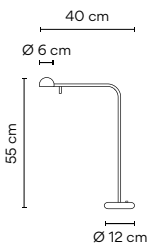

Finishes

- **04/** __ Black (NCS 9000N)
- **58/** __ Cream (NCS S 2005-Y20R)
- **62/** __ Green (NCS S 3010-G20Y)
- **93/** __ White (NCS S 0502-Y)

Finish customization
(Available options: Vibia colour palette)

LED temperature colour
/1_ 2700 K
CRI >90 485 lm 121 lm/W

Control
1655 __ / __ 0
On/ Off

Materials
Head: Aluminum. Base: Zamak.
Diffuser: Polycarbonate. Rod: Steel.

Light Source and electronics
1 x LED 4,5 W 350 mA
Constant Current 350 mA
100~240V 50/60Hz

Packaging
1 Box 0,20 x 0,357 x 0,67 m
Vol 0,0480 m³
Gross weight 3,68 Kg Net weight 2,2 Kg

Notes
Switch on the base. Electric cable 3 m.

1160 10 /1A
Model Finish
LED temperature colour
Control



Floor



1660

1665

1670

1660

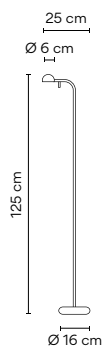

- Finishes**
- **04/** __ Black (NCS 9000N)
 - **58/** __ Cream (NCS S 2005-Y20R)
 - **62/** __ Green (NCS S 3010-G20Y)
 - **93/** __ White (NCS S 0502-Y)

Finish customization
(Available options:
Vibia colour palette)

Materials
Head: Aluminum. Base: Zamak.
Diffuser: Polycarbonate. Rod: Steel.

Light Source and electronics
1 x LED 4,5 W 350 mA
Constant Current 350 mA
100~240V 50/60Hz

LED temperature colour
/1 _ 2700 K
CRI >90 485 lm 121 lm/W

Control
1660 __ / __ 0
On/ Off

Packaging
1 Box 0,149 x 0,265 x 0,33 m
Vol 0,1310 m³
Gross weight 7,45 Kg Net weight 3,8 Kg

Notes
Switch on the base. Electric cable 3 m.





1665

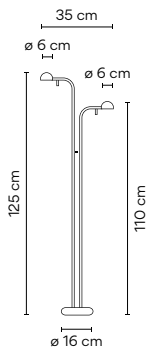

Finishes

- 04/ __ Black (NCS 9000N)
- 58/ __ Cream (NCS S 2005-Y20R)
- 62/ __ Green (NCS S 3010-G20Y)
- 93/ __ White (NCS S 0502-Y)

Finish customization
 (Available options:
 Vibia colour palette)

Materials

Head: Aluminum. Base: Zamak.
 Diffuser: Polycarbonate. Rod: Steel.

Light Source and electronics

2 x LED 4,5 W 350 mA
 Constant Current 350 mA
 100~240V 50/60Hz

LED colour temperature

/1_ 2700 K CRI >90 980,5 lm 109 lm/W

Control

1665 __ / _ 0
 On/ Off

Packaging

1 Box 1,496 x 0,265 x 0,33 m
 Vol 0,1310 m³
 Gross weight 8,25 Kg Net weight 4,6 Kg

Notes

Switch on the base. Electric cable 3 m.

UNTIL STOCK RUNS OUT

1670

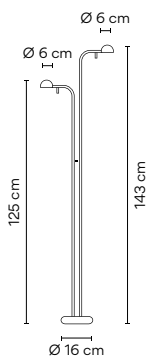

Finishes

- 04/ __ Black (NCS 9000N)
- 58/ __ Cream (NCS S 2005-Y20R)
- 62/ __ Green (NCS S 3010-G20Y)
- 93/ __ White (NCS S 0502-Y)

Finish customization
 (Available options:
 Vibia colour palette)

Materials

Head: Aluminum. Base: Zamak.
 Diffuser: Polycarbonate. Rod: Steel.

Light Source and electronics

2 x LED 4,5 W 350 mA
 Constant Current 350 mA
 100~240V 50/60Hz

LED temperature colour

/1_ 2700 K CRI >90 970 lm 121 lm/W

Control

1670 __ / _ 0
 On/ Off

Packaging

1 Box 1,496 x 0,265 x 0,33 m
 Vol 0,1310 m³
 Gross weight 8,25 Kg Net weight 4,6 Kg

Notes

Switch on the base. Electric cable 3 m.

Wall



ø 10 cm

1675 62



ø 10 cm

1675 04



ø 10 cm

1675 58



ø 10 cm

1675 93



40 cm

ø 10 cm

1680



70 cm

ø 10 cm

1685



70 cm

ø 10 cm

1686



40 cm

ø 10 cm

1690



70 cm

ø 10 cm

1692

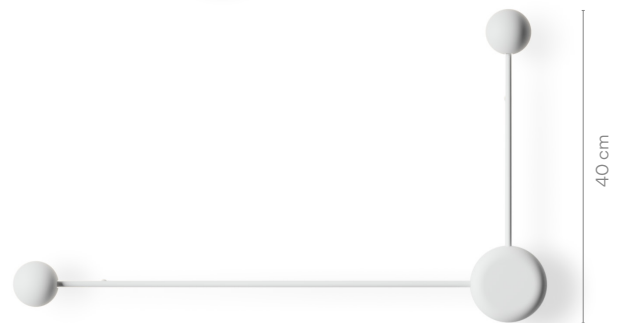

40 cm

70 cm

1694

1675

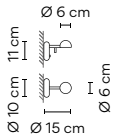

- Finishes**
- 04/ __ Black (NCS 9000N)
 - 58/ __ Cream (NCS S 2005-Y20R)
 - 62/ __ Green (NCS S 3010-G20Y)
 - 93/ __ White (NCS S 0502-Y)

Finish customization
 (Available options:
 Vibia colour palette)

Materials

Head: Aluminum. Base: Zamak.
 Diffuser: Polycarbonate. Rod: Steel.

Light Source and electronics

1 x LED 4,5 W 350 mA
 Constant Current 350 mA
 100~240V 50/60Hz

LED temperature colour
 /1_ 2700 K
 CRI >90 485 lm 121 lm/W

Control
 1675 __ / _ 0
 On/ Off

Packaging

1 Box 0,193 x 0,148 x 0,161 m
 Vol 0,0046 m³
 Gross weight 0,85 Kg Net weight 0,6 Kg

Notes

Switch on the wall plate



1680

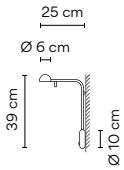

- Finishes**
- 04/ __ Black (NCS 9000N)
 - 58/ __ Cream (NCS S 2005-Y20R)
 - 62/ __ Green (NCS S 3010-G20Y)
 - 93/ __ White (NCS S 0502-Y)

Finish customization
 (Available options:
 Vibia colour palette)

Materials

Head: Aluminum. Base: Zamak.
 Diffuser: Polycarbonate. Rod: Steel.

Light Source and electronics

1 x LED 4,5 W 350 mA
 Constant Current 350 mA
 100~240V 50/60Hz

LED temperature colour
 /1_ 2700 K
 CRI >90 485 lm 121 lm/W

Control
 1680 __ / _ 0
 On/ Off

Packaging

1 Box 0,146 x 0,355 x 0,473 m
 Vol 0,0250 m³
 Gross weight 1,745 Kg Net weight 1 Kg

Notes

Switch on the wall plate



1685

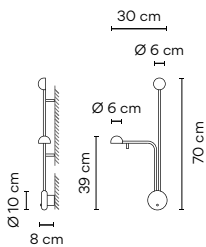

- Finishes**
- 04/ __ Black (NCS 9000N)
 - 58/ __ Cream (NCS S 2005-Y20R)
 - 62/ __ Green (NCS S 3010-G20Y)
 - 93/ __ White (NCS S 0502-Y)

Finish customization
 (Available options:
 Vibia colour palette)

Materials

Head: Aluminum. Base: Zamak.
 Diffuser: Polycarbonate. Rod: Steel.

Light Source and electronics

2 x LED 4,5 W 350 mA
 Constant Current 350 mA
 100~240V 50/60Hz

LED temperature colour
 /1_ 2700 K
 CRI >90 970 lm 121 lm/W

Control
 1685 __ / _ 0
 On/ Off

Packaging

1 Box 0,177 x 0,445 x 0,792 m
 Vol 0,0620 m³
 Gross weight 2,64 Kg Net weight 1,2 Kg

Notes

Switch on the wall plate



1686

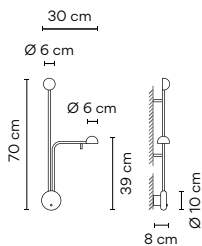

<p>Finishes</p> <ul style="list-style-type: none"> ● 04/ __ Black (NCS 9000N) ● 58/ __ Cream (NCS S 2005-Y20R) ● 62/ __ Green (NCS S 3010-G20Y) ● 93/ __ White (NCS S 0502-Y) <p>Finish customization (Available options: Vibia colour palette)</p>	<p>LED temperature colour</p> <p>/1 2700 K CRI >90 970 lm 121 lm/W</p>	<p>Control</p> <p>1686 __ / __ 0 On/ Off</p>
<p>Materials</p> <p>Head: Aluminum. Base: Zamak. Diffuser: Polycarbonate. Rod: Steel.</p> <p>Light Source and electronics</p> <p>2 x LED 4,5 W 350 mA Constant Current 350 mA 100~240V 50/60Hz</p>	<p>Packaging</p> <p>1 Box 0,177 x 0,445 x 0,792 m Vol 0,0620 m³ Gross weight 2,64 Kg Net weight 1,2 Kg</p> <p>Notes</p> <p>Switch on the wall plate</p>	
<p> </p>		

1690

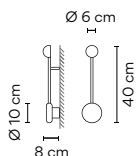

<p>Finishes</p> <ul style="list-style-type: none"> ● 04/ __ Black (NCS 9000N) ● 58/ __ Cream (NCS S 2005-Y20R) ● 62/ __ Green (NCS S 3010-G20Y) ● 93/ __ White (NCS S 0502-Y) <p>Finish customization (Available options: Vibia colour palette)</p>	<p>LED temperature colour</p> <p>/1 2700 K CRI >90 485 lm 121 lm/W</p>	<p>Control</p> <p>1690 __ / __ 0 On/ Off</p>
<p>Materials</p> <p>Head: Aluminum. Base: Zamak. Diffuser: Polycarbonate. Rod: Steel.</p> <p>Light Source and electronics</p> <p>1 x LED 4,5 W 350 mA Constant Current 350 mA 100~240V 50/60Hz</p>	<p>Packaging</p> <p>1 Box 0,146 x 0,355 x 0,473 m Vol 0,0250 m³ Gross weight 1,545 Kg Net weight 0,8 Kg</p>	
<p> </p>		

1692

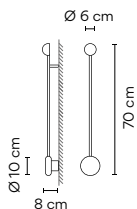

<p>Finishes</p> <ul style="list-style-type: none"> ● 04/ __ Black (NCS 9000N) ● 58/ __ Cream (NCS S 2005-Y20R) ● 62/ __ Green (NCS S 3010-G20Y) ● 93/ __ White (NCS S 0502-Y) <p>Finish customization (Available options: Vibia colour palette)</p>	<p>LED temperature colour</p> <p>/1 2700 K CRI >90 485 lm 121 lm/W</p>	<p>Control</p> <p>1692 __ / __ 0 On/ Off</p>
<p>Materials</p> <p>Head: Aluminum. Base: Zamak. Diffuser: Polycarbonate. Rod: Steel.</p> <p>Light Source and electronics</p> <p>1 x LED 4,5 W 350 mA Constant Current 350 mA 100~240V 50/60Hz</p>	<p>Packaging</p> <p>1 Box 0,177 x 0,445 x 0,792 m Vol 0,620 m³ Gross weight 2,44 Kg Net weight 1 Kg</p>	
<p> </p>		



1694

Finishes

- 04/ __ Black (NCS 9000N)
- 58/ __ Cream (NCS S 2005-Y20R)
- 62/ __ Green (NCS S 3010-G20Y)
- 93/ __ White (NCS S 0502-Y)

Finish customization
 (Available options:
 Vibia colour palette)

LED temperature colour

/1_ 2700 K CRI >90 970 lm 121 lm/W

Control

1694 __ / _ 0
 On/ Off

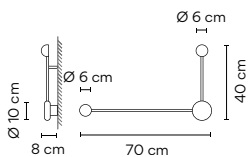

Materials

Head: Aluminum. Base: Zamak.
 Diffuser: Polycarbonate. Rod: Steel.

Light Source and electronics

2 x LED 4,5 W 350 mA
 Constant Current 350 mA
 100~240V 50/60Hz

Packaging

1 Box 0,177 x 0,445 x 0,792 m
 Vol 0,620 m³
 Gross weight 2,84 Kg Net weight 1,4 Kg

Array

Design by Umut Yamac

A striking pendant of impressive proportions, Array is an exploration of thread and its potential to create lightweight and dynamic sculptures of light.

Pendants

Height 70 cm



Ø 37 cm

1800



Ø 55 cm

1815

Height 110 cm

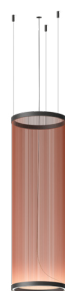

Ø 37 cm

1805

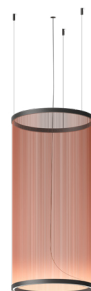

Ø 55 cm

1820

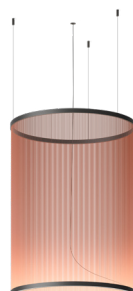

Ø 83 cm

1830

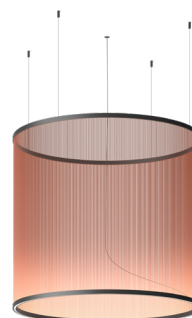

Ø 124 cm

1840

Height 190 cm



Ø 37 cm

1810



Ø 55 cm

1825



Ø 83 cm

1835



Ø 124 cm

1845

Height 70 cm



Ø 55 cm

1850

Height 110 cm



Ø 55 cm

1855



Ø 83 cm

1865



Ø 124 cm

1875

Height 190 cm



Ø 55 cm

1860



Ø 83 cm

1870



Ø 124 cm

1880

1800

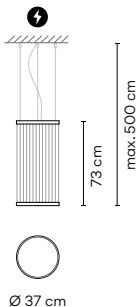

Finishes (threads)	LED Colour Temperature	Control	
● 24/ _ _ Beige M1 (NCS S 2005-Y50R)	/1_ 2700 K CRI >90 2662 lm 121 lm/W	1800 _ _ / _ 3 1-10V	2.180,00 €
● 37/ _ _ Terra Red (NCS S4040-Y70R)		1800 _ _ / _ D Push; DALI-2	2.290,00 €
● 47/ _ _ Green L1 (NCS S 4005-G80Y)		1800 _ _ / _ Z Casambi	2.300,00 €

Finishes (rings and canopy)
● Black (NCS S 8500-N)

Materials
Upper ring: Aluminum. Bottom ring: Brass.
Diffuser: PC- Polycarbonate. Threads: PES FR.

Light Source and electronics
1 x LED STRIP 22W 48V
Constant Voltage 48V
90-305Vac 50/60Hz

Packaging
1 Box 0,62 x 0,62 x 0,12 m
Vol 0,0461 m³
Gross weight 7 Kg Net weight 4,8 Kg

Notes
Extra cable length.



Select Electrical connection
_24 Surface
_31 Built-in S
_31 Remote Micro

1805

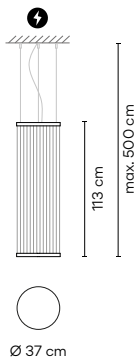

Finishes (threads)	LED Colour Temperature	Control	
● 24/ _ _ Beige M1 (NCS S 2005-Y50R)	/1_ 2700 K CRI >90 2662 lm 121 lm/W	1805 _ _ / _ 3 1-10V	2.290,00 €
● 37/ _ _ Terra Red (NCS S4040-Y70R)		1805 _ _ / _ D Push; DALI-2	2.405,00 €
● 47/ _ _ Green L1 (NCS S 4005-G80Y)		1805 _ _ / _ Z Casambi	2.410,00 €

Finishes (rings and canopy)
● Black (NCS S 8500-N)

Materials
Upper ring: Aluminum. Bottom ring: Brass.
Diffuser: PC- Polycarbonate. Threads: PES FR.

Light Source and electronics
1 x LED STRIP 22W 48V
Constant Voltage 48V
90-305Vac 50/60Hz

Packaging
1 Box 0,62 x 0,62 x 0,12 m
Vol 0,0461 m³
Gross weight 7,3 Kg Net weight 5,1 Kg

Notes
Extra cable length.



Select Electrical connection
_24 Surface
_31 Built-in S
_31 Remote Micro

1810

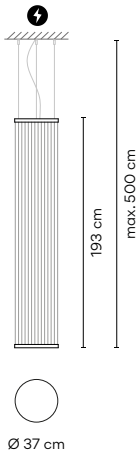

Finishes (threads)	LED Colour Temperature	Control	
● 24/ _ _ Beige M1 (NCS S 2005-Y50R)	/1_ 2700 K CRI >90 2662 lm 121 lm/W	1810 _ _ / _ 3 1-10V	2.340,00 €
● 37/ _ _ Terra Red (NCS S4040-Y70R)		1810 _ _ / _ D Push; DALI-2	2.460,00 €
● 47/ _ _ Green L1 (NCS S 4005-G80Y)		1810 _ _ / _ Z Casambi	2.460,00 €

Finishes (rings and canopy)
● Black (NCS S 8500-N)

Materials
Upper ring: Aluminum. Bottom ring: Brass.
Diffuser: PC- Polycarbonate. Threads: PES FR.

Light Source and electronics
1 x LED STRIP 22W 48V
Constant Voltage 48V
90-305Vac 50/60Hz

Packaging
1 Box 0,62 x 0,62 x 0,12 m
Vol 0,0461 m³
Gross weight 7,6 Kg Net weight 5,4 Kg

Notes
Extra cable length.



Select Electrical connection
_24 Surface
_31 Built-in S
_31 Remote Micro

1815

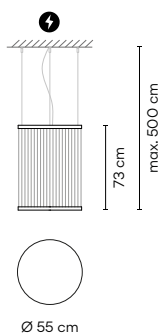

Finishes (threads)	LED Colour Temperature
● 24/ _ _ Beige M1 (NCS S 2005-Y50R)	/1_ 2700 K CRI >90 3993 lm 121 lm/W
● 37/ _ _ Terra Red (NCS S4040-Y70R)	
● 47/ _ _ Green L1 (NCS S 4005-G80Y)	

Control	
1815 _ _ / _ 3 1-10V	2.560,00 €
1815 _ _ / _ D Push; DALI-2	2.690,00 €
1815 _ _ / _ Z Casambi	2.680,00 €

Finishes (rings and canopy)
● Black (NCS S 8500-N)

Materials
Upper ring: Aluminum. Bottom ring: Brass.
Diffuser: PC- Polycarbonate. Threads: PES FR.

Light Source and electronics
1 x LED STRIP 33W 48V
Constant Voltage 48V
90~305Vac 50/60Hz

Packaging
1 Box 0,62 x 0,62 x 0,12 m
Vol 0,0461 m³
Gross weight 8,4 Kg Net weight 6,2 Kg

Notes
Extra cable length.



Select Electrical connection
Surface
_24 Built-in S
_31 Remote Micro

1820

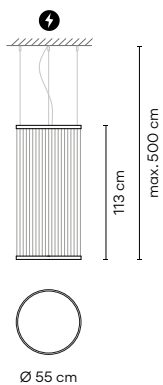

Finishes (threads)	LED Colour Temperature
● 24/ _ _ Beige M1 (NCS S 2005-Y50R)	/1_ 2700 K CRI >90 3993 lm 121 lm/W
● 37/ _ _ Terra Red (NCS S4040-Y70R)	
● 47/ _ _ Green L1 (NCS S 4005-G80Y)	

Control	
1820 _ _ / _ 3 1-10V	2.755,00 €
1820 _ _ / _ D Push; DALI-2	2.895,00 €
1820 _ _ / _ Z Casambi	2.875,00 €

Finishes (rings and canopy)
● Black (NCS S 8500-N)

Materials
Upper ring: Aluminum. Bottom ring: Brass.
Diffuser: PC- Polycarbonate. Threads: PES FR.

Light Source and electronics
1 x LED STRIP 33W 48V
Constant Voltage 48V
90~305Vac 50/60Hz

Packaging
1 Box 0,62 x 0,62 x 0,12 m
Vol 0,0461 m³
Gross weight 8,8 Kg Net weight 6,6 Kg

Notes
Extra cable length.



Select Electrical connection
Surface
_24 Built-in S
_31 Remote Micro

1825

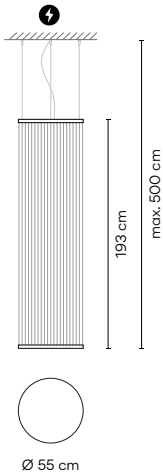

Finishes (threads)	LED Colour Temperature
● 24/ _ _ Beige M1 (NCS S 2005-Y50R)	/1_ 2700 K CRI >90 3993 lm 121 lm/W
● 37/ _ _ Terra Red (NCS S4040-Y70R)	
● 47/ _ _ Green L1 (NCS S 4005-G80Y)	

Control	
1825 _ _ / _ 3 1-10V	2.825,00 €
1825 _ _ / _ D Push; DALI-2	2.970,00 €
1825 _ _ / _ Z Casambi	2.945,00 €

Finishes (rings and canopy)
● Black (NCS S 8500-N)

Materials
Upper ring: Aluminum. Bottom ring: Brass.
Diffuser: PC- Polycarbonate. Threads: PES FR.

Light Source and electronics
1 x LED STRIP 33W 48V
Constant Voltage 48V
90~305Vac 50/60Hz

Packaging
1 Box 0,62 x 0,62 x 0,12 m
Vol 0,0461 m³
Gross weight 9,2 Kg Net weight 7 Kg

Notes
Extra cable length.



Select Electrical connection
Surface
_24 Built-in S
_31 Remote Micro

1830

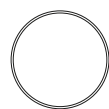
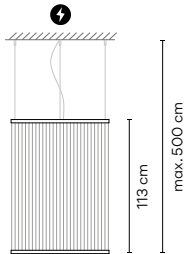

Ø 83 cm

Finishes (threads)
 ● 24/ __ Beige M1 (NCS S 2005-Y50R)
 ● 37/ __ Terra Red (NCS S4040-Y70R)
 ● 47/ __ Green L1 (NCS S 4005-G80Y)

LED Colour Temperature
 /1_ 2700 K CRI >90 6050 lm 121 lm/W

Control
 1830 __ / _ 3
 1-10V

1830 __ / _ D
 Push; DALI-2

1830 __ / _ Z
 Casambi

Finishes (rings and canopy)
 ● Black (NCS S 8500-N)

Materials
 Upper ring: Aluminum. Bottom ring: Brass.
 Diffuser: PC- Polycarbonate. Threads: PES FR.

Light Source and electronics
 1 x LED STRIP 50W 48V
 Constant Voltage 48V
 90~305Vac 50/60Hz

Packaging
 1 Box 0,93 x 0,93 x 0,120 m
 Vol 0,1037 m³
 Gross weight 13,5 Kg Net weight 9,5 Kg

Notes
 Extra cable length.

Select Electrical connection
 Surface
 _24 Built-in S
 _31 Remote Micro

1835

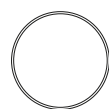
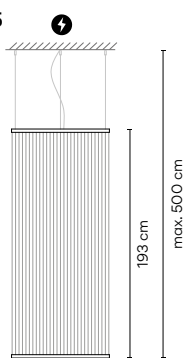

Ø 83 cm

Finishes (threads)
 ● 24/ __ Beige M1 (NCS S 2005-Y50R)
 ● 37/ __ Terra Red (NCS S4040-Y70R)
 ● 47/ __ Green L1 (NCS S 4005-G80Y)

LED Colour Temperature
 /1_ 2700 K CRI >90 6050 lm 121 lm/W

Control
 1835 __ / _ 3
 1-10V

1835 __ / _ D
 Push; DALI-2

1835 __ / _ Z
 Casambi

Finishes (rings and canopy)
 ● Black (NCS S 8500-N)

Materials
 Upper ring: Aluminum. Bottom ring: Brass.
 Diffuser: PC- Polycarbonate. Threads: PES FR.

Light Source and electronics
 1 x LED STRIP 50W 48V
 Constant Voltage 48V
 90~305Vac 50/60Hz

Packaging
 1 Box 0,93 x 0,93 x 0,120 m
 Vol 0,1037 m³
 Gross weight 14,1 Kg Net weight 10,1 Kg

Notes
 Extra cable length.

Select Electrical connection
 Surface
 _24 Built-in S
 _31 Remote Micro

1840

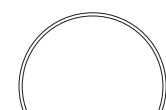
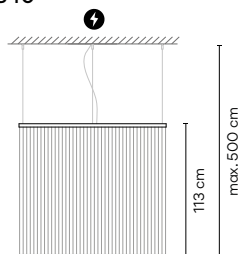

Ø 124 cm

Finishes (threads)
 ● 24/ __ Beige M1 (NCS S 2005-Y50R)
 ● 37/ __ Terra Red (NCS S4040-Y70R)
 ● 47/ __ Green L1 (NCS S 4005-G80Y)

LED Colour Temperature
 /1_ 2700 K CRI >90 9196 lm 121 lm/W

Control
 1840 __ / _ 3
 1-10V

1840 __ / _ D
 Push; DALI-2

1840 __ / _ Z
 Casambi

Finishes (rings and canopy)
 ● Black (NCS S 8500-N)

Materials
 Upper ring: Aluminum. Bottom ring: Brass.
 Diffuser: PC- Polycarbonate. Threads: PES FR.

Light Source and electronics
 1 x LED STRIP 76W 48V
 Constant Voltage 48V
 90~305Vac 50/60Hz

Packaging
 1 Box 1,35 x 1,35 x 0,120 m
 Vol 0,2187 m³
 Gross weight 19 Kg Net weight 13 Kg

Notes
 Extra cable length.

Select Electrical connection
 Surface
 _24 Built-in S
 _31 Remote Micro

1160 | 10 | /1A | 18

Model | Finish | LED Colour Temperature | Control | Electrical connection

1845

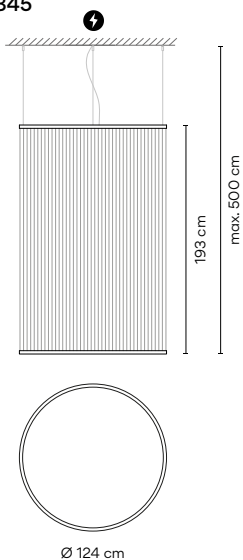

- Finishes (threads)**
- 24/ _ _ Beige M1 (NCS S 2005-Y50R)
 - 37/ _ _ Terra Red (NCS S4040-Y70R)
 - 47/ _ _ Green L1 (NCS S 4005-G80Y)
- LED Colour Temperature**
- /1_ 2700 K CRI >90 9196 lm 121 lm/W

- Control**
- | | |
|----------------|--------------|
| 1845 _ _ / _ 3 | 1-10V |
| 1845 _ _ / _ D | Push; DALI-2 |
| 1845 _ _ / _ Z | Casambi |

Select Electrical connection

Surface
_24 Built-in S
_31 Remote
Micro

- Finishes (rings and canopy)**
- Black (NCS S 8500-N)

Materials

Upper ring: Aluminum. Bottom ring: Brass.
Diffuser: PC- Polycarbonate. Threads: PES FR.

Light Source and electronics

1 x LED STRIP 76W 48V
Constant Voltage 48V
90-305Vac 50/60Hz

Packaging

1 Box 1,35 x 1,35 x 0,120 m
Vol 0,2187 m³
Gross weight 19,9 Kg Net weight 13,9 Kg

Notes

Extra cable length.

LED IP20 CE EAC

Multi-volt Dimmer

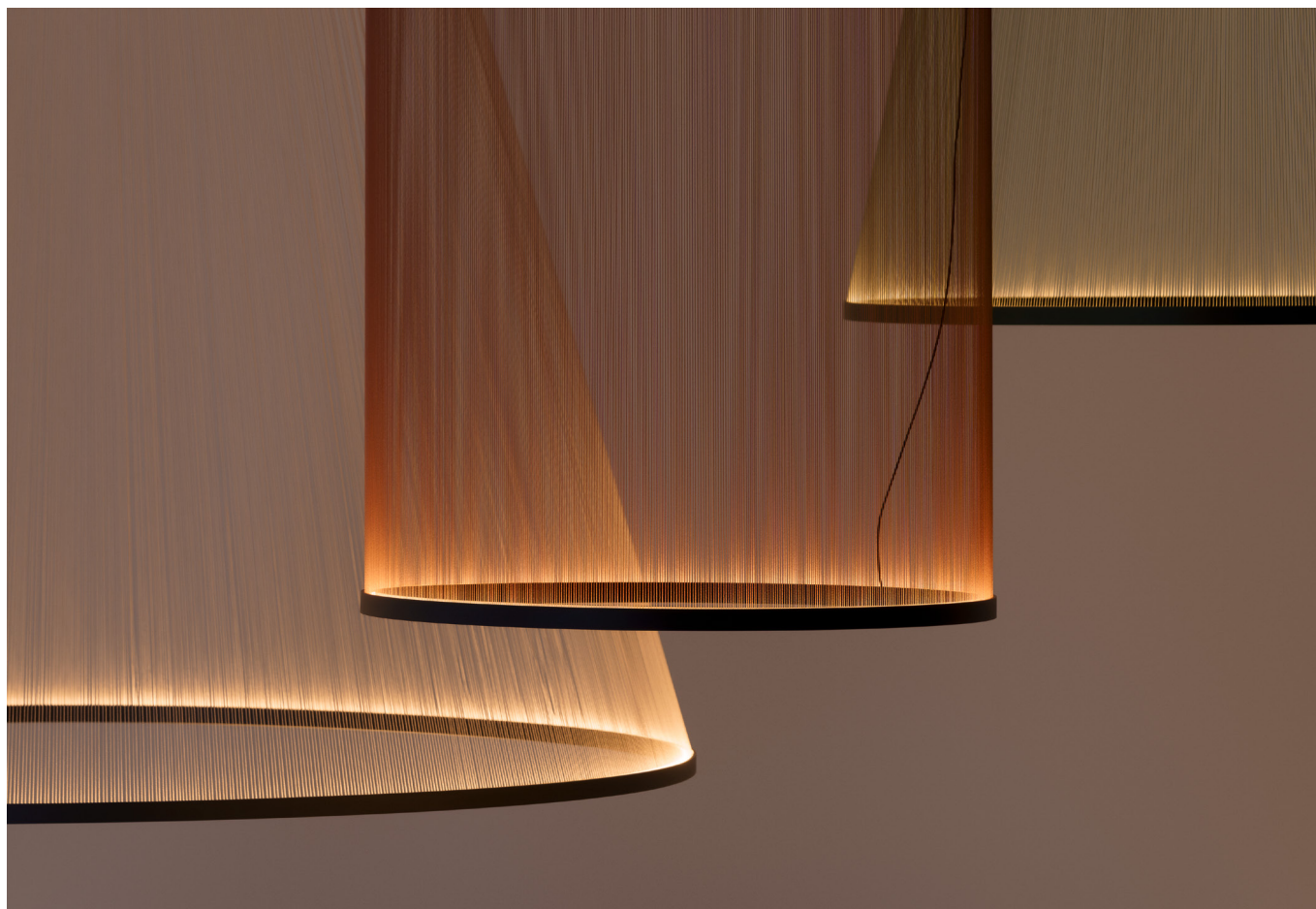

1850

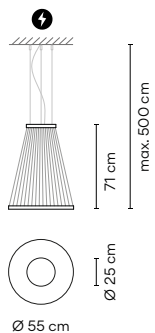

Finishes (threads)
 ● 24/ _ _ Beige M1 (NCS S 2005-Y50R)
 ● 37/ _ _ Terra Red (NCS S4040-Y70R)
 ● 47/ _ _ Green L1 (NCS S 4005-G80Y)

LED Colour Temperature
 /1_ 2700 K
 CRI >90 3993 lm 121 lm/W

Control
 1850 _ _ / _ 3
 1-10V
 1850 _ _ / _ D
 Push; DALI-2
 1850 _ _ / _ Z
 Casambi

Finishes (rings and canopy)
 ● Black (NCS S 8500-N)

Materials
 Upper ring: Aluminum. Bottom ring: Brass.
 Diffuser: PC- Polycarbonate. Threads: PES FR.

Light Source and electronics
 1 x LED STRIP 33W 48V
 Constant Voltage 48V
 90-305Vac 50/60Hz

Packaging
 1 Box 0,62 x 0,62 x 0,121 m
 Vol 0,0461 m³
 Gross weight 7,9 Kg Net weight 5,7 Kg

Notes
 Extra cable length.



Select Electrical connection
 Surface
 _24 Built-in S
 _31 Remote Micro

1855

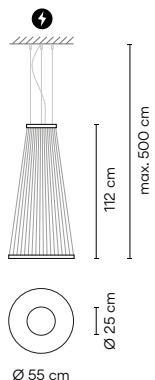

Finishes (threads)
 ● 24/ _ _ Beige M1 (NCS S 2005-Y50R)
 ● 37/ _ _ Terra Red (NCS S4040-Y70R)
 ● 47/ _ _ Green L1 (NCS S 4005-G80Y)

LED Colour Temperature
 /1_ 2700 K
 CRI >90 3993 lm 121 lm/W

Control
 1855 _ _ / _ 3
 1-10V
 1855 _ _ / _ D
 Push; DALI-2
 1855 _ _ / _ Z
 Casambi

Finishes (rings and canopy)
 ● Black (NCS S 8500-N)

Materials
 Upper ring: Aluminum. Bottom ring: Brass.
 Diffuser: PC- Polycarbonate. Threads: PES FR.

Light Source and electronics
 1 x LED STRIP 33W 48V
 Constant Voltage 48V
 90-305Vac 50/60Hz

Packaging
 1 Box 0,62 x 0,62 x 0,121 m
 Vol 0,0461 m³
 Gross weight 8,3 Kg Net weight 6,1 Kg

Notes
 Extra cable length.



Select Electrical connection
 Surface
 _24 Built-in S
 _31 Remote Micro

1860

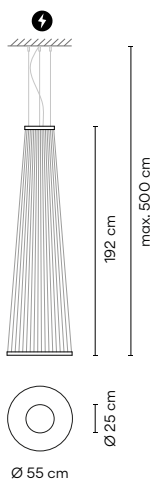

Finishes (threads)
 ● 24/ _ _ Beige M1 (NCS S 2005-Y50R)
 ● 37/ _ _ Terra Red (NCS S4040-Y70R)
 ● 47/ _ _ Green L1 (NCS S 4005-G80Y)

LED Colour Temperature
 /1_ 2700 K
 CRI >90 3993 lm 121 lm/W

Control
 1860 _ _ / _ 3
 1-10V
 1860 _ _ / _ D
 Push; DALI-2
 1860 _ _ / _ Z
 Casambi

Finishes (rings and canopy)
 ● Black (NCS S 8500-N)

Materials
 Upper ring: Aluminum. Bottom ring: Brass.
 Diffuser: PC- Polycarbonate. Threads: PES FR.

Light Source and electronics
 1 x LED STRIP 33W 48V
 Constant Voltage 48V
 90-305Vac 50/60Hz

Packaging
 1 Box 0,62 x 0,62 x 0,121 m
 Vol 0,0461 m³
 Gross weight 8,7 Kg Net weight 6,5 Kg

Notes
 Extra cable length.



Select Electrical connection
 Surface
 _24 Built-in S
 _31 Remote Micro

1865

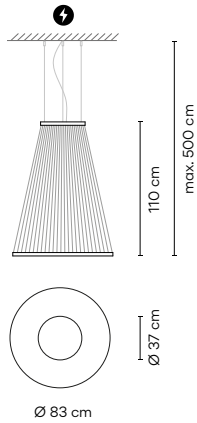

- Finishes (threads)**
- 24/ _ Beige M1 (NCS S 2005-Y50R)
 - 37/ _ Terra Red (NCS S4040-Y70R)
 - 47/ _ Green L1 (NCS S 4005-G80Y)
- LED Colour Temperature**
- /1_ 2700 K CRI >90 6050 lm 121 lm/W

Control

- 1865 _ / _ 3
1-10V
- 1865 _ / _ D
Push; DALI-2
- 1865 _ / _ Z
Casambi

- Finishes (rings and canopy)**
- Black (NCS S 8500-N)

Materials

Upper ring: Aluminum. Bottom ring: Brass.
Diffuser: PC- Polycarbonate. Threads: PES FR.

Light Source and electronics

1 x LED STRIP 50W 48V
Constant Voltage 48V
90-305Vac 50/60Hz

Packaging

1 Box 0,93 x 0,93 x 0,120 m
Vol 0,1037 m³
Gross weight 11,8 Kg Net weight 8,8 Kg

Notes

Extra cable length.



Select Electrical connection

Surface
_24 Built-in S
_31 Remote Micro

1870

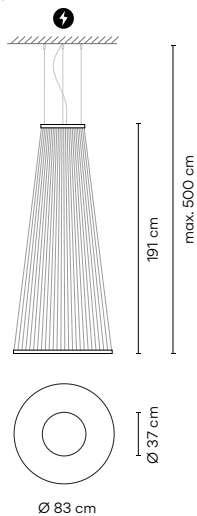

- Finishes (threads)**
- 24/ _ Beige M1 (NCS S 2005-Y50R)
 - 37/ _ Terra Red (NCS S4040-Y70R)
 - 47/ _ Green L1 (NCS S 4005-G80Y)
- LED Colour Temperature**
- /1_ 2700 K CRI >90 6050 lm 121 lm/W

Control

- 1870 _ / _ 3
1-10V
- 1870 _ / _ D
Push; DALI-2
- 1870 _ / _ Z
Casambi

- Finishes (rings and canopy)**
- Black (NCS S 8500-N)

Materials

Upper ring: Aluminum. Bottom ring: Brass.
Diffuser: PC- Polycarbonate. Threads: PES FR.

Light Source and electronics

1 x LED STRIP 50W 48V
Constant Voltage 48V
90-305Vac 50/60Hz

Packaging

1 Box 0,93 x 0,93 x 0,120 m
Vol 0,1037 m³
Gross weight 12,4 Kg Net weight 9,4 Kg

Notes

Extra cable length.



Select Electrical connection

Surface
_24 Built-in S
_31 Remote Micro

1875

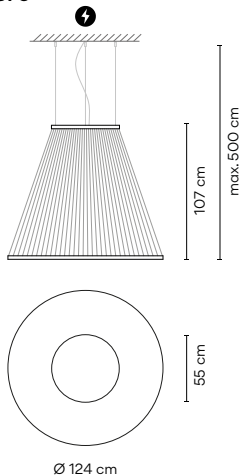

- Finishes (threads)**
- 24/ _ Beige M1 (NCS S 2005-Y50R)
 - 37/ _ Terra Red (NCS S4040-Y70R)
 - 47/ _ Green L1 (NCS S 4005-G80Y)
- LED Colour Temperature**
- /1_ 2700 K CRI >90 9196 lm 121 lm/W

Control

- 1875 _ / _ 3
1-10V
- 1875 _ / _ D
Push; DALI-2
- 1875 _ / _ Z
Casambi

- Finishes (rings and canopy)**
- Black (NCS S 8500-N)

Materials

Upper ring: Aluminum. Bottom ring: Brass.
Diffuser: PC- Polycarbonate. Threads: PES FR.

Light Source and electronics

1 x LED STRIP 76W 48V
Constant Voltage 48V
90-305Vac 50/60Hz

Packaging

1 Box 1,35 x 1,35 x 0,12 m
Vol 0,2187 m³
Gross weight 15,9 Kg Net weight 11,9 Kg

Notes

Extra cable length.



Select Electrical connection

Surface
_24 Built-in S
_31 Remote Micro

1880

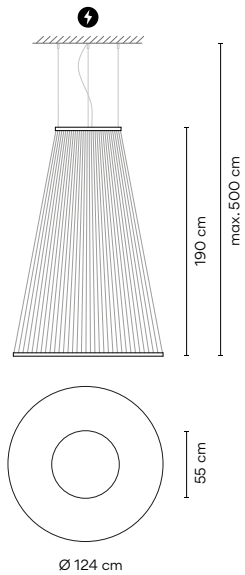

Finishes (threads) ● 24/ _ _ Beige M1 (NCS S 2005-Y50R) ● 37/ _ _ Terra Red (NCS S4040-Y70R) ● 47/ _ _ Green L1 (NCS S 4005-G80Y)	LED Colour Temperature /1_ 2700 K CRI >90 9196 lm 121lm/W	Control 1880 _ _ / _ 3 1-10V 1880 _ _ / _ D Push; DALI-2 1880 _ _ / _ Z Casambi
Finishes (rings and canopy) ● Black (NCS S 8500-N)	Materials Upper ring: Aluminum. Bottom ring: Brass. Diffuser: PC- Polycarbonate. Threads: PES FR.	Packaging 1 Box 1,35 x 1,35 x 0,12 m Vol 0,2187 m ³ Gross weight 16,8 Kg Net weight 12,8 Kg
Light Source and electronics 1 x LED STRIP 76W 48V Constant Voltage 48V 90-305Vac 50/60Hz	Notes Extra cable length.	LED IP20 CE EAC Multi-volt Dimmer

Select Electrical connection

Surface
 _24 Built-in S
 _31 Remote Micro

Electrical connection options

Choose your preferred installation option according to your needs.

Drop ceiling

Regular ceiling

_31 Remote Micro

_24 Built-in S

Surface

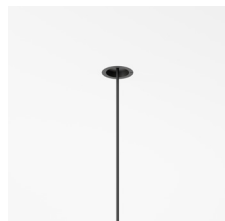

Ø 3 cm
 height 7 cm
 for plaster ceilings.
 Black finish.

Ø 8 cm
 height 6 cm
 black finish.

Ø 25,5 cm
 height 4,5 cm
 black finish.

Ø 37,5 cm
 height 4,5 cm
 black finish.



Funnel

A fluid design defines this ceiling fixture, a streamlined, funnel-shaped base that flows into a protruding cap. The smooth, sculptural curves conceal a light source behind the tip, which reflects back on the funnel form and creates a flood of ambient illumination.

Ceiling Wall

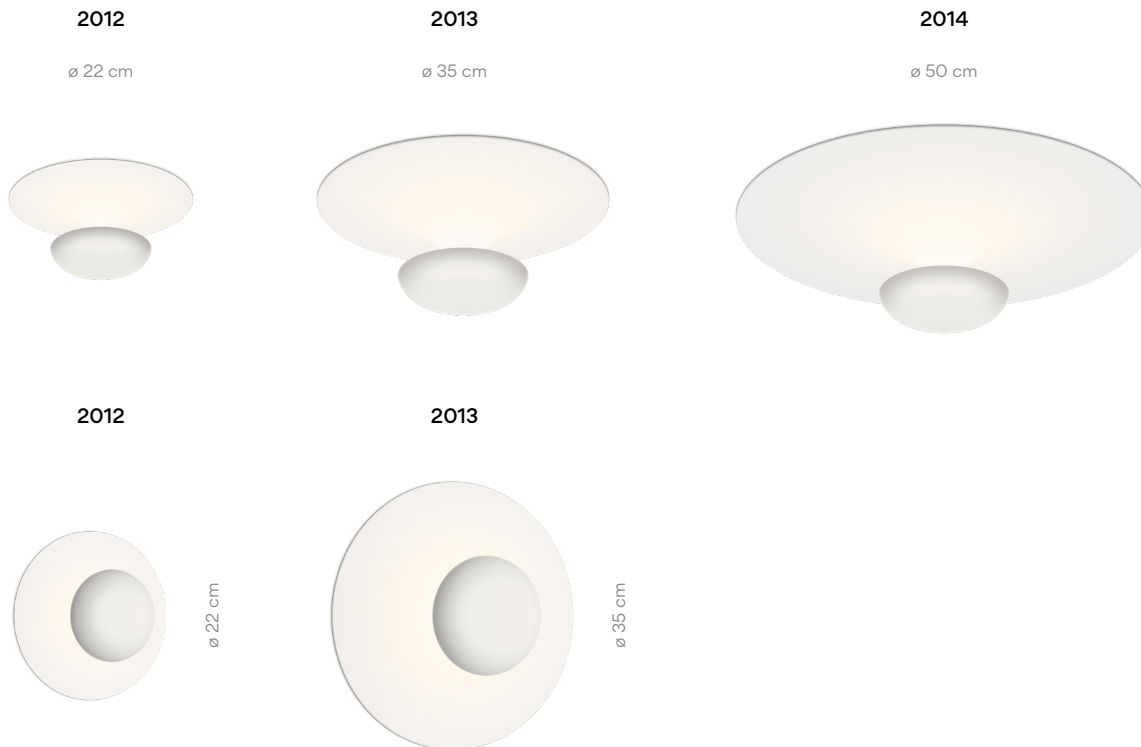

2012

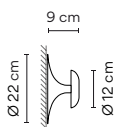
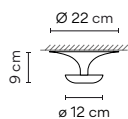

Finishes

- 10/ _ _ White (NCS S 0300-N)
- 36/ _ _ Soft Pink (NCS S 1010-Y50R)
- 47/ _ _ Green L1 (NCS S 4005-G80Y)

LED temperature colour

- /1 _ 2700 K **E** CRI >80 631,7 lm 100 lm/W
- /2 _ 3000 K **E** CRI >80 649 lm 103 lm/W
- /3 _ 3500 K **F** CRI >90 655,4 lm 104 lm/W

Control

2012 _ _ / _ 0
On/ Off

Finishes

- 51/ _ _ Gold leaf (Gold leaf)

LED temperature colour

- /1 _ 2700 K **E** CRI >80 631,7 lm 100 lm/W
- /2 _ 3000 K **E** CRI >80 649 lm 103 lm/W
- /3 _ 3500 K **F** CRI >90 655,4 lm 104 lm/W

Control

2012 _ _ / _ 0
On/ Off

Materials

Shade: Aluminum. Reflector: Aluminum.
Support: Steel.

Light Source and electronics

1 x LED PLATE 6,3 W 350 mA
Constant Current 350 mA
100~240V 50/60Hz

Packaging

1 Box 0,27 x 0,27 x 0,16 m
Vol 0,0116 m³
Gross weight 0,892 Kg Net weight 0,45 Kg





2013

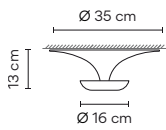

- Finishes
- 10/ __ White (NCS S 0300-N)
 - 36/ __ Soft Pink (NCS S 1010-Y50R)
 - 47/ __ Green L1 (NCS S 4005-G80Y)

- LED temperature colour
- /1 _ 2700 K CRI >80 2910 lm 121 lm/W
 - /2 _ 3000 K CRI >90 2910 lm 121 lm/W
 - /3 _ 3500 K CRI >90 3019,2 lm 125,8 lm/W

Control
 2013 __ / _ A
 DALI-2, 1-10V, Push

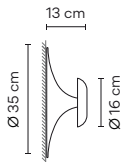

- Finishes
- 51/ __ Gold leaf (Gold leaf)

- LED temperature colour
- /1 _ 2700 K CRI >80 2910 lm 121 lm/W
 - /2 _ 3000 K CRI >90 2910 lm 121 lm/W
 - /3 _ 3500 K CRI >90 3019,2 lm 125,8 lm/W

Control
 2013 __ / _ A
 DALI-2, 1-10V, Push

Materials
 Shade: Aluminum. Reflector: Aluminum.
 Support: Steel.

Light Source and electronics
 6 x LED 4,5 W 350 mA
 Constant Current 350 mA
 110-240V 50/60Hz

Packaging
 1 Box 0,25 x 0,42 x 0,42 m
 Vol 0,0441 m³
 Gross weight 2,53 Kg Net weight 2 Kg



2014

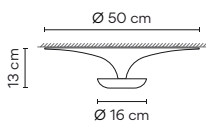

- Finishes
- 10/ __ White (NCS S 0300-N)
 - 36/ __ Soft Pink (NCS S 1010-Y50R)
 - 47/ __ Green L1 (NCS S 4005-G80Y)

- LED temperature colour
- /1 _ 2700 K CRI >80 2910 lm 121 lm/W
 - /2 _ 3000 K CRI >90 2910 lm 121 lm/W
 - /3 _ 3500 K CRI >90 3019,2 lm 125,8 lm/W

Control
 2014 __ / _ A
 DALI-2, 1-10V, Push
 2014 __ / _ Z
 Casambi

Materials
 Shade: Aluminum. Reflector: Aluminum.
 Support: Steel.

Light Source and electronics
 6 x LED 4,5 W 350 mA
 Constant Current 350 mA
 110-240V 50/60Hz

Packaging
 1 Box 0,27 x 0,60 x 0,60 m
 Vol 0,0972 m³
 Gross weight 3,782 Kg Net weight 3,3 Kg



Rhythm Horizontal

Design by Arik Levy

Evoking the mood of Zen minimalism, Rhythm features slender light modules of varying lengths, each fitted with an LED module, that can be arranged in endless configurations. Fluid and flowing or angular and anarchic, Rhythm represents the ultimate in customised lighting.

Pendants

2110

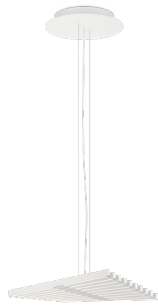

45 x 47 cm

2120



93 x 47 cm

2111

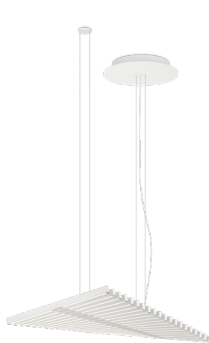

93 x 47 cm

2112



141 x 47 cm

2113



189 x 47 cm

2121



131 x 87 cm

2122



199 x 87 cm

Each project is unique.
 Personalise your own
 Rhythm composition
 quick and easy.

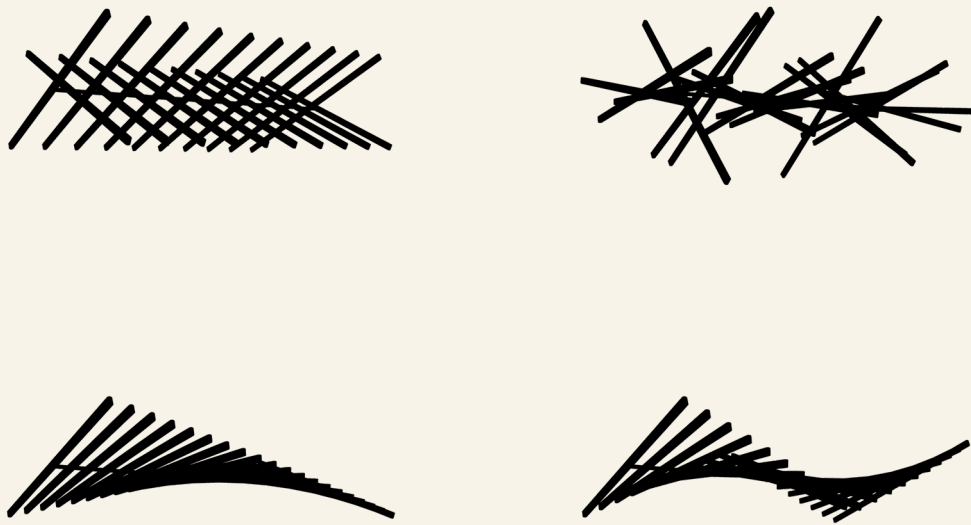

2110

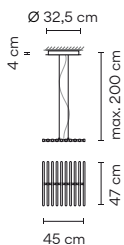

Finishes ● 14/ _ _ Chocolate (RAL 8019) ● 58/ _ _ Off-white (RAL D2-1109005)	LED temperature colour /1 _ 2700 K CRI >90 4332 lm 144 lm/W /3 _ 3500 K CRI >90 4578,7 lm 152,6 lm/W	Control 2110 _ _ / _ 1 DALI 2110 _ _ / _ 3 1-10V 2110 _ _ / _ Z Casambi
---	---	--

Materials Stick: Polyamide 6 with 10% of Fiberglass. Diffuser: Polycarbonate. Canopy: Steel. Light Source and electronics 10 x LED STRIP 30V 2,9 W Constant Voltage 30V 100~240V 50/60Hz	Packaging 2 Boxes Total Vol 0,0591 m ³ Gross weight 7,7 Kg Net weight 6 Kg Notes 2110-14 Built-in accessory (96 mm) chocolate 125,00 € 2110-58 Built-in accessory (96 mm) off-white 125,00 €
--	---

Surface and built-in fitting

 Ø 18,5 cm Only for built-in.

2111

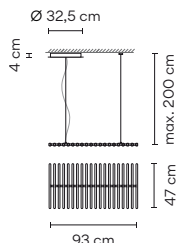

Finishes	LED temperature colour
● 14/ __ Chocolate (RAL 8019)	/1 2700 K CRI >90 8664 lm 144 lm/W
● 58/ __ Off-white (RAL D2-1109005)	/3 3500 K CRI >90 9157,3 lm 152,6 lm/W

Control
2111 __ / 1 DALI
2111 __ / 3 1-10V
2111 __ / Z Casambi

Materials
Stick: Polyamide 6 with 10% of Fiberglass.
Diffuser: Polycarbonate. Canopy: Steel.

Light Source and electronics
20 x LED STRIP 30V 2,9 W
Constant Voltage 30V
100~240V 50/60Hz

Packaging
2 Boxes
Total Vol 0,1570 m³
Gross weight 14,2 Kg Net weight 10,5 Kg

Notes
2111-14 Built-in accessory (96 mm) chocolate
2111-58 Built-in accessory (96 mm) off-white

Surface and built-in fitting



2112

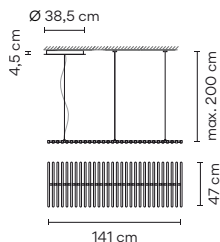

Finishes	LED temperature colour
● 14/ __ Chocolate (RAL 8019)	/1 2700 K CRI >90 12996 lm 144 lm/W
● 58/ __ Off-white (RAL D2-1109005)	/3 3500 K CRI >90 13736 lm 152,6 lm/W

Control
2112 __ / 1 DALI
2112 __ / 3 1-10V
2112 __ / Z Casambi

Materials
Stick: Polyamide 6 with 10% of Fiberglass.
Diffuser: Polycarbonate. Canopy: Steel.

Light Source and electronics
30 x LED STRIP 30V 2,9 W
Constant Voltage 30V
100~240V 50/60Hz

Packaging
2 Boxes
Total Vol 0,0430 m³
Gross weight 10,3 Kg Net weight 7 Kg

Notes
2112-14 Built-in accessory (44,5 mm) chocolate
2112-58 Built-in accessory (44,5 mm) off-white

Surface and built-in fitting



2113

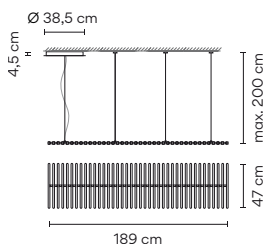

Finishes	LED temperature colour
● 14/ __ Chocolate (RAL 8019)	/1 2700 K CRI >90 17328 lm 144 lm/W
● 58/ __ Off-white (RAL D2-1109005)	/3 3500 K CRI >90 18314,6 lm 152,6 lm/W

Control
2113 __ / 1 DALI
2113 __ / 3 1-10V
2113 __ / Z Casambi

Materials
Stick: Polyamide 6 with 10% of Fiberglass.
Diffuser: Polycarbonate. Canopy: Steel.

Light Source and electronics
40 x LED STRIP 30V 2,9 W
Constant Voltage 30V
100~240V 50/60Hz

Packaging
2 Boxes
Total Vol 0,1900 m³
Gross weight 17,2 Kg Net weight 13,5 Kg

Notes
2113-14 Built-in accessory (44,5 mm) chocolate
2113-58 Built-in accessory (44,5 mm) off-white

Surface and built-in fitting



2120

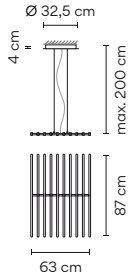

- Finishes
- 14/ __ Chocolate (RAL 8019)
 - 58/ __ Off-white (RAL D2-1109005)

- LED temperature colour
- /1 _ 2700 K CRI >90 7602,4 lm 127 lm/W
 - /3 _ 3500 K CRI >90 8035,3 lm 133,9 lm/W

- Control
- 2120 __ / _ 1 DALI
 - 2120 __ / _ 3 1-10V
 - 2120 __ / _ Z Casambi

Materials

Stick: Polyamide 6 with 10% of Fiberglass.
 Diffuser: Polycarbonate. Canopy: Steel.

Light Source and electronics

10 x LED STRIP 30V 5,8 W
 Constant Voltage 30V
 100~240V 50/60Hz

Packaging

2 Boxes
 Total Vol 0,1380 m³
 Gross weight 9,5 Kg Net weight 7,3 Kg

Notes

- 2120-14 Built-in accessory (136 mm) chocolate
- 2120-58 Built-in accessory (136 mm) off-white

Surface and built-in fitting



2121

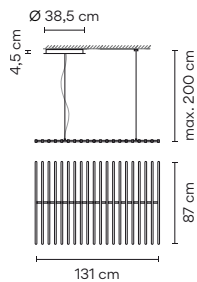

- Finishes
- 14/ __ Chocolate (RAL 8019)
 - 58/ __ Off-white (RAL D2-1109005)

- LED temperature colour
- /1 _ 2700 K CRI >90 15204,8 lm 127 lm/W
 - /3 _ 3500 K CRI >90 16070,6 lm 133,9 lm/W

- Control
- 2121 __ / _ 1 DALI
 - 2121 __ / _ 3 1-10V
 - 2121 __ / _ Z Casambi

Materials

Stick: Polyamide 6 with 10% of Fiberglass.
 Diffuser: Polycarbonate. Canopy: Steel.

Light Source and electronics

20 x LED STRIP 30V 5,8 W
 Constant Voltage 30V
 100~240V 50/60Hz

Packaging

2 Boxes
 Total Vol 0,1664 m³
 Gross weight 14,7 Kg Net weight 10,5 Kg

Notes

- 2121-14 Built-in accessory (44,5 mm) chocolate
- 2121-58 Built-in accessory (44,5 mm) off-white

Surface and built-in fitting



2122

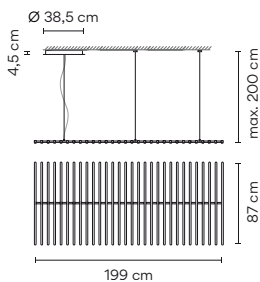

- Finishes
- 14/ __ Chocolate (RAL 8019)
 - 58/ __ Off-white (RAL D2-1109005)

- LED temperature colour
- /1 _ 2700 K CRI >90 22807,2 lm 127 lm/W
 - /3 _ 3500 K CRI >90 24105,8 lm 133,9 lm/W

- Control
- 2122 __ / _ 1 DALI
 - 2122 __ / _ 3 1-10V
 - 2122 __ / _ Z Casambi

Materials

Stick: Polyamide 6 with 10% of Fiberglass.
 Diffuser: Polycarbonate. Canopy: Steel.

Light Source and electronics

30 x LED STRIP 30V 5,8 W
 Constant Voltage 30V
 100~240V 50/60Hz

Packaging

2 Boxes
 Total Vol 0,07120 m³
 Gross weight 24 Kg Net weight 21,5 Kg

Notes

- 2122-14 Built-in accessory (44,5 mm) chocolate
- 2122-58 Built-in accessory (44,5 mm) off-white

Surface and built-in fitting



Rhythm Vertical

Design by Arik Levy

Evoking the mood of Zen minimalism, Rhythm features slender light modules of varying lengths, each fitted with an LED module, that can be arranged in endless configurations. Fluid and flowing or angular and anarchic, Rhythm represents the ultimate in customised lighting.

Pendants



Each project is unique.
Personalise your own
Rhythm composition
quick and easy.

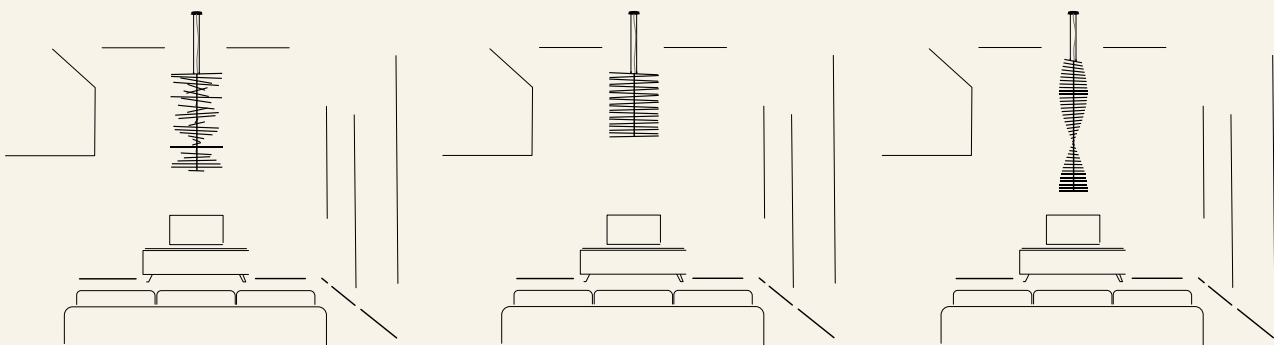

2141

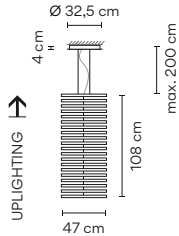

- Finishes**
- 14/ __ Chocolate (RAL 8019)
 - 58/ __ Off-white (RAL D2-1109005)

- LED temperature colour**
- /1_ 2700 K CRI >90 8664 lm 144 lm/W
 - /3_ 3500 K CRI >90 9157,3 lm 152,6 lm/W

- Control**
- 2141 __ / _ 1 DALI

- 2141 __ / _ 3 1-10V

- 2141 __ / _ Z Casambi

Materials

Stick: Polyamide 6 with 10% of Fiberglass.
 Diffuser: Polycarbonate. Canopy: Steel.

Light Source and electronics

20 x LED STRIP 30V 2,9 W
 Constant Voltage 30V
 100~240V 50/60Hz

Packaging

2 Boxes
 Total Vol 0,5850 m³
 Gross weight 10,3 Kg Net weight 7,4 Kg

Notes

2141-14 Built-in accessory (96 mm) chocolate

2141-58 Built-in accessory (96 mm) off-white

Surface and built-in fitting

Ø 18,5 cm Only for built-in.

2142

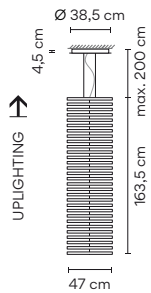

- Finishes**
- 14/ __ Chocolate (RAL 8019)
 - 58/ __ Off-white (RAL D2-1109005)

- LED temperature colour**
- /1_ 2700 K CRI >90 12996 lm 144 lm/W
 - /3_ 3500 K CRI >90 13736 lm 152,6 lm/W

- Control**
- 2142 __ / _ 1 DALI

- 2142 __ / _ 3 1-10V

- 2142 __ / _ Z Casambi

Materials

Stick: Polyamide 6 with 10% of Fiberglass.
 Diffuser: Polycarbonate. Canopy: Steel.

Light Source and electronics

30 x LED STRIP 30V 2,9 W
 Constant Voltage 30V
 100~240V 50/60Hz

Packaging

2 Boxes
 Total Vol 0,6239 m³
 Gross weight 13,7 Kg Net weight 8,2 Kg

Notes

2142-14 Built-in accessory (96 mm) chocolate

2142-58 Built-in accessory (96 mm) off-white

Surface and built-in fitting

Ø 18,5 cm Only for built-in.

2143

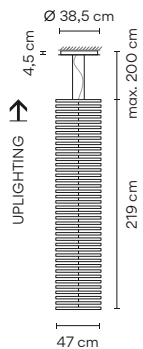

- Finishes**
- 14/ __ Chocolate (RAL 8019)
 - 58/ __ Off-white (RAL D2-1109005)

- LED temperature colour**
- /1_ 2700 K CRI >90 8664 lm 144 lm/W
 - /3_ 3500 K CRI >90 9157,3 lm 152,6 lm/W

- Control**
- 2143 __ / _ 1 DALI

- 2143 __ / _ 3 1-10V

- 2143 __ / _ Z Casambi

Materials

Stick: Polyamide 6 with 10% of Fiberglass.
 Diffuser: Polycarbonate. Canopy: Steel.

Light Source and electronics

40 x LED STRIP 30V 2,9 W
 Constant Voltage 30V
 100~240V 50/60Hz

Packaging

2 Boxes
 Total Vol 0,6600 m³
 Gross weight 16,9 Kg Net weight 13 Kg

Notes

2143-14 Built-in accessory (96 mm) chocolate

2143-58 Built-in accessory (96 mm) off-white

Surface and built-in fitting

Ø 18,5 cm Only for built-in.

Guise

Design by Stefan Diez

Crafted of precision glass and embedded with a row of recessed LEDS, Guise explores the relationship between light and transparency. The light inside the glass appears invisible while the delicately engraved surface radiates an intense glow, the markings beautifully diffusing the light.

Wall



2260

ø 54 cm



2262

ø 92 cm

2260

Finishes
● 18/ __ Graphite
(ADAPTA RF9913WX)

LED temperature colour
/2_ 3000 K 
CRI >90 445,29 lm 45 lm/W

Control
2260 __ / _ 6
Sensor

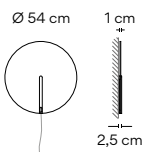







Materials
Diffuser: Borosilicate glass. LED support: Aluminum.

Light Source and electronics
1 x LED STRIP 24V 10 W
Constant Voltage 24V
100~240V 50/60Hz

Packaging
1 Box 0,69 x 0,69 x 0,09 m
Vol 0,043 m³
Gross weight 7 Kg Net weight 4 Kg

Notes
Electric cable with plug 3 m

 

2262

Finishes
● 18/ __ Graphite
(ADAPTA RF9913WX)

LED temperature colour
/2_ 3000 K 
CRI >90 897,71 lm 52 lm/W

Control
2262 __ / _ 6
Sensor

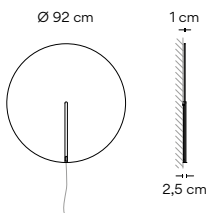





Materials
Diffuser: Borosilicate glass. LED support: Aluminum.

Light Source and electronics
1 x LED STRIP 24V 17,2 W.
Constant Voltage 24V
100~240V 50/60Hz

Packaging
1 Box 1,04 x 1,04 x 0,10 m
Vol 0,104 m³
Gross weight 16,5 Kg Net weight 11,58 Kg

Notes
Electric cable with plug 3 m

1160 10 /1A
Model Finish
LED temperature colour
Control



Pendants

2270



ø 16 cm

2271



ø 16 cm

2272



ø 16 cm

2275

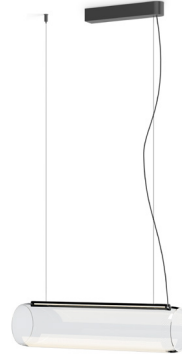

63 cm

2277

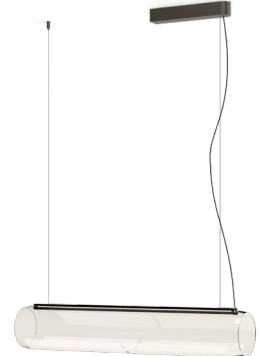

89 cm

2282



ø 25 cm

2284



ø 25 cm

2288



ø 40 cm

2270

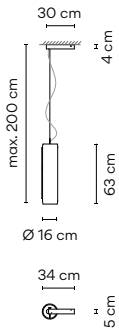

Finishes ● 18/ __ Graphite (ADAPTA RF9913WX)
 LED temperature colour /2_ 3000 K [G] CRI >90 1097,74 lm 55 lm/W

Control 2270 __ / _ 1 DALI-2

2270 __ / _ 6 Sensor

2270 __ / _ Z Casambi

Materials Diffuser: Borosilicate glass. Body: Aluminum.

Light Source and electronics 1 x LED STRIP 24V 20 W Constant Voltage 24V 110-240V 50/60Hz

Packaging 1 Box 0,87 x 0,35 x 0,37 m Vol 0,113 m³ Gross weight 6,5 Kg Net weight 5 Kg

Notes Extra cable length.

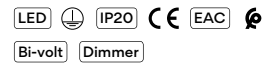

2271

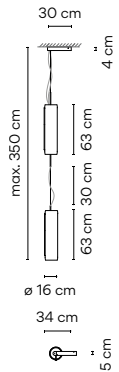

Finishes ● 18/ __ Graphite (ADAPTA RF9913WX)
 LED temperature colour /2_ 3000 K [G] CRI >90 3484,8 lm 87,12 lm/W

Control 2271 __ / _ 1 DALI-2

2271 __ / _ 3 1-10V

Materials Diffuser: Borosilicate glass. Body: Aluminum.

Light Source and electronics 2 x LED STRIP 24V 20 W Constant Voltage 24V 110-240V 50/60Hz

Packaging 2 Boxes Total Vol 0,231 m³ Gross weight 13 Kg Net weight 10 Kg

Notes Electric cable with plug 2 m. Extra cable length.

UNTIL STOCK RUNS OUT



2272

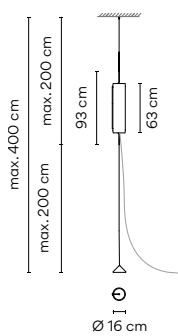

Finishes ● 18/ __ Graphite (ADAPTA RF9913WX)
 LED temperature colour /2_ 3000 K [G] CRI >90 1097,74 lm 55 lm/W

Control 2272 __ / _ 6 Sensor

Materials Diffuser: Borosilicate glass. LED support: Aluminum.

Light Source and electronics 1 x LED STRIP 24V 20 W Constant Voltage 24V 110-240V 50/60Hz

Packaging 1 Box 0,45 x 0,80 x 0,20 m Vol 0,0072 m³ Gross weight 16,10 Kg Net weight 16,10 Kg

Notes Extra cable length.



2275

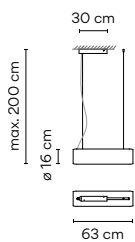

Finishes ● 18/ __ Graphite (ADAPTA RF9913WX)
 LED temperature colour /2_ 3000 K [G] CRI >90 1404,68 lm 47 lm/W

Control 2275 __ / _ 1 DALI-2

2275 __ / _ 6 Sensor

Materials Diffuser: Borosilicate glass. Body: Aluminum.

Light Source and electronics 1 x LED STRIP 24V 20 W Constant Voltage 24V 110-240V 50/60Hz

Packaging 1 Box 0,87 x 0,35 x 0,37 m Vol 0,113 m³ Gross weight 6,5 Kg Net weight 5 Kg

Notes Extra cable length.

UNTIL STOCK RUNS OUT



2277

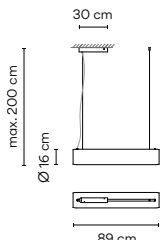

Finishes **18/** Graphite (ADAPTA RF9913WX)

LED temperature colour **/2** 3000 K CRI >90 1404,68 lm 47 lm/W

Control **2277** / **1** DALI-2

2277 / **6** Sensor

2277 / **Z** Casambi

Materials
Diffuser: Borosilicate glass. Body: Aluminum.

Light Source and electronics
1 x LED STRIP 24V 30 W
Constant Voltage 24V
100~240V 50/60Hz

Packaging
1 Box 1,18 x 0,35 x 0,37 m
Vol 0,153 m³
Gross weight 9,5 Kg Net weight 7,5 Kg

Notes
Extra cable length.



2282

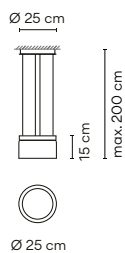

Finishes **18/** Graphite (ADAPTA RF9913WX)

LED temperature colour **/2** 3000 K CRI >90 398,74 lm 33 lm/W

Control **2282** / **1** DALI-2

2282 / **6** Sensor

2282 / **B** 1-10V, Push

2282 / **Z** Casambi

Materials
Diffuser: Borosilicate glass. Body: Aluminum.
Ceiling rose: Steel.

Light Source and electronics
1 x LED STRIP 24V 12 W
Constant Voltage 24V
110~240V 50/60Hz

Packaging
1 Box 0,41 x 0,41 x 0,38 m
Vol 0,0639 m³
Gross weight 3,3 Kg Net weight 2,3 Kg

Notes
Extra cable length.



2284

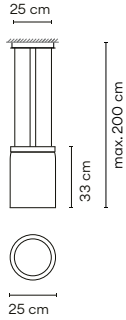

Finishes
 ● 18/ _ _ Graphite (ADAPTA RF9913WX)

LED temperature colour
 /2 _ 3000 K  CRI >90 398,74 lm 33 lm/W

Control
 2284 _ _ / _ 1 DALI-2
 2284 _ _ / _ 6 Sensor
 2284 _ _ / _ B 1-10V, Push
 2284 _ _ / _ Z Casambi

Materials
 Diffuser: Borosilicate glass. Body: Aluminum.
 Ceiling rose: Steel.

Light Source and electronics
 1 x LED STRIP 24V 12 W
 Constant Voltage 24V
 110-240V 50/60Hz

Packaging
 1 Box 0,41 x 0,41 x 0,56 m
 Vol 0,0941 m³
 Gross weight 6,2 Kg Net weight 5,2 Kg

Notes
 Extra cable length.
UNTIL STOCK RUNS OUT



2288

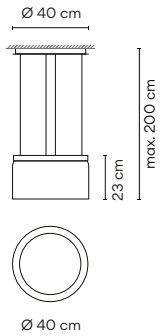

Finishes
 ● 18/ _ _ Graphite (ADAPTA RF9913WX)

LED temperature colour
 /2 _ 3000 K  CRI >90 868,87 lm 48 lm/W

Control
 2288 _ _ / _ 1 DALI-2
 2288 _ _ / _ 6 Sensor
 2288 _ _ / _ B 1-10V, Push
 2288 _ _ / _ Z Casambi

Materials
 Diffuser: Borosilicate glass. Body: Aluminum.
 Ceiling rose: Steel.

Light Source and electronics
 1 x LED STRIP 24V 18 W
 Constant Voltage 24V
 110-240V 50/60Hz

Packaging
 1 Box 0,56 x 0,56 x 0,46 m
 Vol 0,1443 m³
 Gross weight 11,7 Kg Net weight 9,7 Kg

Notes
 Extra cable length.

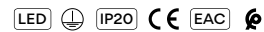

Ceiling

2292

ø 25 cm



2294

ø 25 cm



2298

ø 40 cm



2292

Finishes
 ● 18/ _ _ Graphite (ADAPTA RF9913WX)

LED temperature colour
 /2 _ 3000 K  CRI >90 398,74 lm 33 lm/W

Control
 2292 _ _ / _ 1 DALI-2

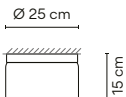

2292 _ _ / _ B
 1-10V, Push
 2292 _ _ / _ Z
 Casambi



Materials
 Diffuser: Borosilicate glass. Body: Aluminum.

Packaging
 1 Box 0,41 x 0,41 x 0,33 m
 Vol 0,0555 m³
 Gross weight 3,2 Kg Net weight 2,2 Kg

Light Source and electronics
 1 x LED STRIP 24V 12 W
 Constant Voltage 24V
 110-240V 50/60Hz

    

2294

Finishes
 ● 18/ _ _ Graphite (ADAPTA RF9913WX)

LED temperature colour
 /2 _ 3000 K  CRI >90 398,74 lm 33 lm/W

Control
 2294 _ _ / _ 1 DALI-2

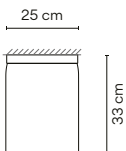

2294 _ _ / _ B
 1-10V, Push
 2294 _ _ / _ Z
 Casambi



Materials
 Diffuser: Borosilicate glass. Body: Aluminum.

Packaging
 1 Box 0,41 x 0,41 x 0,51 m
 Vol 0,0857 m³
 Gross weight 6,1 Kg Net weight 5,1 Kg

Light Source and electronics
 1 x LED STRIP 24V 12 W
 Constant Voltage 24V
 110-240V 50/60Hz

NOTES
UNTIL STOCK RUNS OUT
    

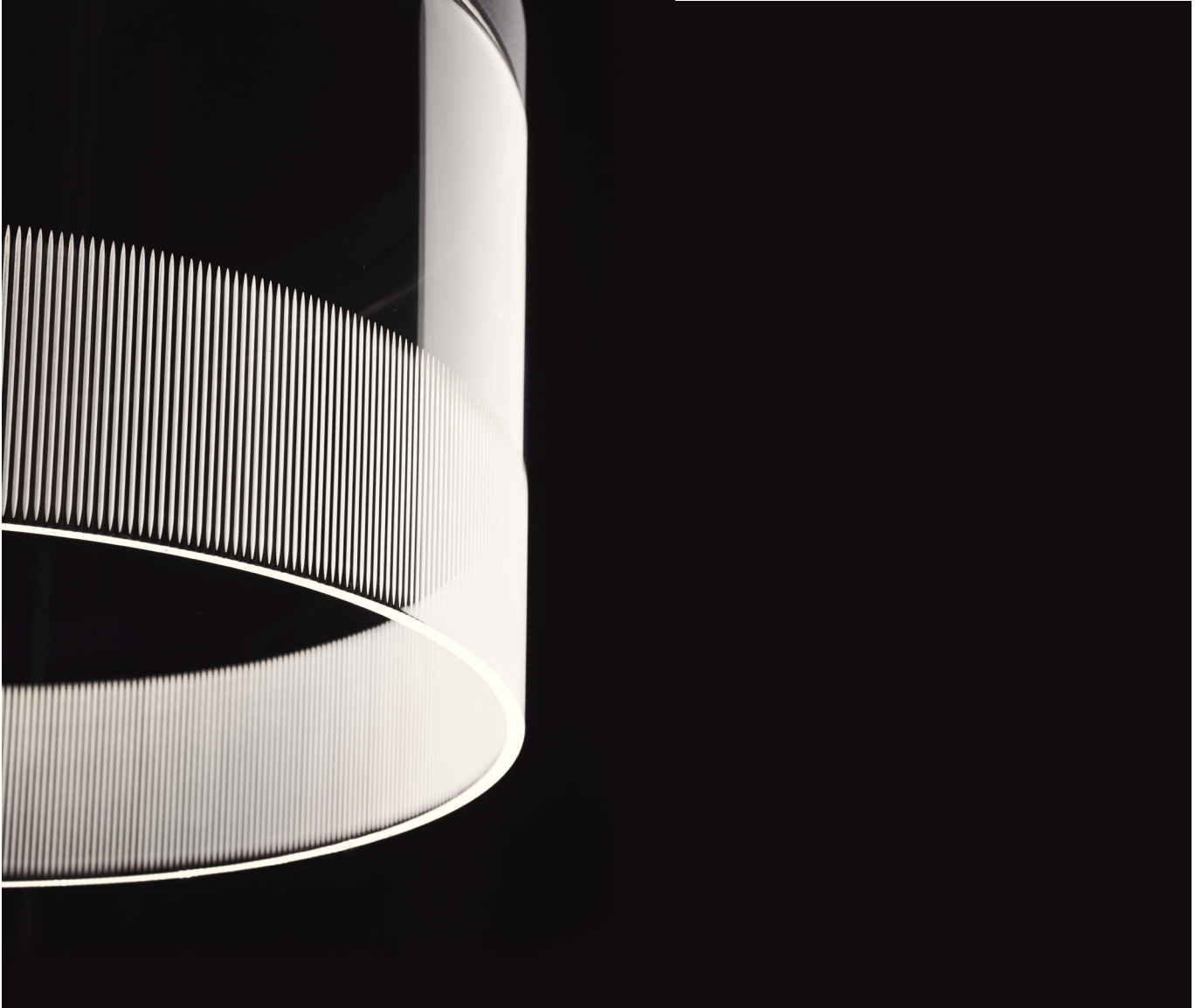

2298

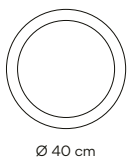
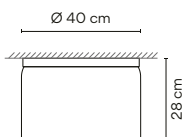

Finishes
 ● 18/ _ _ Graphite (ADAPTA RF9913WX)

LED temperature colour
 /2_ 3000 K CRI >90 398,74 lm 22 lm/W

Control
 2298 _ _ / _ 1 DALI-2

2298 _ _ / _ B 1-10V, Push

2298 _ _ / _ Z Casambi

Materials
 Diffuser: Borosilicate glass. Body: Aluminum.

Light Source and electronics
 1 x LED STRIP 24V 18 W
 Constant Voltage 24V
 220~240V 50/60Hz

Packaging
 1 Box 0,56 x 0,56 x 0,46 m
 Vol 0,1443 m³
 Gross weight 13,3 Kg Net weight 11,3 Kg

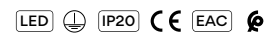

Halo Circular

Design by Martín Azúa

A seamless merging of light and matter, Halo lends the effect of light floating in air. Powered by LED bulbs that remain invisible within their opalized, spherical moulds, the light flows freely from its source.

Pendants



ø 55,5 cm

2330

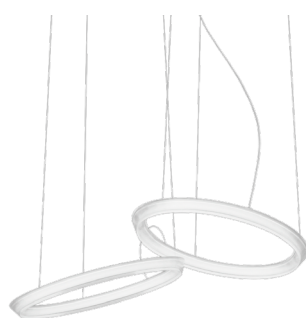

89 cm

2331

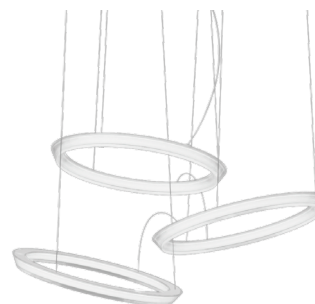

127 cm

2332

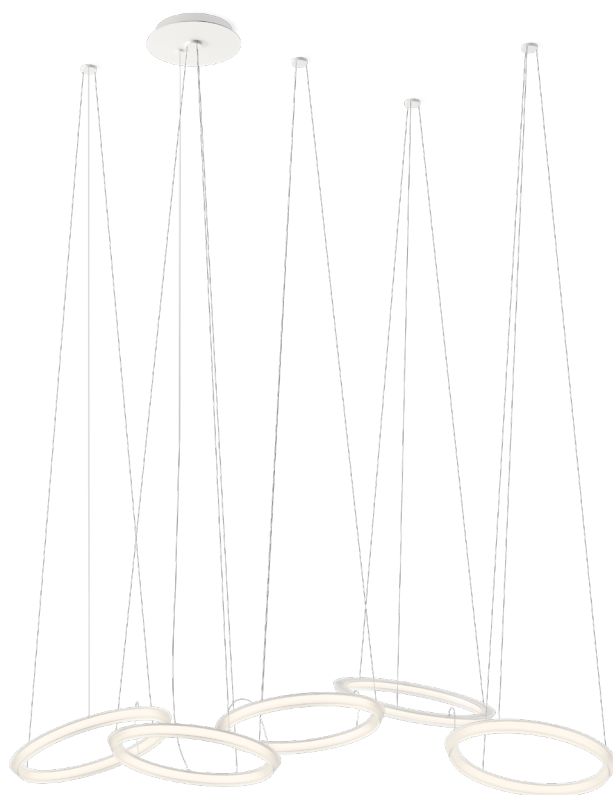

197 cm

2333

Each project is unique.
Personalise your own
Halo composition
quick and easy.

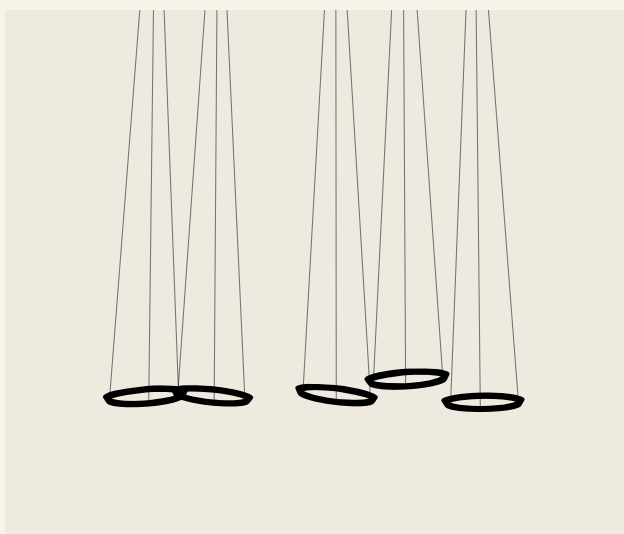
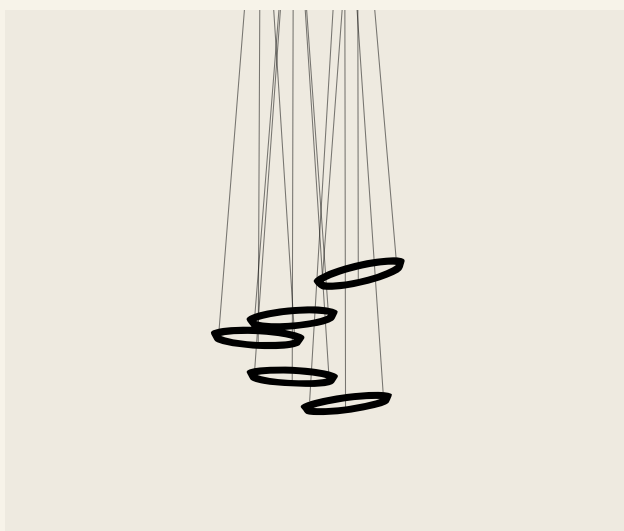

2330

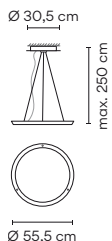

Finishes

- 03/ __ White (RAL 9016)

LED temperature colour

- /1_ 2700 K CRI >90 1904 lm 82 lm/W
- /2_ 3000 K CRI >80 1726,78 lm 75 lm/W

Control

- 2330 __ / _ 1 DALI
- 2330 __ / _ 3 1-10V
- 2330 __ / _ Z Casambi

Materials

Diffuser: PMMA. Canopy: Steel

Light Source and electronics

1 x LED STRIP 24V 23 W
Constant Voltage 24V
100~277V 50/60Hz

Packaging

1 Box 0,60 x 0,60 x 0,27 m
Vol 0,0972 m³
Gross weight 5,75 Kg Net weight 3,75 Kg



2331

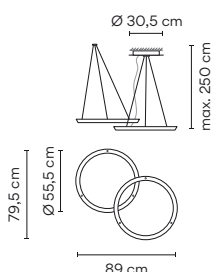

Finishes

- 03/ __ White (RAL 9016)

LED Colour Temperature

- /1_ 2700 K CRI >90 3808 lm 82 lm/W
- /2_ 3000 K CRI >80 3453,56 lm 75 lm/W

Control

- 2331 __ / _ 1 DALI
- 2331 __ / _ 3 1-10V
- 2331 __ / _ Z Casambi

Materials

Diffuser: PMMA. Canopy: Steel

Light Source and electronics

2 x LED STRIP 24V 23 W
Constant Voltage 24V
100~277V 50/60Hz

Packaging

1 Box 0,60 x 0,60 x 0,27 m
Vol 0,0972 m³
Gross weight 10,25 Kg Net weight 6,25 Kg



2332

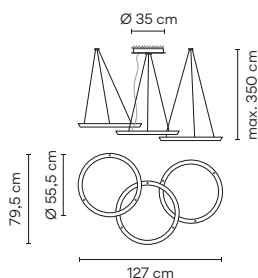

Finishes

- 03/ __ White (RAL 9016)

LED Colour Temperature

- /1_ 2700 K CRI >90 5712 lm 82 lm/W
- /2_ 3000 K CRI >80 5180,34 lm 75 lm/W

Control

- 2332 __ / _ 1 DALI
- 2332 __ / _ 3 1-10V
- 2332 __ / _ Z Casambi

Materials

Diffuser: PMMA. Canopy: Steel

Light Source and electronics

3 x LED STRIP 24V 23 W
Constant Voltage 24V
100~277V 50/60Hz

Packaging

1 Box 0,60 x 0,60 x 0,27 m
Vol 0,0972 m³
Gross weight 14,75 Kg Net weight 8,75 Kg



2333

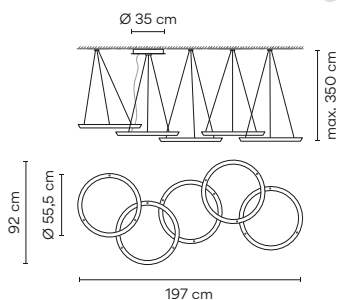

Finishes

- 03/ __ White (RAL 9016)

LED Colour Temperature

- /1_ 2700 K CRI >90 9520 lm 82 lm/W
- /2_ 3000 K CRI >80 8633,9 lm 75 lm/W

Control

- 2333 __ / _ 1 DALI
- 2333 __ / _ 3 1-10V
- 2333 __ / _ Z Casambi

Materials

Diffuser: PMMA. Canopy: Steel

Light Source and electronics

5 x LED STRIP 24V 23 W
Constant Voltage 24V
100~277V 50/60Hz

Packaging

2 Boxes
Total Vol 0,1106 m³
Gross weight 23,75 Kg Net weight 13,75 Kg





Halo Lineal

Design by Martín Azúa

A seamless merging of light and matter, Halo lends the effect of light floating in air. Powered by LED bulbs that remain invisible within their opalized, linear moulds, the light flows freely from its source.

Pendants

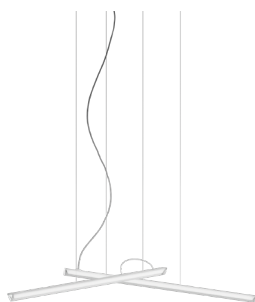

152 cm

2340

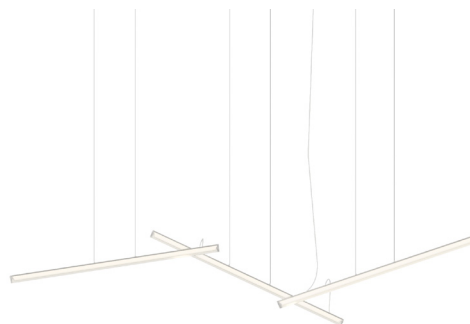

204 cm

2341

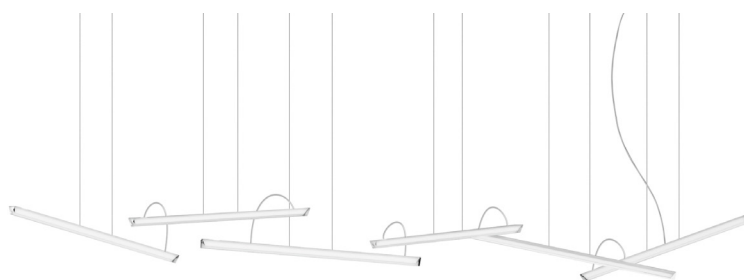

336 cm

2342

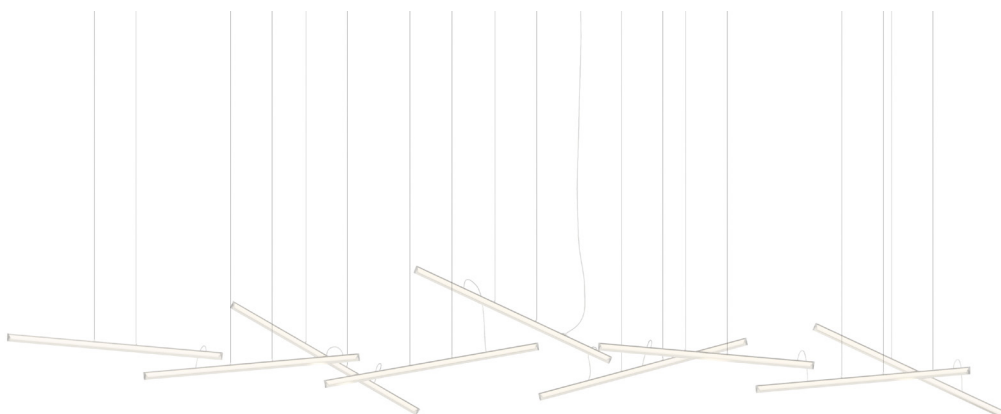

500 cm

2343

Each project is unique.
Personalise your own
Halo composition
quick and easy.

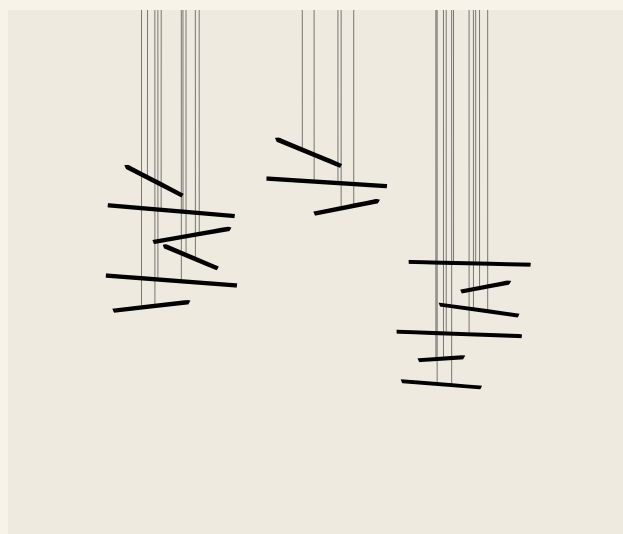
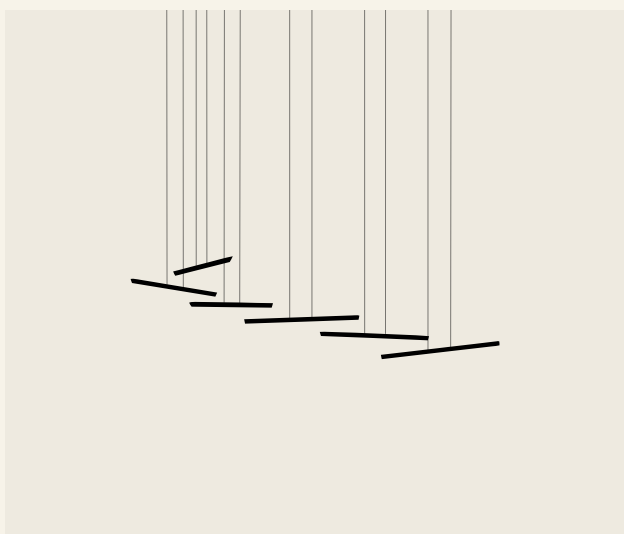
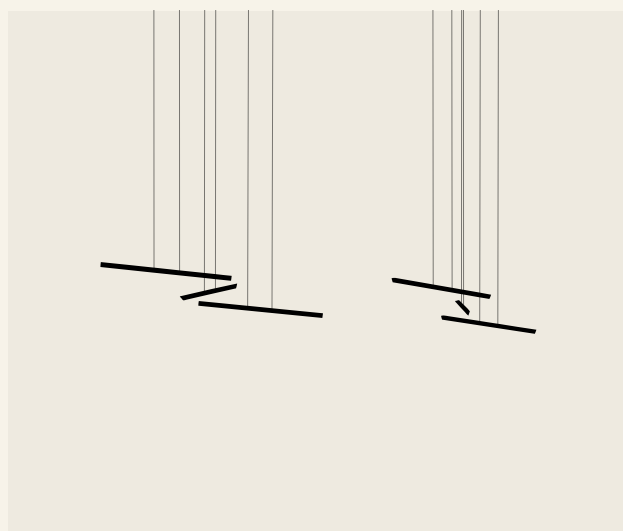
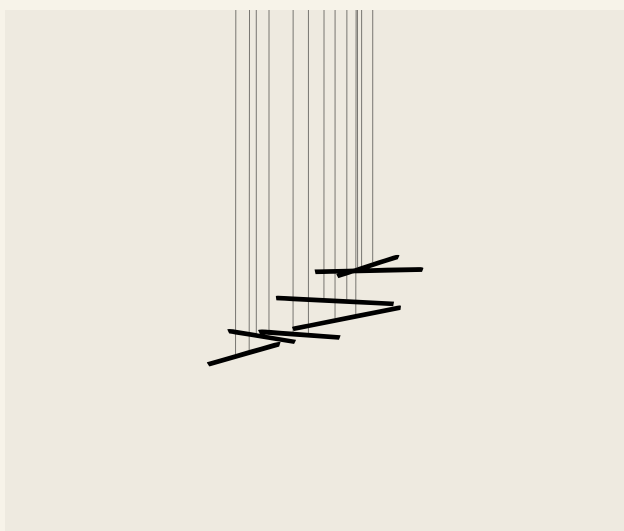

2340

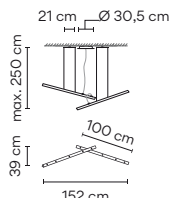

Finishes
● 03/ __ White (RAL 9016)

LED Colour Temperature
/1 _ 2700 K **F**
CRI >90 2831 lm 94 lm/W
/2 _ 3000 K **G**
CRI >80 2567,18 lm 84 lm/W

Control
2340 __ / _ 1
DALI
2340 __ / _ 3
1-10V
2340 __ / _ Z
Casambi

Materials
Diffuser: PMMA. Canopy: Steel
Light Source and electronics
2 x LED STRIP 24V 15,3 W
Constant Voltage 24V
100~277V 50/60Hz

Packaging
2 Boxes
Total Vol 0,0753 m³
Gross weight 6,2 Kg Net weight 5,58 Kg
LED IP20 CE EAC Multi-volt

2341

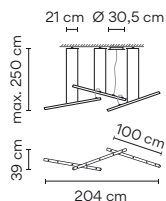

Finishes
● 03/ __ White (RAL 9016)

LED Colour Temperature
/1 _ 2700 K **F**
CRI >90 4246 lm 94 lm/W
/2 _ 3000 K **G**
CRI >80 3850,77 lm 84 lm/W

Control
2341 __ / _ 1
DALI
2341 __ / _ 3
1-10V
2341 __ / _ Z
Casambi

Materials
Diffuser: PMMA. Canopy: Steel
Light Source and electronics
3 x LED STRIP 24V 15,3 W
Constant Voltage 24V
100~277V 50/60Hz

Packaging
2 Boxes
Total Vol 0,0753 m³
Gross weight 7,3 Kg Net weight 6,57 Kg
LED IP20 CE EAC Multi-volt

2342

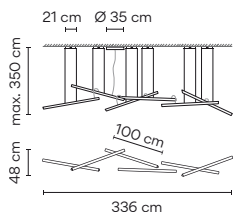

Finishes
● 03/ __ White (RAL 9016)

LED Colour Temperature
/1 _ 2700 K **F**
CRI >90 8492 lm 94 lm/W
/2 _ 3000 K **G**
CRI >80 7701,54 lm 84 lm/W

Control
2342 __ / _ 1
DALI
2342 __ / _ 3
1-10V
2342 __ / _ Z
Casambi

Materials
Diffuser: PMMA. Canopy: Steel
Light Source and electronics
6 x LED STRIP 24V 15,3 W
Constant Voltage 24V
100~277V 50/60Hz

Packaging
2 Boxes
Total Vol 0,0756 m³
Gross weight 11,8 Kg Net weight 10,25 Kg
LED IP20 CE EAC Multi-volt

2343

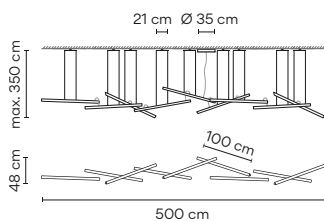

Finishes
● 03/ __ White (RAL 9016)

LED Colour Temperature
/1 _ 2700 K **F**
CRI >90 12739 lm 94 lm/W
/2 _ 3000 K **G**
CRI >80 11552,31 lm 84 lm/W

Control
2343 __ / _ 1
DALI
2343 __ / _ 3
1-10V
2343 __ / _ Z
Casambi

Materials
Diffuser: PMMA. Canopy: Steel
Light Source and electronics
9 x LED STRIP 24V 15,3 W
Constant Voltage 24V
100~277V 50/60Hz

Packaging
2 Boxes
Total Vol 0,0756 m³
Gross weight 16,20 Kg Net weight 14,75 Kg
LED IP20 CE EAC Multi-volt



Halo Jewel

Design by Martín Azúa

Subtle light floating in the air and delicately suspended by a perfectly crafted steel structure. Light and matter in one.

Pendants

2350

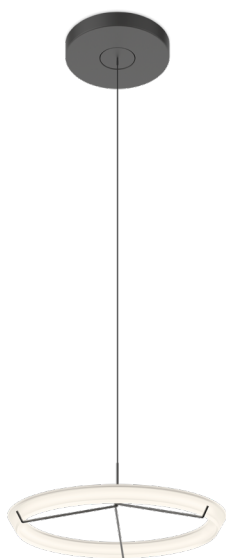

ø 56,3 cm

2351

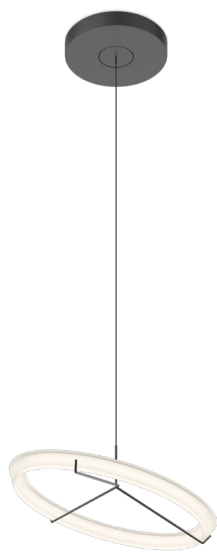

ø 56,3 cm

2355

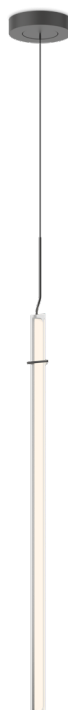

max. 350 cm

2356

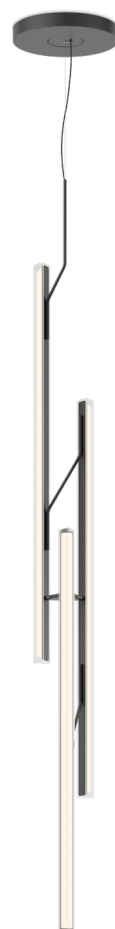

max. 350 cm

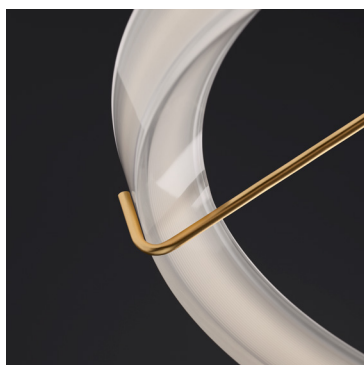

1160 10 / 1A _18

Model
 Finish
 LED temperature colour
 Control
 Electrical connection
 Only for pendants

2350

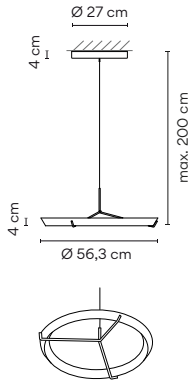

Finishes
 ● 11/ _ _ Black
 (NCS S 8500-N)

LED Colour Temperature
 /1 _ 2700 K **G**
 CRI >90 1904 lm 83 lm/W
 /2 _ 3000 K **F**
 CRI >80 2024 lm 88 lm/W

Control
 2350 _ _ / _ 1
 DALI
 2350 _ _ / _ 3
 1-10V
 2350 _ _ / _ Z
 Casambi

Finishes
 ● 20/ _ _ Gold
 (Gold)

LED Colour Temperature
 /1 _ 2700 K **G**
 CRI >90 1904 lm 83 lm/W
 /2 _ 3000 K **F**
 CRI >80 2024 lm 88 lm/W

Control
 2350 _ _ / _ 1
 DALI
 2350 _ _ / _ 3
 1-10V
 2350 _ _ / _ Z
 Casambi

Materials

Diffuser: Methacrylate. LED support: Aluminum.
 Pendant structure: Steel. Ceiling rose: Steel.

Light Source and electronics

1 x LED STRIP 24V 23 W
 Constant Voltage 24V
 100~277V 50/60Hz

Packaging

1 Box 0,6 x 0,6 x 0,27 m
 Vol 0,097 m³
 Gross weight 7 Kg Net weight 6,35 Kg

Notes

Extra cable length.



Electrical connection

Surface
 _18 Free Wire
 _23 Built-in
 _31 Remote
 Micro
 for plaster ceilings
 _32 Remote
 XXS
 for all types
 of drop
 ceilings

2351

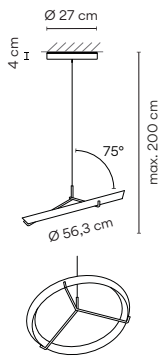

Finishes
 ● 11/ _ _ Black
 (NCS S 8500-N)

LED Colour Temperature
 /1 _ 2700 K **G**
 CRI >90 1904 lm 83 lm/W
 /2 _ 3000 K **F**
 CRI >80 2024 lm 88 lm/W

Control
 2351 _ _ / _ 1
 DALI
 2351 _ _ / _ 3
 1-10V
 2351 _ _ / _ Z
 Casambi

Finishes
 ● 20/ _ _ Gold
 (Gold)

LED Colour Temperature
 /1 _ 2700 K **G**
 CRI >90 1904 lm 83 lm/W
 /2 _ 3000 K **F**
 CRI >80 2024 lm 88 lm/W

Control
 2351 _ _ / _ 1
 DALI
 2351 _ _ / _ 3
 1-10V
 2351 _ _ / _ Z
 Casambi

Materials

Diffuser: Methacrylate. LED support: Aluminum.
 Pendant structure: Steel. Ceiling rose: Steel.

Light Source and electronics

1 x LED STRIP 24V 23 W
 Constant Voltage 24V
 100~277V 50/60Hz

Packaging

1 Box 0,6 x 0,6 x 0,27 m
 Vol 0,097 m³
 Gross weight 7 Kg Net weight 6,35 Kg

Notes

Extra cable length.



Electrical connection

Surface
 _18 Free Wire
 _23 Built-in
 _31 Remote
 Micro
 for plaster ceilings
 _32 Remote
 XXS
 for all types
 of drop
 ceilings

2355

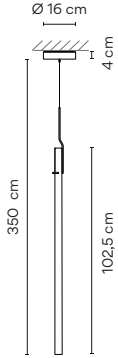

Finishes	LED Colour Temperature	Control
● 11/ __ Black (NCS S 8500-N)	/1 _ 2700 K CRI >90 1415 lm 94 lm/W /2 _ 3000 K CRI >80 1224 lm 80 lm/W	2355 __ / _ 1 DALI 2355 __ / _ 3 1-10V 2355 __ / _ Z Casambi

Finishes	LED Colour Temperature	Control
● 20/ __ Gold (Gold)	/1 _ 2700 K CRI >90 1415 lm 94 lm/W /2 _ 3000 K CRI >80 1224 lm 80 lm/W	2355 __ / _ 1 DALI 2355 __ / _ 3 1-10V 2355 __ / _ Z Casambi

Materials	Packaging
Diffuser: Methacrylate. LED support: Aluminum. Pendant structure: Steel. Ceiling rose: Steel.	1 Box 0,13 x 0,19 x 1,265 m Vol 0,0312 m ³ Gross weight 5 Kg Net weight 4,1 Kg
Light Source and electronics	Notes
1 x LED STRIP 24V 15,3 W Constant Voltage 24V 220-240V 50/60Hz	Extra cable length.



Electrical connection

- Surface
- _18 Free Wire
- _23 Built-in
- _31 Remote
- Micro for plaster ceilings
- _32 Remote XXS for all types of drop ceilings

2356

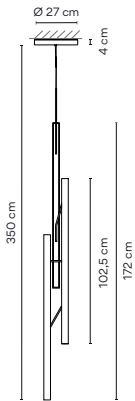

Finishes	LED Colour Temperature	Control
● 11/ __ Black (NCS S 8500-N)	/1 _ 2700 K CRI >90 4246 lm 94 lm/W /2 _ 3000 K CRI >80 3672 lm 80 lm/W	2356 __ / _ 1 DALI 2356 __ / _ 3 1-10V 2356 __ / _ Z Casambi

Finishes	LED Colour Temperature	Control
● 20/ __ Gold (Gold)	/1 _ 2700 K CRI >90 4246 lm 94 lm/W /2 _ 3000 K CRI >80 3672 lm 80 lm/W	2356 __ / _ 1 DALI 2356 __ / _ 3 1-10V 2356 __ / _ Z Casambi

Materials	Packaging
Diffuser: Methacrylate. LED support: Aluminum. Pendant structure: Steel. Ceiling rose: Steel.	1 Box 0,31 x 0,33 x 2 m Vol 0,2046 m ³ Gross weight 7,4 Kg Net weight 6,06 Kg
Light Source and electronics	Notes
3 x LED STRIP 24V 15,3 W Constant Voltage 24V 100-277V 50/60Hz	Extra cable length.





Composing pendants

Next sketches are composed by one or more compositions

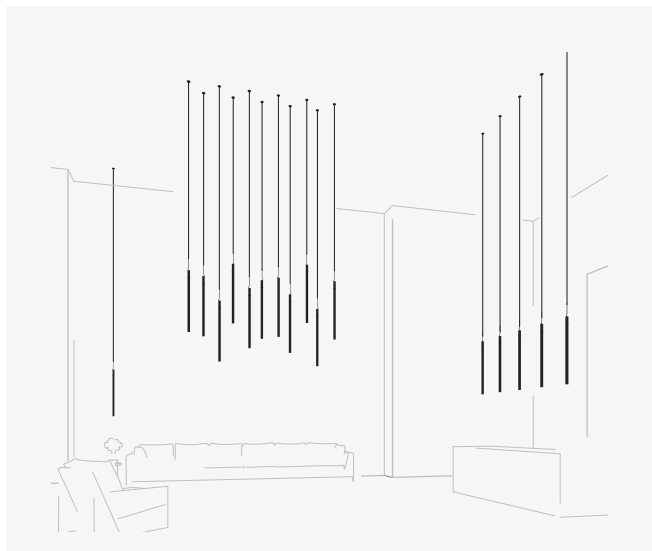

17 x 2355.



1 x 2350 and 2 x 2351.

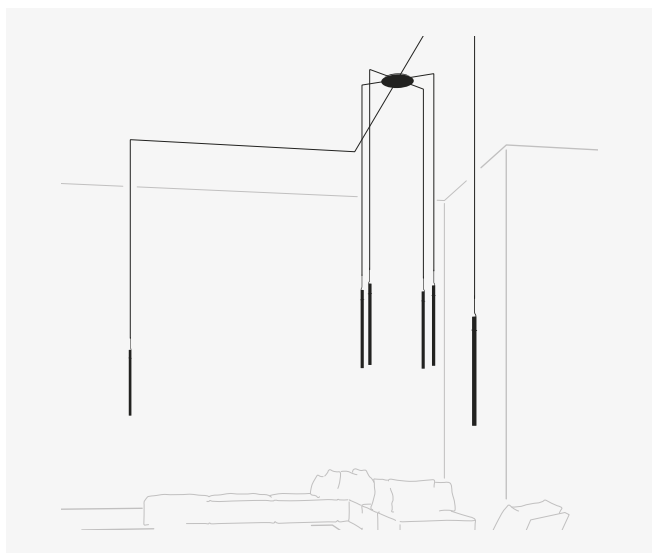

6 x 2355.

Each project is unique.
Visit vibia.com and
chose among multiple
compositions designed
and adapted to your
project needs.

Personalise your own
Halo composition quick
and easy at vibia.com



Electrical connection options for models 2350 / 2351 / 2355

Choose your preferred installation option
according to your needs.
For each composition, the optimal minimum
number of drivers will be delivered.

Drop ceiling

The innovative remote and built-in fittings accentuate
the silkiness and lightness of compositions on
suspended ceilings, its great visual grandeur taking
center stage.

For Ref. 2350 / 2351 / 2355

Remote

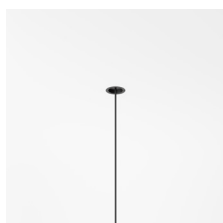

Micro \varnothing 3 cm
height 7 cm
for plaster ceilings.
Black finish.

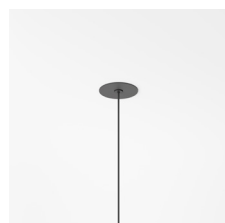
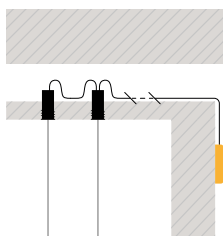

XXS \varnothing 6 cm
height 6 cm
for all types of drop
ceilings. Match with
fixture finish.

Built-in



\varnothing 8 cm
height 6 cm
match with
fixture finish.

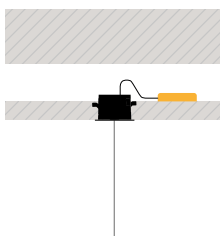

Regular ceiling

When architecture does not allow for performance, surface and free wire showcase possibilities for any need or desire with no limits, ideal for both individual or cluster arrangements.

For Ref. 2350 / 2351

Surface



ø 27 cm
match with
fixture finish.

Free Wire

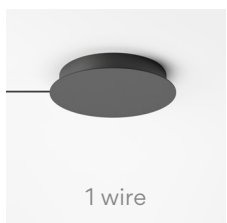

1 wire

ø 22 cm



2 - 6 wires

ø 36 cm

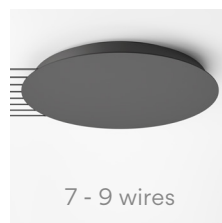

7 - 9 wires

ø 40 cm

For Ref. 2355

Surface

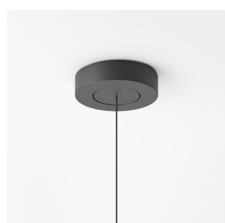

ø 16 cm
match with
fixture finish.

Free Wire

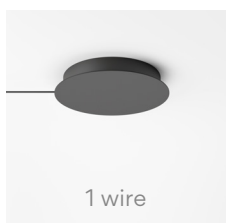

1 wire

ø 20 cm



2 - 6 wires

ø 36 cm

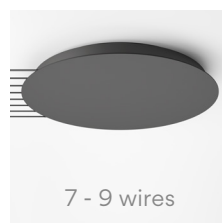

7 - 9 wires

ø 40 cm

you can choose the finish of the canopy
among black, white or any colour
matching one of the pendants.

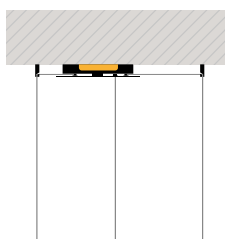
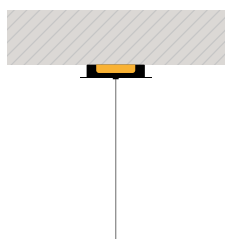

Halo Wall



Design by Martín Azúa

A seamless merging of light and matter, Halo Wall lends the effect of light floating in the air and bathing the walls. A feature piece which creates subtle, magical light.

Wall



2360

- | | |
|---|---|
| Finishes | LED Colour Temperature |
| ● 11/ _ _ Black
(NCS S 8500-N) | /1 _ 2700 K  |
| ● 13/ _ _ Warm White
(NCS S 1000-N) | /2 _ 3000 K  |

Control

- | |
|----------------------------------|
| 2360 _ _ / _ 1
DALI |
| 2360 _ _ / _ 3
1-10V |
| 2360 _ _ / _ Z
Casambi |

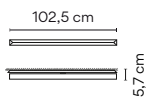

Materials

Diffuser: Methacrylate. LED support: Aluminum.

Light Source and electronics

1 x LED STRIP 24V 15,3 W
Constant Voltage 24V
220-240V 50/60Hz

Packaging

1 Box 0,10 x 1,025 x 0,10 m
Vol 0,01 m³
Gross weight 2,25 Kg Net weight 1,75 Kg

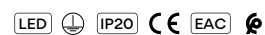

2361

- Finishes**
- 11/ __ Black (NCS S 8500-N)
 - 13/ __ Warm White (NCS S 1000-N)
- LED Colour Temperature**
- /1 _ 2700 K CRI >90 1415 lm 94 lm/W
 - /2 _ 3000 K CRI >80 3672 lm 80 lm/W

- Control**
- 2361 __ / _ 1 DALI
 - 2361 __ / _ 3 1-10V
 - 2361 __ / _ Z Casambi

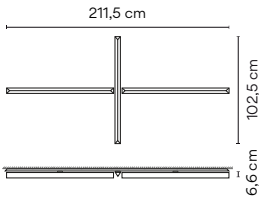

Materials
 Diffuser: Methacrylate. LED support: Aluminum.

Light Source and electronics
 3 x LED STRIP 24V 15,3 W
 Constant Voltage 24V
 220-240V 50/60Hz

Packaging
 1 Box 0,15 x 2,20 x 0,15 m
 Vol 0,05 m³
 Gross weight 5,5 Kg Net weight 4,5 Kg

Notes
 The rotation around a central axis allows for movement of the light sticks in the desired position: perpendicular, vertical, diagonal and progressive, creating wall arts in the space.

UNTIL STOCK RUNS OUT

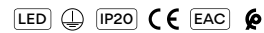

2362

- Finishes**
- 11/ __ Black (NCS S 8500-N)
 - 13/ __ Warm White (NCS S 1000-N)
- LED Colour Temperature**
- /1 _ 2700 K CRI >90 1415 lm 94 lm/W
 - /2 _ 3000 K CRI >80 6120 lm 80 lm/W

- Control**
- 2362 __ / _ 1 DALI
 - 2362 __ / _ 3 1-10V
 - 2362 __ / _ Z Casambi

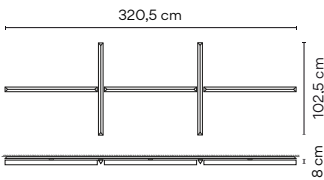

Materials
 Diffuser: Methacrylate. LED support: Aluminum.

Light Source and electronics
 5 x LED STRIP 24V 15,3 W
 Constant Voltage 24V
 220-240V 50/60Hz

Packaging
 1 Box 0,15 x 3,40 x 0,15 m
 Vol 0,077 m³
 Gross weight 9,5 Kg Net weight 7,5 Kg

Notes
 The rotation around a central axis allows for movement of the light sticks in the desired position: perpendicular, vertical, diagonal and progressive, creating wall arts in the space.

UNTIL STOCK RUNS OUT

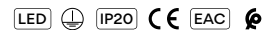

Cosmos

Design by Lievore, Altherr, Molina

Design and light become one with Cosmos pendant. Flattened spheres in suspension that naturally descend from the ceiling and use light to draw a fluctuating course like a constellation of stars.

Pendants

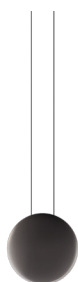

ø 19 cm

2500

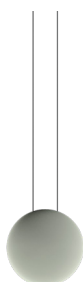

ø 27 cm

2501



ø 48 cm

2502



55 cm

2510



55 cm

2511



76 cm

2515



86 cm

2516

2500

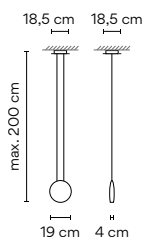

Finishes

- **14/** __ Chocolate (RAL 8019)
- **62/** __ Green (PANTONE 5645)
- **66/** __ Light-grey (PANTONE 403)

LED temperature colour

- /1 2700 K CRI >80 485 lm 121 lm/W
- /3 3500 K CRI >90 512,6 lm 128,2 lm/W

Control

- 2500** __ / __ 0 On/ Off
- 2500** __ / __ 1 DALI-2
- 2500** __ / __ Z Casambi

Materials

Diffuser: Polycarbonate. Body: ABS.
Canopy Plate: Steel.

Light Source and electronics

1 x LED 4,5 W 350mA
Constant Current 350 mA
/ 10: 100-240V 50/60Hz
/ 1B: 110-240V 50/60Hz

Packaging

1 Box 0,26 x 0,26 x 0,26 m
Vol 0,0180 m³
Gross weight 1,62 Kg Net weight 1,18 Kg

Notes

Extra cable length.

2501

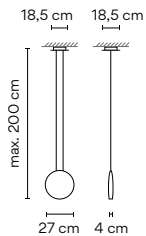

- Finishes**
- 14/ __ Chocolate (RAL 8019)
 - 62/ __ Green (PANTONE 5645)
 - 66/ __ Light-grey (PANTONE 403)

- LED temperature colour**
- /1_ 2700 K CRI >80 485 lm 121 lm/W
 - /3_ 3500 K CRI >90 512,6 lm 128,2 lm/W

- Control**
- 2501 __ / _ 0 On/ Off
 - 2501 __ / _ 1 DALI-2
 - 2501 __ / _ Z Casambi

Materials
 Diffuser: Polycarbonate. Body: ABS.
 Canopy Plate: Steel.

Light Source and electronics
 1 x LED 4,5 W 350mA
 Constant Current 350 mA
 / 10: 100-240V 50/60Hz
 / 1B: 110-240V 50/60Hz

Packaging
 1 Box 0,42 x 0,42 x 0,25 m
 Vol 0,0441 m³
 Gross weight 2,54 Kg Net weight 1,44 Kg

Notes
 Extra cable length.



2502

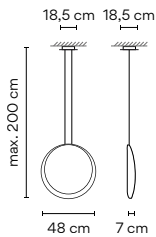

- Finishes**
- 03/ __ White (RAL 9010)

- LED temperature colour**
- /1_ 2700 K CRI >80 485 lm 121 lm/W
 - /3_ 3500 K CRI >90 512,6 lm 128,2 lm/W

- Control**
- 2502 __ / _ 1 DALI-2
 - 2502 __ / _ B 1-10V, Push
 - 2502 __ / _ Z Casambi

Materials
 Diffuser: Polycarbonate. Body: Polyurethane.
 Canopy Plate: Steel.

Light Source and electronics
 1 x LED 4,5 W 350 mA.
 1 x LED 1 W 350 mA.
 Constant Current 350 mA
 110-240V 50/60Hz

Packaging
 1 Box 0,60 x 0,60 x 0,27 m
 Vol 0,0970 m³
 Gross weight 5,58 Kg Net weight 3,15 Kg

Notes
 Extra cable length.



2510

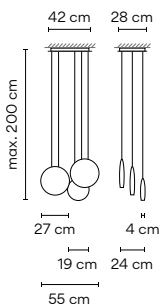

- Finishes**
- 62/ __ Green, Chocolate and Light-grey (PANTONE 5645, RAL 8019, PANTONE 403)

- LED temperature colour**
- /1_ 2700 K CRI >80 1455 lm 121 lm/W
 - /3_ 3500 K CRI >90 1537,8 lm 128,2 lm/W

- Control**
- 2510 __ / _ A DALI-2, 1-10V, Push
 - 2510 __ / _ Z Casambi

Materials
 Diffuser: Polycarbonate. Body: ABS.
 Canopy Plate: Steel.

Light Source and electronics
 3 x LED 4,5 W 350 mA
 Constant Current 350 mA
 110-240V 50/60Hz

Packaging
 1 Box 0,60 x 0,60 x 0,27 m
 Vol 0,0970 m³
 Gross weight 7,54 Kg Net weight 5,11 Kg

Notes
 Compositions and finishes can not be changed
 Extra cable length.



2511

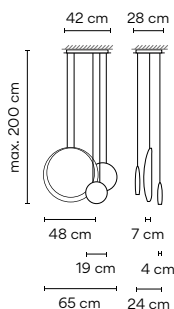

<p>Finishes</p> <ul style="list-style-type: none"> ● 62/ __ Green, White and Chocolate (PANTONE 5645, RAL 9010, RAL 8019) ● 66/ __ Light-grey, White and Chocolate (PANTONE 403, RAL 9010, RAL 8019) 	<p>LED temperature colour</p> <p>/1 _ 2700 K CRI >80 1455 lm 121 lm/W</p> <p>/3 _ 3500 K CRI >90 1537,8 lm 128,2 lm/W</p>	<p>Control</p> <p>2511 __ / _ A DALI-2, 1-10V, Push</p> <hr/> <p>2511 __ / _ Z Casambi</p>
<p>Materials</p> <p>Diffuser: Polycarbonate. Body: ABS + Polyurethane. Canopy Plate: Steel.</p> <p>Light Source and electronics</p> <p>3 x LED 4,5 W 350 mA 1 x LED 1 W 350 mA Constant Current 350 mA 110-240V 50/60Hz</p>	<p>Packaging</p> <p>1 Box 0,60 x 0,60 x 0,27 m Vol 0,0970 m³ Gross weight 9,25 Kg Net weight 6,82 Kg</p> <p>Notes</p> <p>Compositions and finishes can not be changed Extra cable length.</p>	

LED IP20

2515

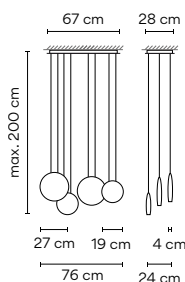

<p>Finishes</p> <ul style="list-style-type: none"> ● 62/ __ Green, Chocolate and Light-grey (PANTONE 5645, RAL 8019, PANTONE 403) 	<p>LED temperature colour</p> <p>/1 _ 2700 K CRI >80 1940 lm 121 lm/W</p> <p>/3 _ 3500 K CRI >90 2050,5 lm 128,2 lm/W</p>	<p>Control</p> <p>2515 __ / _ A DALI-2, 1-10V, Push</p> <hr/> <p>2515 __ / _ Z Casambi</p>
<p>Materials</p> <p>Diffuser: Polycarbonate. Body: ABS. Canopy Plate: Steel.</p> <p>Light Source and electronics</p> <p>4 x LED 4,5 W 350 mA Constant Current 350 mA 110-240V 50/60Hz</p>	<p>Packaging</p> <p>1 Box 0,76 x 0,76 x 0,27 m Vol 0,1560 m³ Gross weight 10,94 Kg Net weight 7,04 Kg</p> <p>Notes</p> <p>Compositions and finishes can not be changed Extra cable length.</p>	

LED IP20

2516

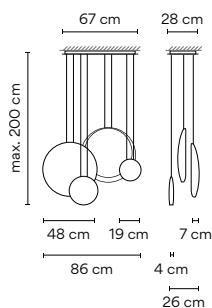

<p>Finishes</p> <ul style="list-style-type: none"> ● 62/ __ Green, White and Chocolate (PANTONE 5645, RAL 9010, RAL 8019) 	<p>LED temperature colour</p> <p>/1 _ 2700 K CRI >80 1940 lm 121 lm/W</p>	<p>Control</p> <p>2516 __ / _ A DALI-2, 1-10V, Push</p> <hr/> <p>2516 __ / _ Z Casambi</p>
<p>Materials</p> <p>Diffuser: Polycarbonate. Body: ABS + Polyurethane. Canopy Plate: Steel.</p> <p>Light Source and electronics</p> <p>4 x LED 4,5 W 350 mA 2x LED 1 W 350 mA Constant Current 350 mA 110-240V 50/60Hz</p>	<p>Packaging</p> <p>1 Box 0,73x0,73x0,32 m Vol 0,1705 m³ Gross weight 14,62 Kg Net weight 15,5 Kg</p> <p>Notes</p> <p>Compositions and finishes can not be changed Extra cable length.</p>	

LED IP20



Structural

Design by Arik Levy

Structural's cubic forms pair with slender metal rods that both join and separate the volumes, providing points of light connected in space. Its design deconstructs the light source and casts it in unexpected places, creating sculptural pieces integrated in the architecture.

Wall

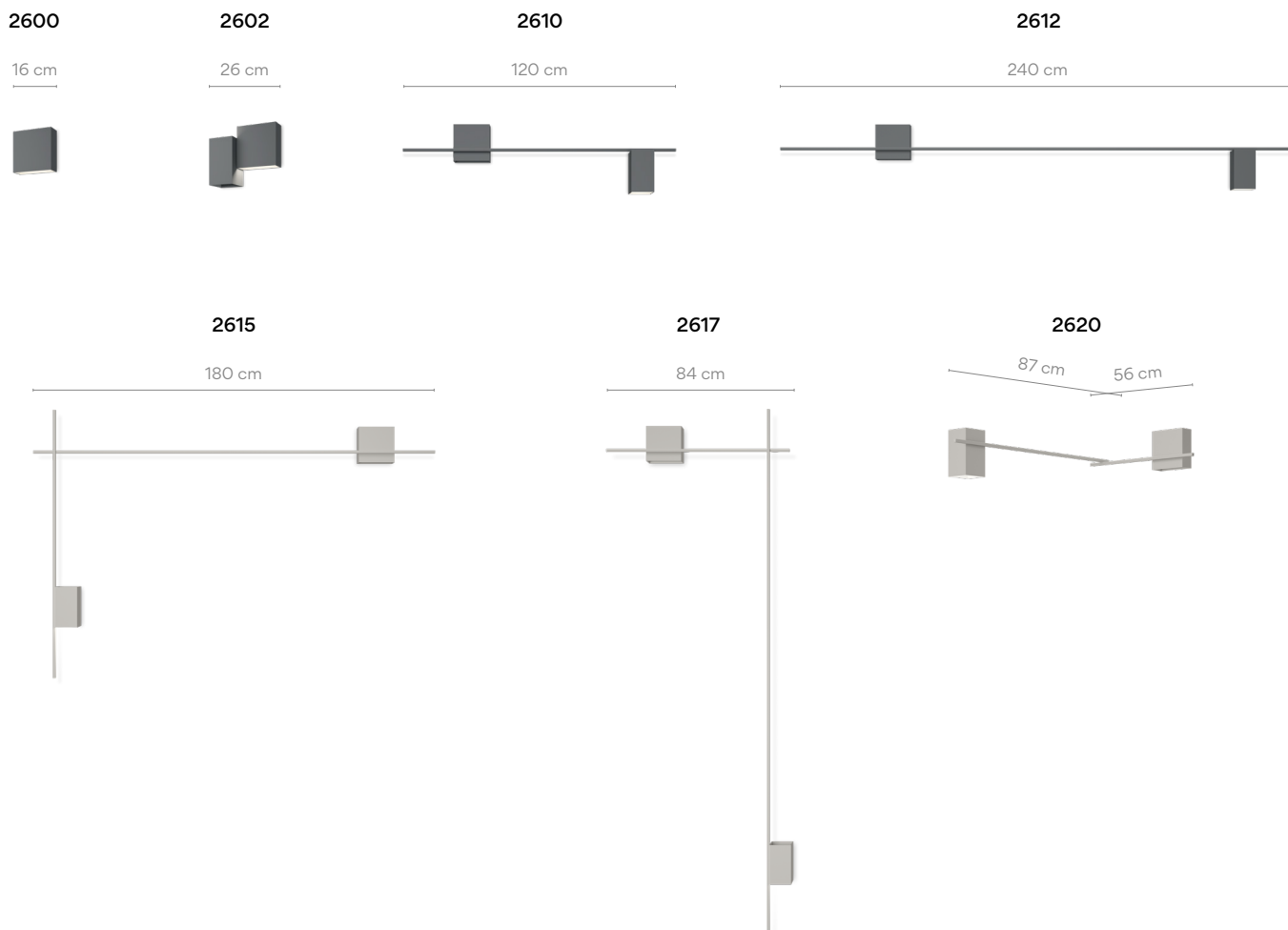

2600

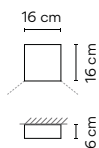

- Finishes**
- **21/ _ _ Black Grey** (NCS S 7000-N)
- **15/ _ _ Grey L2** (NCS S 2500-N)
- Finish customization** (Available options: Vibia colour palette)
- LED Colour Temperature**
- /1_ 2700 K** CRI >90 700 lm 117 lm/W
- /2_ 3000 K** CRI >90 756,73 lm 126 lm/W
- /3_ 3500 K** CRI >90 763,3 lm 127,2 lm/W

- Control**
- 2600 _ _ / _ 1** DALI-2
- 2600 _ _ / _ 3** 1-10V
- 2600 _ _ / _ Z** Casambi

Materials
Diffuser: Polycarbonate. Main body: Aluminum.
Structures: Aluminum.

Light Source and electronics
1 x LED PLATE 24V 6 W
Constant Voltage 24V
110-240V 50/60Hz

Packaging
1 Box 0,4 x 0,4 x 0,2 m
Vol 0,032 m³
Gross weight 1,35 Kg Net weight 0,9 Kg



2602

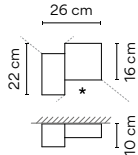

- | | |
|---|---|
| Finishes
<ul style="list-style-type: none"> ● 21/ _ _ Black Grey (NCS S 7000-N) ● 15/ _ _ Grey L2 (NCS S 2500-N) Finish customization
(Available options: Vibia colour palette) | LED Colour Temperature
/1 _ 2700 K <input type="checkbox"/>
CRI >90 1400 lm 117 lm/W |
| | /2 _ 3000 K <input type="checkbox"/>
CRI >90 1513,46 lm 126 lm/W |
| | /3 _ 3500 K <input type="checkbox"/>
CRI >90 1526,5 lm 127,2 lm/W |

- Control**
 2602 _ _ / _ 1
 DALI-2
 2602 _ _ / _ 3
 1-10V
 2602 _ _ / _ Z
 Casambi

Materials

Diffuser: Polycarbonate. Main body: Aluminum.
 Structures: Aluminum.

Light Source and electronics

2 x LED PLATE 24V 6 W
 Constant Voltage 24V
 110-240V 50/60Hz

Packaging

1 Box 0,4 x 0,4 x 0,2 m
 Vol 0,032 m³
 Gross weight 2,85 Kg Net weight 1,9 Kg

Notes

* Electrical connection point.



2610

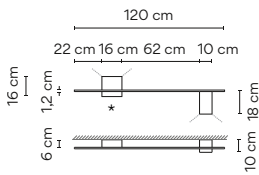

- | | |
|---|---|
| Finishes
<ul style="list-style-type: none"> ● 21/ _ _ Black Grey (NCS S 7000-N) ● 15/ _ _ Grey L2 (NCS S 2500-N) Finish customization
(Available options: Vibia colour palette) | LED Colour Temperature
/1 _ 2700 K <input type="checkbox"/>
CRI >90 1400 lm 117 lm/W |
| | /2 _ 3000 K <input type="checkbox"/>
CRI >90 1513,46 lm 126 lm/W |
| | /3 _ 3500 K <input type="checkbox"/>
CRI >90 1526,5 lm 127,2 lm/W |

- Control**
 2610 _ _ / _ 1
 DALI-2
 2610 _ _ / _ 3
 1-10V
 2610 _ _ / _ Z
 Casambi

Materials

Diffuser: Polycarbonate. Main body: Aluminum.
 Structures: Aluminum.

Light Source and electronics

1 x LED PLATE 24V 6 W
 Constant Voltage 24V
 110-240V 50/60Hz

Packaging

2 Boxes
 Total Vol 0,036 m³
 Gross weight 3,6 Kg Net weight 2,4 Kg

Notes

* Electrical connection point.



2612

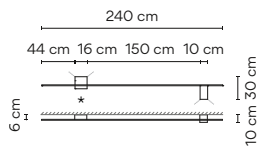

- | | |
|---|---|
| Finishes
<ul style="list-style-type: none"> ● 21/ _ _ Black Grey (NCS S 7000-N) ● 15/ _ _ Grey L2 (NCS S 2500-N) Finish customization
(Available options: Vibia colour palette) | LED Colour Temperature
/1 _ 2700 K <input type="checkbox"/>
CRI >90 1400 lm 117 lm/W |
| | /2 _ 3000 K <input type="checkbox"/>
CRI >90 1513,46 lm 126 lm/W |
| | /3 _ 3500 K <input type="checkbox"/>
CRI >90 1526,5 lm 127,2 lm/W |

- Control**
 2612 _ _ / _ 1
 DALI-2
 2612 _ _ / _ 3
 1-10V
 2612 _ _ / _ Z
 Casambi

Materials

Diffuser: Polycarbonate. Main body: Aluminum.
 Structures: Aluminum.

Light Source and electronics

2 x LED PLATE 24V 6 W
 Constant Voltage 24V
 110-240V 50/60Hz

Packaging

2 Boxes
 Total Vol 0,042 m³
 Gross weight 3,9 Kg Net weight 2,6 Kg

Notes

* Electrical connection point.



2615

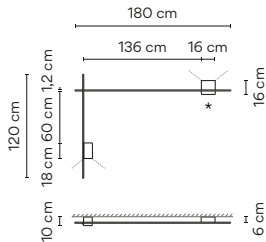

<p>Finishes</p> <ul style="list-style-type: none"> ● 21/ _ _ Black Grey (NCS S 7000-N) ● 15/ _ _ Grey L2 (NCS S 2500-N) <p>Finish customization (Available options: Vibia colour palette)</p>	<p>LED Colour Temperature</p> <ul style="list-style-type: none"> /1_ 2700 K F CRI >90 1400 lm 117 lm/W /2_ 3000 K E CRI >90 1513,46 lm 126 lm/W /3_ 3500 K E CRI >90 1526,5 lm 127,2 lm/W 	<p>Control</p> <p>2615 _ _ / _ 1 DALI-2</p> <hr/> <p>2615 _ _ / _ 3 1-10V</p> <hr/> <p>2615 _ _ / _ Z Casambi</p>
<p>Materials</p> <p>Diffuser: Polycarbonate. Main body: Aluminum. Structures: Aluminum.</p>	<p>Packaging</p> <p>2 Boxes Total Vol 0,038 m³ Gross weight 4,35 Kg Net weight 2,9 Kg</p>	
<p>Light Source and electronics</p> <p>2 x LED PLATE 24V 6 W Constant Voltage 24V 110~240V 50/60Hz</p>		
<p>Notes</p> <p>* Electrical connection point.</p>		
<p>LED IP20 CE EAC Bi-volt </p>		

2617

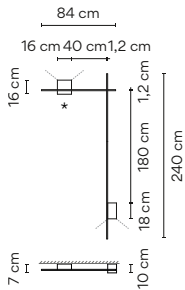

<p>Finishes</p> <ul style="list-style-type: none"> ● 21/ _ _ Black Grey (NCS S 7000-N) ● 15/ _ _ Grey L2 (NCS S 2500-N) <p>Finish customization (Available options: Vibia colour palette)</p>	<p>LED Colour Temperature</p> <ul style="list-style-type: none"> /1_ 2700 K F CRI >90 1400 lm 117 lm/W /2_ 3000 K E CRI >90 1513,46 lm 126 lm/W /3_ 3500 K E CRI >90 1526,5 lm 127,2 lm/W 	<p>Control</p> <p>2617 _ _ / _ 1 DALI-2</p> <hr/> <p>2617 _ _ / _ 3 1-10V</p> <hr/> <p>2617 _ _ / _ Z Casambi</p>
<p>Materials</p> <p>Diffuser: Polycarbonate. Main body: Aluminum. Structures: Aluminum.</p>	<p>Packaging</p> <p>2 Boxes Total Vol 0,041 m³ Gross weight 4,35 Kg Net weight 2,9 Kg</p>	
<p>Light Source and electronics</p> <p>2 x LED PLATE 24V 6 W Constant Voltage 24V 110~240V 50/60Hz</p>		
<p>Notes</p> <p>* Electrical connection point.</p>		
<p>LED IP20 CE EAC Bi-volt </p>		

2620

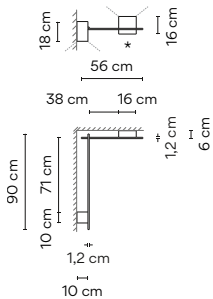

<p>Finishes</p> <ul style="list-style-type: none"> ● 21/ _ _ Black Grey (NCS S 7000-N) ● 15/ _ _ Grey L2 (NCS S 2500-N) <p>Finish customization (Available options: Vibia colour palette)</p>	<p>LED Colour Temperature</p> <ul style="list-style-type: none"> /1_ 2700 K F CRI >90 1400 lm 117 lm/W /2_ 3000 K E CRI >90 1513,46 lm 126 lm/W /3_ 3500 K E CRI >90 1526,5 lm 127,2 lm/W 	<p>Control</p> <p>2620 _ _ / _ 1 DALI-2</p> <hr/> <p>2620 _ _ / _ 3 1-10V</p> <hr/> <p>2620 _ _ / _ Z Casambi</p>
<p>Materials</p> <p>Diffuser: Polycarbonate. Main body: Aluminum. Structures: Aluminum.</p>	<p>Packaging</p> <p>2 Boxes Total Vol 0,0356 m³ Gross weight 3,6 Kg Net weight 2,4 Kg</p>	
<p>Light Source and electronics</p> <p>2 x LED PLATE 24V 6 W Constant Voltage 24V 110~240V 50/60Hz</p>		
<p>Notes</p> <p>* Electrical connection point.</p>		
<p>UNTIL STOCK RUNS OUT</p> <p>LED IP20 CE EAC Bi-volt </p>		

Ceiling

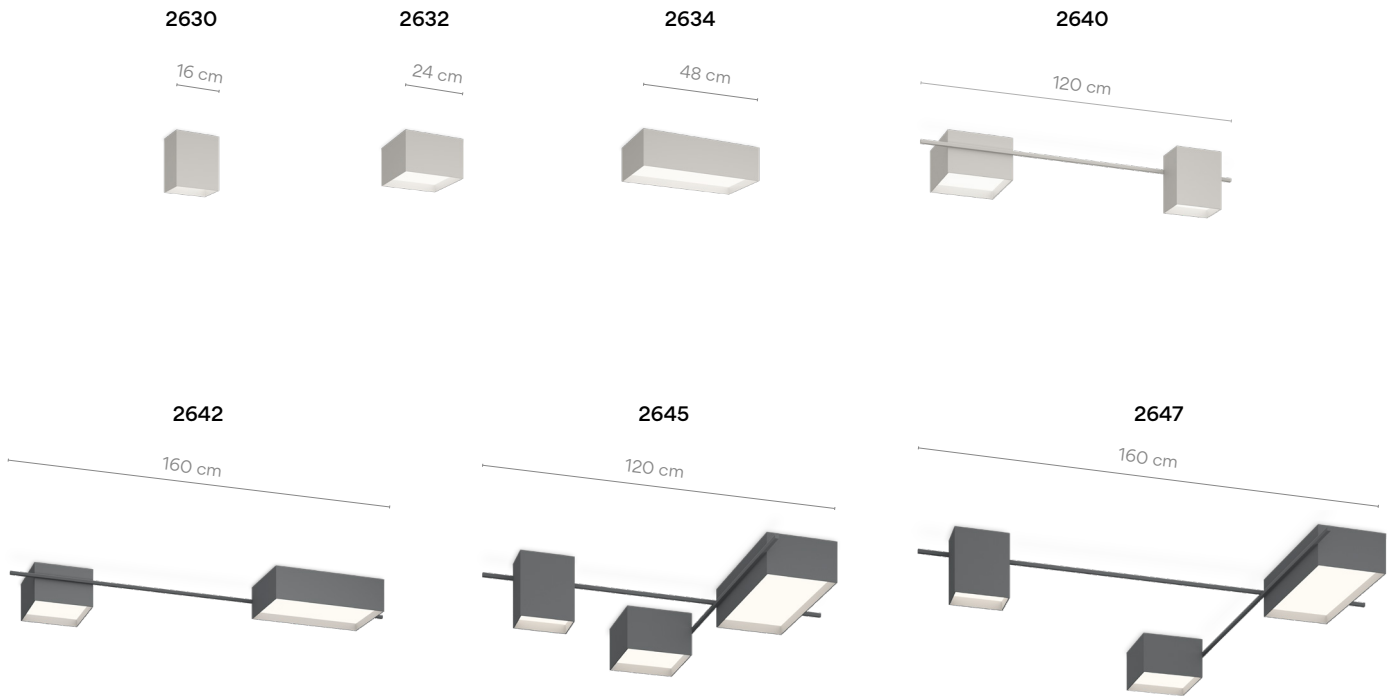

2630

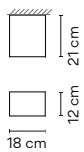

Finishes

- 21/ _ _ Black Grey (NCS S 7000-N)
- 15/ _ _ Grey L2 (NCS S 2500-N)

Finish customization
 (Available options:
 Vibia colour palette)

Materials

Diffuser: Polycarbonate. Main body: Aluminum.
 Structures: Aluminum.

Light Source and electronics

1 x LED PLATE 24V 9 W
 Constant Voltage 24V
 110-240V 50/60Hz

LED temperature colour

- /2 _ 3000 K CRI >90 1078 lm 120 lm/W
- /3 _ 3500 K CRI >90 1087,3 lm 120,8 lm/W

Control

2630 _ _ / _ 1
 DALI-2

2630 _ _ / _ 3
 1-10V

2630 _ _ / _ Z
 Casambi

Packaging

1 Box 0,4 x 0,4 x 0,2 m
 Vol 0,032 m³
 Gross weight 3,75 Kg Net weight 2,5 Kg



2632

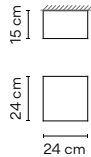

- Finishes**
- **21/** __ Black Grey (NCS S 7000-N)
 - **15/** __ Grey L2 (NCS S 2500-N)
- Finish customization**
(Available options:
Vibia colour palette)

- LED temperature colour**
- /2** _ 3000 K CRI >90 2214 lm 148 lm/W
 - /3** _ 3500 K CRI >90 2233,1 lm 148,9 lm/W

- Control**
- 2632** __ / _ 1 DALI-2
 - 2632** __ / _ 3 1-10V
 - 2632** __ / _ Z Casambi

Materials
Diffuser: Polycarbonate. Main body: Aluminum.
Structures: Aluminum.

Light Source and electronics
1 x LED PLATE 24V 15 W
Constant Voltage 24V
110-240V 50/60Hz

Packaging
1 Box 0,34 x 0,34 x 0,25 m
Vol 0,029 m³
Gross weight 4,35 Kg Net weight 2,9 Kg

2634

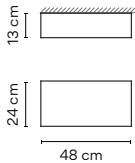

- Finishes**
- **21/** __ Black Grey (NCS S 7000-N)
 - **15/** __ Grey L2 (NCS S 2500-N)
- Finish customization**
(Available options:
Vibia colour palette)

- LED temperature colour**
- /2** _ 3000 K CRI >90 4428 lm 148 lm/W
 - /3** _ 3500 K CRI >90 4466,2 lm 148,9 lm/W

- Control**
- 2634** __ / _ 1 DALI-2
 - 2634** __ / _ 3 1-10V
 - 2634** __ / _ Z Casambi

Materials
Diffuser: Polycarbonate. Main body: Aluminum.
Structures: Aluminum.

Light Source and electronics
1 x LED PLATE 24V 30 W
Constant Voltage 24V
110-240V 50/60Hz

Packaging
1 Box 0,58 x 0,34 x 0,23 m
Vol 0,045 m³
Gross weight 5,85 Kg Net weight 3,9 Kg

2640

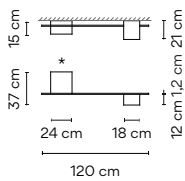

- Finishes**
- **21/** __ Black Grey (NCS S 7000-N)
 - **15/** __ Grey L2 (NCS S 2500-N)
- Finish customization**
(Available options:
Vibia colour palette)

- LED temperature colour**
- /2** _ 3000 K CRI >90 3292 lm 137 lm/W
 - /3** _ 3500 K CRI >90 3320,4 lm 138,3 lm/W

- Control**
- 2640** __ / _ 1 DALI-2
 - 2640** __ / _ 3 1-10V
 - 2640** __ / _ Z Casambi

Materials
Diffuser: Polycarbonate. Main body: Aluminum.
Structures: Aluminum.

Light Source and electronics
1 x LED PLATE 24V 9 W
1 x LED PLATE 24V 15 W
Constant Voltage 24V
110-240V 50/60Hz

Packaging
3 Boxes
Total Vol 0,15 m³
Gross weight 8,25 Kg Net weight 5,5 Kg

Notes
* Electrical connection point.

2642

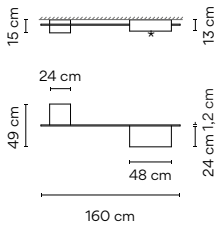

Finishes

- 21/ _ _ Black Grey (NCS S 7000-N)
- 15/ _ _ Grey L2 (NCS S 2500-N)

Finish customization
 (Available options:
 Vibia colour palette)

Materials

Diffuser: Polycarbonate. Main body: Aluminum.
 Structures: Aluminum.

Light Source and electronics

1 x LED PLATE 24V 15 W
 1 x LED PLATE 24V 30 W
 Constant Voltage 24V
 110-240V 50/60Hz

LED temperature colour

- /2 3000 K CRI >90 6642 lm 148 lm/W
- /3 3500 K CRI >90 6699,3 lm 148,9 lm/W

Control

- 2642 _ _ / _ 1 DALI-2
- 2642 _ _ / _ 3 1-10V
- 2642 _ _ / _ Z Casambi

Packaging

1 Box 0,25 x 0,60 x 1,7 m
 Vol 0,255 m³
 Gross weight 11,25 Kg Net weight 7,5 Kg

Notes

* Electrical connection point.



2645

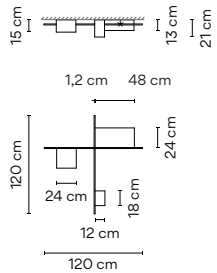

Finishes

- 21/ _ _ Black Grey (NCS S 7000-N)
- 15/ _ _ Grey L2 (NCS S 2500-N)

Finish customization
 (Available options:
 Vibia colour palette)

Materials

Diffuser: Polycarbonate. Main body: Aluminum.
 Structures: Aluminum.

Light Source and electronics

1 x LED PLATE 24V 9 W
 1 x LED PLATE 24V 15 W
 1 x LED PLATE 24V 30 W
 Constant Voltage 24V
 110-240V 50/60Hz

LED temperature colour

- /2 3000 K CRI >90 7720 lm 143 lm/W
- /3 3500 K CRI >90 7786,6 lm 144,2lm/W

Control

- 2645 _ _ / _ 1 DALI-2
- 2645 _ _ / _ 3 1-10V
- 2645 _ _ / _ Z Casambi

Packaging

1 Box 0,25 x 1,2 x 1,2 m
 Vol 0,42 m³
 Gross weight 14,25 Kg Net weight 9,25 Kg

Notes

* Electrical connection point.



2647

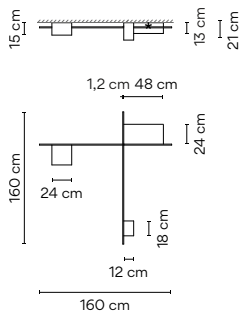

Finishes

- 21/ _ _ Black Grey (NCS S 7000-N)
- 15/ _ _ Grey L2 (NCS S 2500-N)

Finish customization
 (Available options:
 Vibia colour palette)

Materials

Diffuser: Polycarbonate. Main body: Aluminum.
 Structures: Aluminum.

Light Source and electronics

1 x LED PLATE 24V 9 W
 1 x LED PLATE 24V 15 W
 1 x LED PLATE 24V 30 W
 Constant Voltage 24V
 110-240V 50/60Hz

LED temperature colour

- /2 3000 K CRI >90 7720 lm 143 lm/W
- /3 3500 K CRI >90 7786,6 lm 144,2 lm/W

Control

- 2647 _ _ / _ 1 DALI-2
- 2647 _ _ / _ 3 1-10V
- 2647 _ _ / _ Z Casambi

Packaging

1 Box 0,25 x 1,7 x 1,7 m
 Vol 0,72 m³
 Gross weight 15,3 Kg Net weight 10,2 Kg

Notes

* Electrical connection point.



Class

Design by Sebastian Herkner

Timeless, elegant and enduring, Class brings the refined, intimate aesthetic of a patio light with the functional performance of a bollard. Rather than silently integrating into the garden environment, it stands handsome and proud, its cylindrical glass luminaire radiating with a soft, diffuse and indirect light.

Outdoor

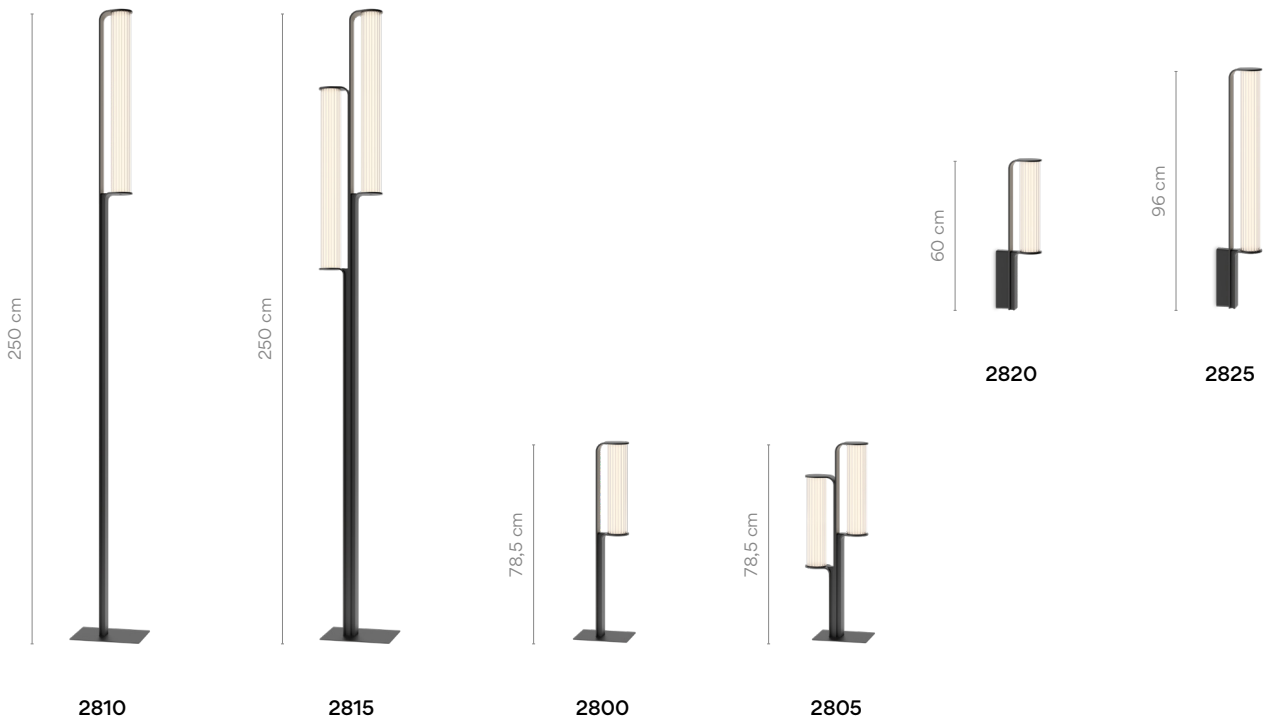

2800

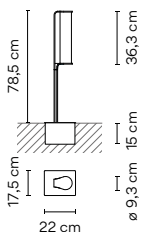

Finishes
 ● 11/ _ _ Black
 (NCS S 8500-N)

LED temperature colour
 /1 _ 2700 K 
 CRI >90 1188 lm 198 lm/W

Control
 2800 _ _ / _ 1
 DALI

2800 _ _ / _ 5
 Push

2800 _ _ / _ Z 30
 Casambi (Remote)

Materials
 Body: Aluminium. Glass: Borosilicate glass.
 Diffuser: Opal polycarbonate.

Light Source and electronics
 1 x LED 3,5W 150 mA
 Constant Current 150 mA
 220~240V. 50/60Hz

Packaging
 2 Boxes
 Box 1: 0,95 x 0,30 x 0,30 m
 Box 2: 0,31 x 0,31 x 0,21 m
 Total Vol 0,11 m³
 Gross weight 11,6 Kg Net weight 9,6 Kg

LED  IP65    

2805

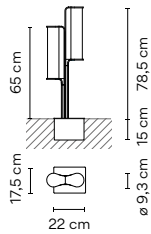

Finishes ● 11/ __ Black (NCS S 8500-N)
 LED temperature colour /1_ 2700 K CRI >90 2376 lm 198 lm/W

Control 2805 __ / _ 1 DALI
 2805 __ / _ 5 Push
 2805 __ / _ Z Casambi (Remote)

Materials Body: Aluminium. Glass: Borosilicate glass. Diffuser: Opal polycarbonate.
 Light Source and electronics 2 x LED 3,5W 150 mA Constant Current 300 mA 220~240V. 50/60Hz

Packaging 2 Boxes Box 1: 0,95 x 0,30 x 0,30 m Box 2: 0,31 x 0,31 x 0,21 m Total Vol 0,11 m³ Gross weight 14,8 Kg Net weight 12,8 Kg

2810

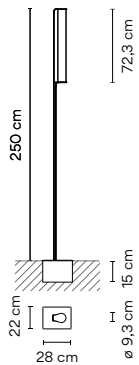

Finishes ● 11/ __ Black (NCS S 8500-N)
 LED temperature colour /1_ 2700 K CRI >90 2376 lm 198 lm/W

Control 2810 __ / _ 1 DALI
 2810 __ / _ 5 Push
 2810 __ / _ Z 30 Casambi (Remote)

Materials Body: Aluminium. Glass: Borosilicate glass. Diffuser: Opal polycarbonate.
 Light Source and electronics 1 x LED 7W 300 mA Constant Current 300 mA 220~240V. 50/60Hz

Packaging 2 Boxes Box 1: 2,92 x 0,32 x 0,32 m Box 2: 0,37 x 0,32 x 0,22 m Total Vol 0,33 m³ Gross weight 20,5 Kg Net weight 17,5 Kg

2815

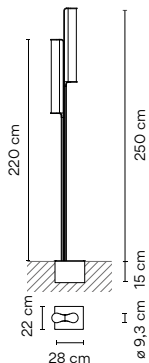

Finishes ● 11/ __ Black (NCS S 8500-N)
 LED temperature colour /1_ 2700 K CRI >90 4752 lm 198 lm/W

Control 2815 __ / _ 1 DALI
 2815 __ / _ 5 Push
 2815 __ / _ Z 30 Casambi (Remote)

Materials Body: Aluminium. Glass: Borosilicate glass. Diffuser: Opal polycarbonate.
 Light Source and electronics 2 x LED 7W 300 mA Constant Current 600 mA 220~240V. 50/60Hz

Packaging 2 Boxes Box 1: 2,92 x 0,32 x 0,32 m Box 2: 0,37 x 0,32 x 0,22 m Total Vol 0,33 m³ Gross weight 28,4 Kg Net weight 25,4 Kg

2820

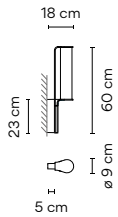

Finishes	LED temperature colour
● 11/ _ _ Black (NCS S 8500-N)	/1 _ 2700 K  CRI >90 1188 lm 198 lm/W

Control
2820 _ _ / _ 1 DALI-2

2820 _ _ / _ 5
Push

2820 _ _ / Z _ 30
Casambi (Remote)

Materials

Body: Aluminium. Glass: Borosilicate glass.
Diffuser: Opal polycarbonate.

Light Source and electronics

1 x LED 3,5W 150 mA
Constant Current 150 mA
220~240V. 50/60Hz

Packaging

1 Box 0,95 x 0,40 x 0,20 m
Vol 0,08 m³
Gross weight 4,4 Kg Net weight 2,9 Kg



2825

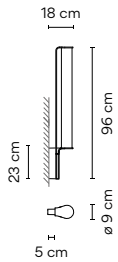

Finishes	LED temperature colour
● 11/ _ _ Black (NCS S 8500-N)	/1 _ 2700 K  CRI >90 2376 lm 198 lm/W

Control
2825 _ _ / _ 1 DALI-2

2825 _ _ / _ 5
Push

2825 _ _ / Z _ 30
Casambi (Remote)

Materials

Body: Aluminium. Glass: Borosilicate glass.
Diffuser: Opal polycarbonate.

Light Source and electronics

1 x LED 7W 300 mA
Constant Current 300 mA
220~240V. 50/60Hz

Packaging

1 Box 0,95 x 0,30 x 0,30 m
Vol 0,09 m³
Gross weight 6,4 Kg Net weight 4,40 Kg





Dama

Design by Ludovica+Roberto Palomba

Combining technical quality and refinement with a layer of warmth and intimacy, the Dama collection connects the charm of tradition with the finesse of contemporary lighting design.

Table Floor Pendants



3225

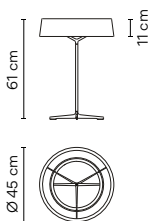

- Finishes
- 11/ _ _ Black (NCS S 8500-N)
 - 25/ _ _ Beige D1 (NCS S 4005-Y50R)

LED temperature colour
/1 _ 2700 K 
CRI >90 1850 lm 120 lm/W

Control
3225 _ _ / _ 5
Push

3225 _ _ / _ Z
Casambi

Materials
Tube: Steel. Base: Zamak.
Shade: Paper.

Light Source and electronics
1 x LED STRIP 16,2W 900 mA
Constant Voltage 24V
100~240V. 50/60Hz

Packaging
1 Box 0,75 x 0,55 x 0,55 m
Vol 0,23 m³
Gross weight 3,3 Kg Net weight 1,8 Kg

Notes
Electric cable 2,5 m

1160 10 / 1A _18

Model
Finish
LED temperature colour
Control
Electrical connection
Only for pendants

3230

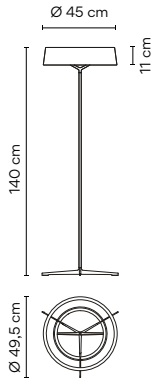

- Finishes**
- 11/ _ _ Black (NCS S 8500-N)
 - 25/ _ _ Beige D1 (NCS S 4005-Y50R)

LED temperature colour
/1_ 2700 K
CRI >90 1850 lm 120 lm/W

Control
3230 _ _ / _ 5
Push
3230 _ _ / _ Z
Casambi

Materials
Tube: Steel. Base: Zamak.
Shade: Paper.

Light Source and electronics
1 x LED STRIP 16,2W 900 mA
Constant Voltage 24V
100-240V. 50/60Hz

Packaging
1 Box 1,6 x 0,55 x 0,55 m
Vol 0,48 m³
Gross weight 5 Kg Net weight 2,55 Kg

Notes
Electric cable 2,5 m

LED IP20 CE EAC Bi-volt

3235

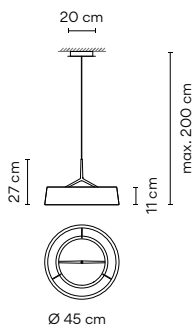

- Finishes**
- 11/ _ _ Black (NCS S 8500-N)
 - 25/ _ _ Beige D1 (NCS S 4005-Y50R)

LED temperature colour
/1_ 2700 K
CRI >90 1850 lm 120 lm/W

Control
3235 _ _ / _ 1
DALI
3235 _ _ / _ B
1-10V, Push
3235 _ _ / _ Z
Casambi

Materials
Body: Aluminium.
Shade: Paper.

Light Source and electronics
1 x LED STRIP 16,2W 900 mA
Constant Current 900 mA
110-240V. 50/60Hz

Packaging
1 Box 0,40 x 0,55 x 0,55 m
Vol 0,12 m³
Gross weight 3,2 Kg Net weight 1,6 Kg

Notes
Extra cable length.

LED IP20 CE EAC Bi-volt

Electrical connection
_18 Surface Free Wire
_23 Built-in
_31 Remote Micro for plaster ceilings
_32 Remote XXS for all types of drop ceilings



Electrical connection options for model 3235

Choose your preferred installation option according to your needs. For each composition, the optimal minimum number of drivers will be delivered.

Drop ceiling

The innovative remote and built-in fittings accentuate the silkiness and lightness of compositions on suspended ceilings, its great visual grandeur taking center stage.

For Ref. 3235

Remote

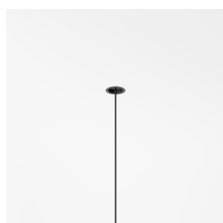

Micro \varnothing 3 cm
height 7 cm
for plaster ceilings.
Black finish.

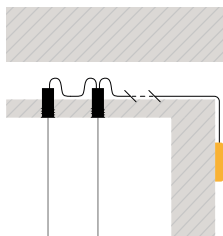

Built-in



\varnothing 8 cm
height 6 cm
match with
fixture finish.

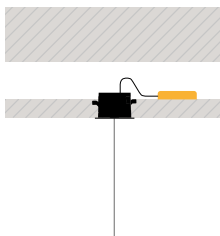

Regular ceiling

When architecture does not allow for performance, surface and free wire showcase possibilities for any need or desire with no limits, ideal for both individual or cluster arrangements.

For Ref. 3235

Surface



ø 20 cm
match with
fixture finish.

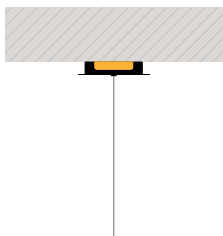

Free Wire

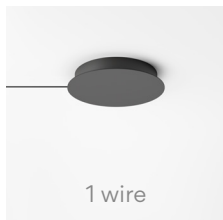

1 wire

ø 20 cm

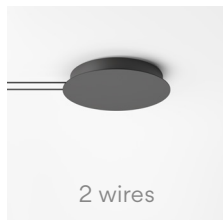

2 wires

ø 22 cm

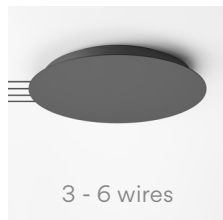

3 - 6 wires

ø 36 cm



7 - 8 wires

ø 40 cm

you can choose the finish of the canopy
among black, white or any colour
matching one of the pendants.

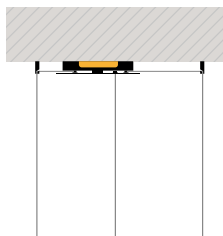

Palma

Design by Antoni Arola

The interior ambience takes on a life of its own with the possibility of integrating plants with the lighting compositions. Palma connects light and vegetation as in the natural landscape.

Wall

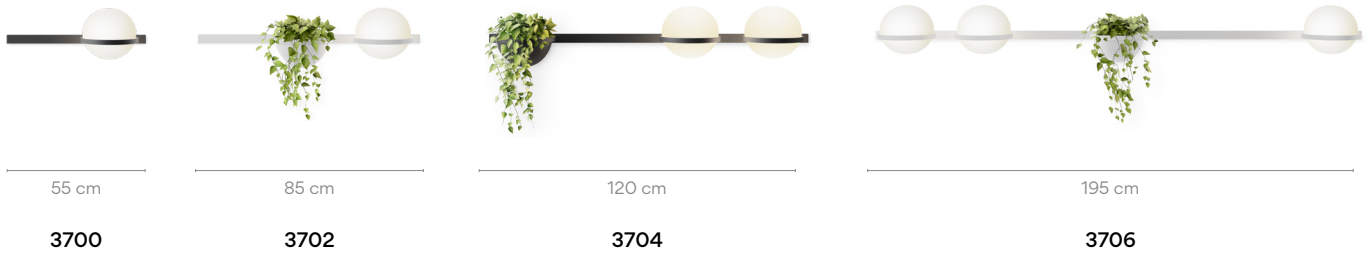

3700

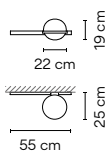

Finishes
 ● **18/** __ Graphite (ADAPTA RF 9913 WX)
 ● **93/** __ White (RAL 9016)

LED temperature colour
 /1_ 2700 K CRI >90 868 lm 94 lm/W

Control
3700 __ / __ B
 1-10V, Push

Materials
 Diffuser: Blown-glass. Profile: Aluminum.

Light Source and electronics
 2 x LED 4,6 W 500 mA
 Constant Current 500 mA
 220~240V 50/60Hz

Packaging
 1 Box 0,57 x 0,31 x 0,21 m
 Vol 0,0382 m³
 Gross weight 3 Kg Net weight 1,8 Kg

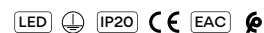

3702

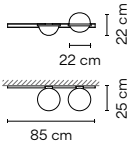

Finishes LED temperature colour Control
 ● 18/ __ Graphite /1_ 2700 K 3702 __ / _ 1
 (ADAPTA RF 9913 WX) CRI >90 868 lm 87 lm/W DALI
 ● 93/ __ White 3702 __ / _ B
 (RAL 9016) 1-10V, Push

Materials
 Diffuser: Blown-glass. Profile: Aluminum.
 Planter: PMMA.

Light Source and electronics
 2 x LED 4,6 W 500 mA
 Constant Current 500 mA
 220~240V 50/60Hz

Packaging
 1 Box 0,87 x 0,31 x 0,21 m
 Vol 0,0581 m³
 Gross weight 4,05 Kg Net weight 2,4 Kg

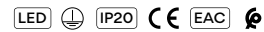

3704

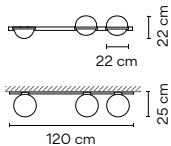

Finishes LED temperature colour Control
 ● 18/ __ Graphite /1_ 2700 K 3704 __ / _ 1
 (ADAPTA RF 9913 WX) CRI >90 1736 lm 87 lm/W DALI
 ● 93/ __ White 3704 __ / _ B
 (RAL 9016) 1-10V, Push

Materials
 Diffuser: Blown-glass. Profile: Aluminum.
 Planter: PMMA.

Light Source and electronics
 4 x LED 4,6 W 500 mA
 Constant Current 500 mA
 220~240V 50/60Hz

Packaging
 2 Boxes
 Total Vol 0,0081 m³
 Gross weight 6,2 Kg Net weight 3,9 Kg

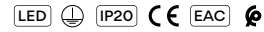

3706

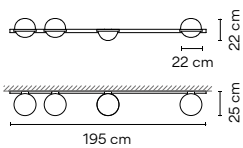

Finishes LED temperature colour Control
 ● 18/ __ Graphite /1_ 2700 K 3706 __ / _ 1
 (ADAPTA RF 9913 WX) CRI >90 2604 lm 87 lm/W DALI
 ● 93/ __ White 3706 __ / _ B
 (RAL 9016) 1-10V, Push

Materials
 Diffuser: Blown-glass. Profile: Aluminum.
 Planter: PMMA.

Light Source and electronics
 6 x LED 4,6 W 500 mA
 Constant Current 500 mA
 220~240V 50/60Hz

Packaging
 2 Boxes
 Total Vol 0,1793 m³
 Gross weight 6,4 Kg Net weight 3,9 Kg

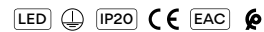

3710

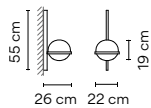

Finishes LED temperature colour Control
 ● 18/ __ Graphite /1_ 2700 K 3710 __ / _ B
 (ADAPTA RF 9913 WX) CRI >90 868 lm 87 lm/W 1-10V, Push
 ● 93/ __ White

Materials
 Diffuser: Blown-glass. Profile: Aluminum.

Light Source and electronics
 2 x LED 4,6 W 500 mA
 Constant Current 500 mA
 220~240V 50/60Hz

Packaging
 1 Box 0,57 x 0,31 x 0,21 m
 Vol 0,0382 m³
 Gross weight 2,6 Kg Net weight 1,8 Kg

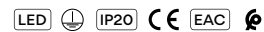

3714

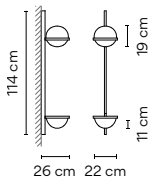

Finishes LED temperature colour
 ● 18/ __ Graphite /1_ 2700 K 
 (ADAPTA RF 9913 WX) CRI >90 868 lm 87 lm/W
 ● 93/ __ White
 (RAL 9016)

Control
 3714 __ / _ 1
 DALI
 3714 __ / _ B
 1-10V, Push

Materials
 Diffuser: Blown-glass. Profile: Aluminum.
 Planter: PMMA.

Packaging
 2 Boxes
 Total Vol 0,0081 m³
 Gross weight 5,2 Kg Net weight 2,9 Kg

Light Source and electronics
 2 x LED 4,6 W 500 mA
 Constant Current 500 mA
 220~240V 50/60Hz

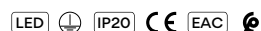

3716

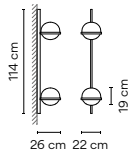

Finishes LED temperature colour
 ● 18/ __ Graphite /1_ 2700 K 
 (ADAPTA RF 9913 WX) CRI >90 1736 lm 87 lm/W
 ● 93/ __ White
 (RAL 9016)

Control
 3716 __ / _ 1
 DALI
 3716 __ / _ B
 1-10V, Push

Materials
 Diffuser: Blown-glass. Profile: Aluminum.

Packaging
 2 Boxes
 Total Vol 0,0081 m³
 Gross weight 6,5 Kg Net weight 4,2 Kg

Light Source and electronics
 4 x LED 4,6 W 500 mA
 Constant Current 500 mA
 220~240V 50/60Hz

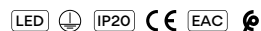

3718

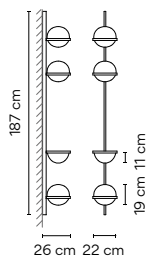

Finishes LED temperature colour
 ● 18/ __ Graphite /1_ 2700 K 
 (ADAPTA RF 9913 WX) CRI >90 2604 lm 87 lm/W
 ● 93/ __ White
 (RAL 9016)

Control
 3718 __ / _ 1
 DALI
 3718 __ / _ B
 1-10V, Push

Materials
 Diffuser: Blown-glass. Profile: Aluminum.
 Planter: PMMA.

Packaging
 2 Boxes
 Total Vol 0,1793 m³
 Gross weight 8,6 Kg Net weight 6,1 Kg

Light Source and electronics
 6 x LED 4,6 W 500 mA
 Constant Current 500 mA
 220~240V 50/60Hz

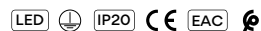

Pendants



3720

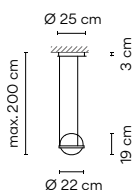

Finishes
 ● 18/ _ _ Graphite (ADAPTA RF 9913 WX)
 ● 93/ _ _ White (RAL 9016)

LED temperature colour
 /1_ 2700 K CRI >90 868 lm 87 lm/W

Control
 3720 _ _ / _ 1
 DALI

3720 _ _ / _ B
 1-10V, Push

3720 _ _ / _ Z
 Casambi

Materials
 Diffuser: Blown-glass. Profile: Aluminum.

Light Source and electronics
 2 x LED 4,6 W 500 mA
 Constant Current 500 mA
 110-240V 50/60Hz

Packaging
 1 Box 0,71 x 0,27 x 0,21 m
 Vol 0,0413 m³
 Gross weight 3,75 Kg Net weight 2,8 Kg

Notes
 Extra cable length.



3724

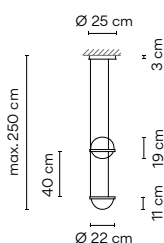

Finishes
 ● 18/ _ _ Graphite (ADAPTA RF 9913 WX)
 ● 93/ _ _ White (RAL 9016)

LED temperature colour
 /1_ 2700 K CRI >90 868 lm 87 lm/W

Control
 3724 _ _ / _ 1
 DALI

3724 _ _ / _ B
 1-10V, Push

3724 _ _ / _ Z
 Casambi

Materials
 Diffuser: Blown-glass. Profile: Aluminum.
 Planter: PMMA.

Light Source and electronics
 2 x LED 4,6 W 500 mA
 Constant Current 500 mA
 110-240V 50/60Hz

Packaging
 1 Box 1,02 x 0,27 x 0,21 m
 Vol 0,0588 m³
 Gross weight 4,6 Kg Net weight 3,3 Kg

Notes
 Extra cable length.



3726

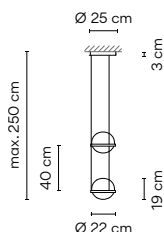

Finishes
 ● 18/ _ _ Graphite (ADAPTA RF 9913 WX)
 ● 93/ _ _ White (RAL 9016)

LED temperature colour
 /1_ 2700 K CRI >90 1736 lm 87 lm/W

Control
 3726 _ _ / _ 1
 DALI

3726 _ _ / _ B
 1-10V, Push

3726 _ _ / _ Z
 Casambi

Materials
 Diffuser: Blown-glass. Profile: Aluminum.

Light Source and electronics
 4 x LED 4,6 W 500 mA
 Constant Current 500 mA
 110-240V 50/60Hz

Packaging
 1 Box 1,02 x 0,27 x 0,21 m
 Vol 0,0588 m³
 Gross weight 5,4 Kg Net weight 4,1 Kg

Notes
 Extra cable length.



3728

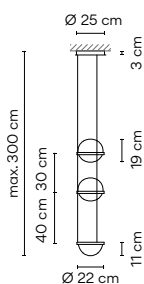

Finishes
 ● 18/ _ _ Graphite (ADAPTA RF 9913 WX)
 ● 93/ _ _ White (RAL 9016)

LED temperature colour
 /1_ 2700 K CRI >90 1736 lm 87 lm/W

Control
 3728 _ _ / _ 1
 DALI

3728 _ _ / _ B
 1-10V, Push

3728 _ _ / _ Z
 Casambi

Materials
 Diffuser: Blown-glass. Profile: Aluminum.
 Planter: PMMA.

Light Source and electronics
 4 x LED 4,6 W 500 mA
 Constant Current 500 mA
 110-240V 50/60Hz

Packaging
 1 Box 0,75 x 0,53 x 0,21 m
 Vol 0,0857 m³
 Gross weight 8,8 Kg Net weight 4,7 Kg

Notes
 Extra cable length.



3730

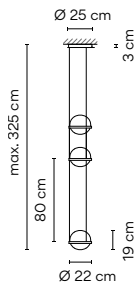

Finishes
 ● 18/ _ _ Graphite (ADAPTA RF 9913 WX)
 ● 93/ _ _ White (RAL 9016)

LED temperature colour
 /1_ 2700 K CRI >90 2604 lm 87 lm/W

Control
 3730 _ _ / _ A
 DALI, 1-10V, Push
 3730 _ _ / _ Z
 Casambi

Materials
 Diffuser: Blown-glass. Profile: Aluminum.

Light Source and electronics
 6 x LED 4,6 W 500 mA
 Constant Current 500 mA
 110-240V 50/60Hz

Packaging
 1 Box 0,75 x 0,53 x 0,21 m
 Vol 0,0857 m³
 Gross weight 9,5 Kg Net weight 5,4 Kg

Notes
 Extra cable length.



3734

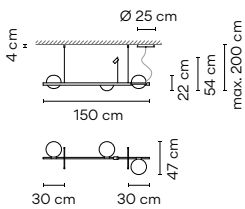

Finishes
 ● 18/ _ _ Graphite (ADAPTA RF 9913 WX)
 ● 93/ _ _ White (RAL 9016)

LED temperature colour
 /1_ 2700 K CRI >90 2265 lm 103 lm/W

Control
 3734 _ _ / _ A
 DALI, 1-10V, Push
 3734 _ _ / _ Z
 Casambi

Materials
 Diffuser: Blown-glass. Profile: Aluminum.
 Planter: PMMA.

Light Source and electronics
 1 x LED 2 W 500 mA
 4 x LED 4,6 W 500 mA
 Constant Current 500 mA
 110-240V 50/60Hz

Packaging
 1 Box 1,72 x 0,33 x 0,31 m
 Vol 0,1790 m³
 Gross weight 9,4 Kg Net weight 5,95 Kg

Notes
 Extra cable length.



3736

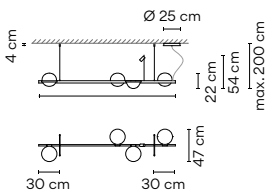

Finishes
 ● 18/ _ _ Graphite (ADAPTA RF 9913 WX)
 ● 93/ _ _ White (RAL 9016)

LED temperature colour
 /1_ 2700 K CRI >90 3133 lm 98 lm/W

Control
 3736 _ _ / _ A
 DALI, 1-10V, Push
 3736 _ _ / _ Z
 Casambi

Materials
 Diffuser: Blown-glass. Profile: Aluminum.
 Planter: PMMA.

Light Source and electronics
 1 x LED 2 W 500 mA
 6 x LED 4,6 W 500 mA
 Constant Current 500 mA
 110-240V 50/60Hz

Packaging
 2 Boxes
 Vol 0,1793 m³
 Gross weight 9,1 Kg Net weight 6,6 Kg

Notes
 Extra cable length.

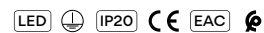

Dimmer Bi-volt

Table



ø 22 cm

3740

3740

Finishes	LED temperature colour	Control
● 18/ __ Graphite (ADAPTA RF 9913 WX)	/1_ 2700 K CRI >90 868,0 lm 94 lm/W	3740 __ / _ 5 Push
● 93/ __ White (RAL 9016)		

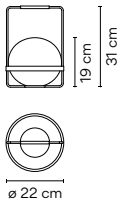

Materials
Diffuser: Blown-glass. Profile: Aluminum.
Rods: Steel.

Light Source and electronics
2 x LED 4,6 W 500 mA
Constant Current 500 mA
100~240V 50/60Hz

Packaging
1 Box 0,24 x 0,24 x 0,49 m
Vol 0,0282 m³
Gross weight 1,7 Kg Net weight 1,2 Kg

Notes
Electric cable with plug and push-button (3m).

UNTIL STOCK RUNS OUT

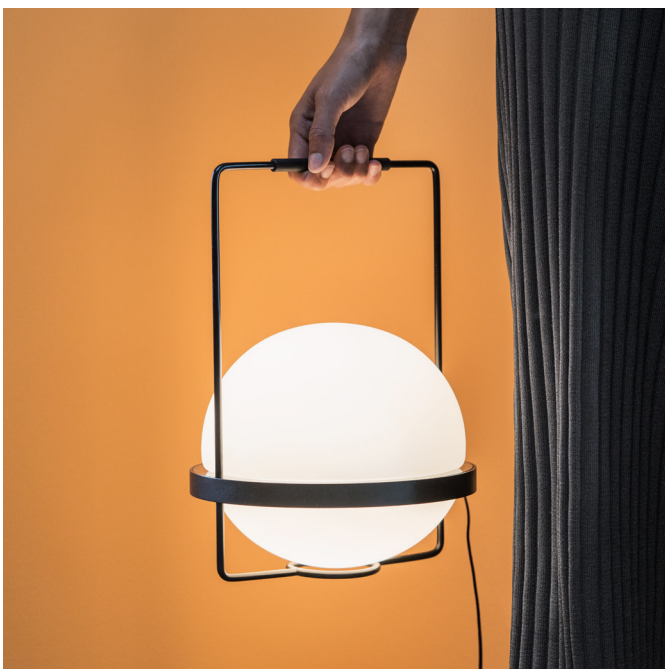



Plis Outdoor

Design by Ramos & Bassols

A surprising design which brings the warm atmosphere and textures of the indoors to the garden, terrace or porch. Breaking down boundaries between inside and outside.

Outdoor

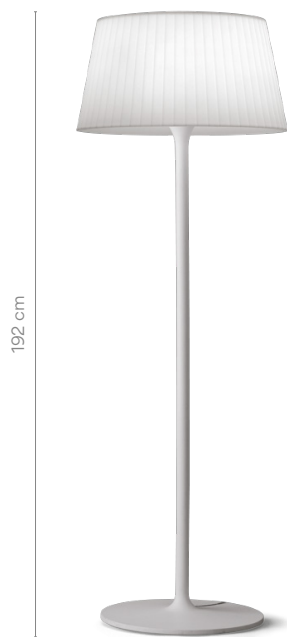

4030 4035

4030

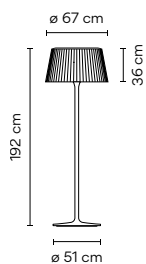

Finishes

- 03 White (RAL 9016)

LED 2700 K 1520 lm Dim

4030 03

Materials

Diffuser: Polyethylene. Base: Polyurethane foam. Lid: Steel.

Packaging

1 Box 1,99 x 0,75 x 0,76 m
Vol 1,1430 m³
Gross weight 40,5 Kg Net weight 29,5 Kg

Light Source and electronics

2 x E27 230V 12 W

Notes

Portable version. Surface cable 3,5 m

UNTIL STOCK RUNS OUT



4035

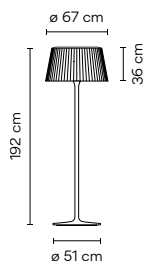

Finishes

- 03 White (RAL 9016)

LED 2700 K 1520 lm Dim

4035 03

Materials

Diffuser: Polyethylene. Base: Polyurethane foam. Lid: Steel.

Packaging

1 Box 1,99 x 0,75 x 0,76 m
Vol 1,1430 m³
Gross weight 40,5 Kg Net weight 29,5 Kg

Light Source and electronics

2 x E27 230V 12 W

Notes

Built-in cable.

UNTIL STOCK RUNS OUT



1160 10 /1A
Model Finish
LED temperature colour
Control



Wind

Design by Jordi Vilardell

A perfect marriage of technology and tradition. Wind's drum shade is made of fibreglass, an innovative webbed texture and pattern that elevates the visual contribution of this timeless silhouette.

Outdoor

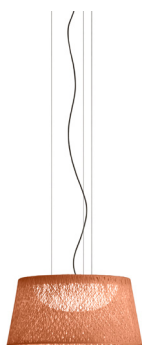

ø 60 cm

4072



ø 60 cm

4077



ø 120 cm

4078



191 cm

4057



195 cm

4062



166 cm

4067

4057

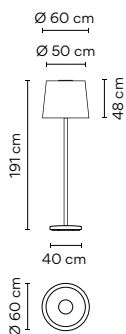

- Finishes**
- 27/ __ Brown L1 (NCS S 1505-Y50R)
 - 53/ __ Green M1 (NCS S 6005-G80Y)
 - 61/ __ Ocre red (NCS S 3050-Y60R)

LED temperature colour
/1_ 2700 K
CRI >90 3299,09 lm 132 lm/W

Control
4057 __ / __ 0
On/ Off

Materials
Shade: Filament winding. Weight: Concrete.
Lid: Steel. Diffuser: Methacrylate.

Light Source and electronics
1 x LED PLATE 25 W 700 mA
Constant Current 700 mA
110-240V 50/60Hz

Packaging
2 Boxes
Total Vol 1,0300 m³
Gross weight 45,1 Kg Net weight 27,8 Kg

Notes
Portable version. Electric cable 1,5 m



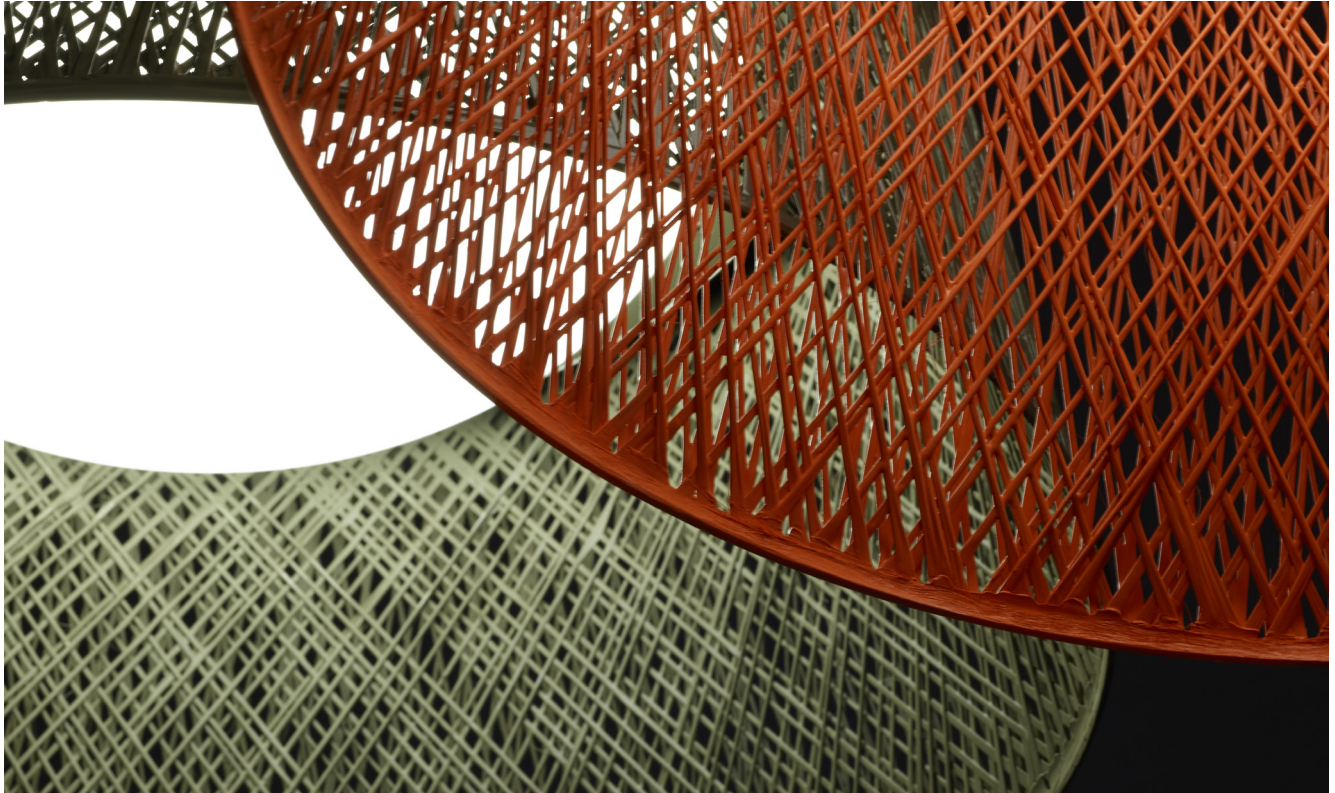

4062

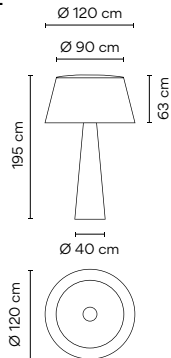

<p>Finishes</p> <ul style="list-style-type: none"> ● 27/ _ _ Brown L1 (NCS S 1505-Y50R) ● 53/ _ _ Green M1 (NCS S 6005-G80Y) ● 61/ _ _ Ocre red (NCS S 3050-Y60R) 	<p>LED temperature colour</p> <p>/1_ 2700 K CRI >90 3481,09 lm 129 lm/W</p>	<p>Control</p> <p>4062 _ _ / _ 0 On/ Off</p>
---	--	--

<p>Materials</p> <p>Base: Filament winding. Shade: Filament winding. Diffuser: Methacrylate.</p> <p>Light Source and electronics</p> <p>4 x LED 14 W 500 mA 1 x LED 2,4 W 700 mA Constant Current 700 mA 110-240V 50/60Hz</p>	<p>Packaging</p> <p>4 Boxes Total Vol 2,3500 m³ Gross weight 125,2 Kg Net weight 113,23 Kg</p> <p>Notes</p> <p>Portable version. Electric cable 2 m</p> <p> </p>
---	---

4067

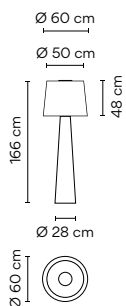

<p>Finishes</p> <ul style="list-style-type: none"> ● 27/ _ _ Brown L1 (NCS S 1505-Y50R) ● 53/ _ _ Green M1 (NCS S 6005-G80Y) ● 61/ _ _ Ocre red (NCS S 3050-Y60R) 	<p>LED temperature colour</p> <p>/1_ 2700 K CRI >90 3481,09 lm 129 lm/W</p>	<p>Control</p> <p>4067 _ _ / _ 0 On/ Off</p>
---	--	--

<p>Materials</p> <p>Shade: Filament Winding. Base: Filament Winding. Diffuser: Methacrylate.</p> <p>Light Source and electronics</p> <p>1 x LED PLATE 25 W 700 mA 1 x LED 2,4 W 700 mA Constant Current 700 mA 110-240V 50/60Hz</p>	<p>Packaging</p> <p>3 Boxes Total Vol 1,5000 m³ Gross weight 50 Kg Net weight 30,5 Kg</p> <p>Notes</p> <p>Portable version. Electric cable 1,5 m</p> <p> </p>
---	--

4072

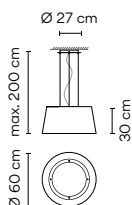

Finishes	LED temperature colour	Control
<ul style="list-style-type: none"> ● 27/ _ _ Brown L1 (NCS S 1505-Y50R) ● 53/ _ _ Green M1 (NCS S 6005-G80Y) ● 61/ _ _ Ocre red (NCS S 3050-Y60R) 	/1_ 2700 K CRI >90 3299,09 lm 132 lm/W	4072 _ _ / _ 0 On/ Off

Materials	Packaging
Shade: Filament winding. Canopy Plate: Steel. Lid: Steel. Diffuser: Methacrylate.	1 Box 0,50 x 0,77 x 0,77 m Vol 0,2970 m ³ Gross weight 11,1 Kg Net weight 9,9 Kg
Light Source and electronics	Notes
1 x LED PLATE 25 W 700 mA Constant Current 700 mA 110-240V 50/60Hz	Surface mounted Extra cable length.



4077

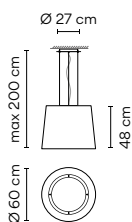

Finishes	LED temperature colour	Control
<ul style="list-style-type: none"> ● 27/ _ _ Brown L1 (NCS S 1505-Y50R) ● 53/ _ _ Green M1 (NCS S 6005-G80Y) ● 61/ _ _ Ocre red (NCS S 3050-Y60R) 	/1_ 2700 K CRI >90 3299,09 lm 132 lm/W	4077 _ _ / _ 0 On/ Off

Materials	Packaging
Shade: Filament winding. Canopy Plate: Steel. Lid: Steel. Diffuser: Methacrylate.	1 Box 0,67 x 0,67 x 0,62 m Vol 0,2970 m ³ Gross weight 11 Kg Net weight 9,9 Kg
Light Source and electronics	Notes
1 x LED PLATE 25 W 700 mA Constant Current 700 mA 110-240V 50/60Hz	Surface mounted Extra cable length.



4078

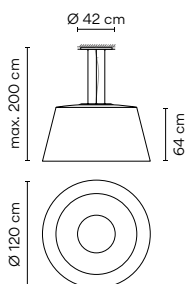

Finishes	LED temperature colour	Control
<ul style="list-style-type: none"> ● 27/ _ _ Brown L1 (NCS S 1505-Y50R) ● 53/ _ _ Green M1 (NCS S 6005-G80Y) ● 61/ _ _ Ocre red (NCS S 3050-Y60R) 	/1_ 2700 K CRI >90 3299,09 lm 132 lm/W	4078 _ _ / _ 0 On/ Off

Materials	Packaging
Shade: Filament winding. Canopy Plate: Steel. Lid: Steel. Diffuser: Methacrylate.	1 Box 0,74 x 1,24 x 1,27 m Vol 1,1300 m ³ Gross weight 38 Kg Net weight 30 Kg
Light Source and electronics	Notes
3 x LED PLATE 25 W 700 mA Constant Current 700 mA 110-240V 50/60Hz	Indoor only Extra cable length.



1160 10 /1A
Model Finish
LED temperature colour
Control



Break

Design by Xuclà & Alemany

Resembling an avant-garde sculpture, Break is distinguished by its architectural attitude. The cubic volumes angle provides down light, while doubling as sculptural outdoor presence.

Outdoor

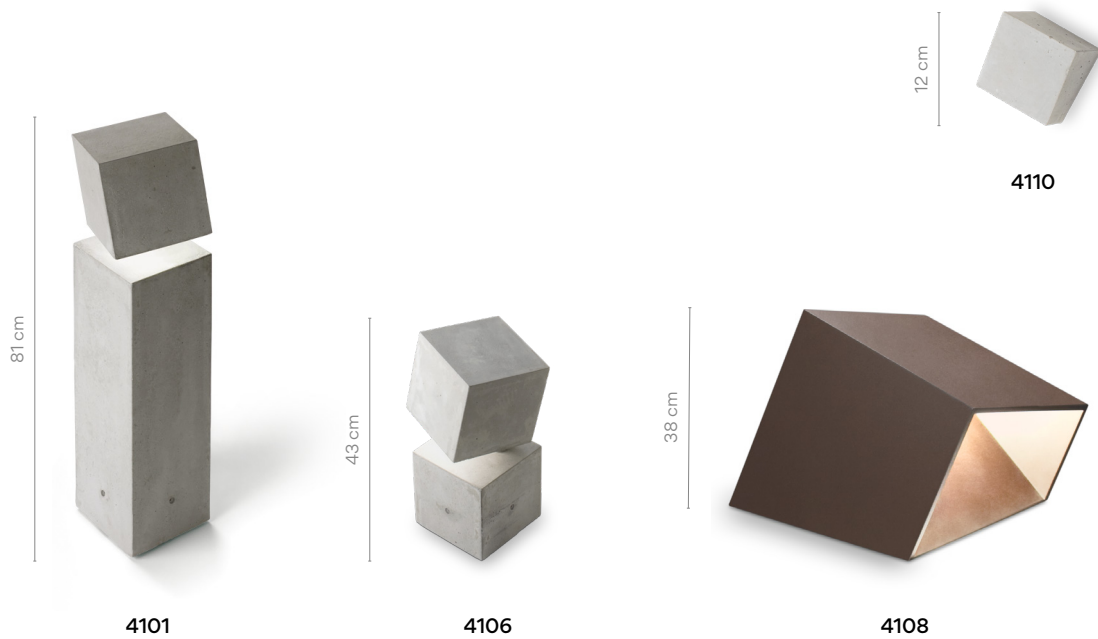

4101

<p>Finishes</p> <ul style="list-style-type: none"> ● 80/ _ _ Concrete (Natural finish) 	<p>LED temperature colour</p> <p>/1_ 2700 K CRI >80 710 lm 115 lm/W</p>	<p>Control</p> <p>4101_ _ / _ 0 On/ Off</p>
<hr/>		
<p>Materials</p> <p>Head: Concrete. Base: Concrete. Diffuser: Methacrylate.</p>	<p>Packaging</p> <p>1 Box 0,88 x 0,35 x 0,34 m Vol 0,1032 m³ Gross weight 38,9 Kg Net weight 35,01 Kg</p>	
<p>Light Source and electronics</p> <p>1 x LED 6,2 W 350 mA Constant Current 350 mA 100~240V 50/60Hz</p>	<p> </p>	

4106

<p>Finishes</p> <ul style="list-style-type: none"> ● 80/ _ _ Concrete (Natural finish) 	<p>LED temperature colour</p> <p>/1_ 2700 K CRI >80 710 lm 118 lm/W</p>	<p>Control</p> <p>4106_ _ / _ 0 On/ Off</p>
<hr/>		
<p>Materials</p> <p>Head: Concrete. Base: Concrete. Diffuser: Methacrylate.</p>	<p>Packaging</p> <p>1 Box 0,88 x 0,35 x 0,34 m Vol 0,0598 m³ Gross weight 21,5 Kg Net weight 19,35 Kg</p>	
<p>Light Source and electronics</p> <p>1 x LED 6,2 W 350 mA Constant Current 350 mA 100~240V 50/60Hz</p>	<p> </p>	

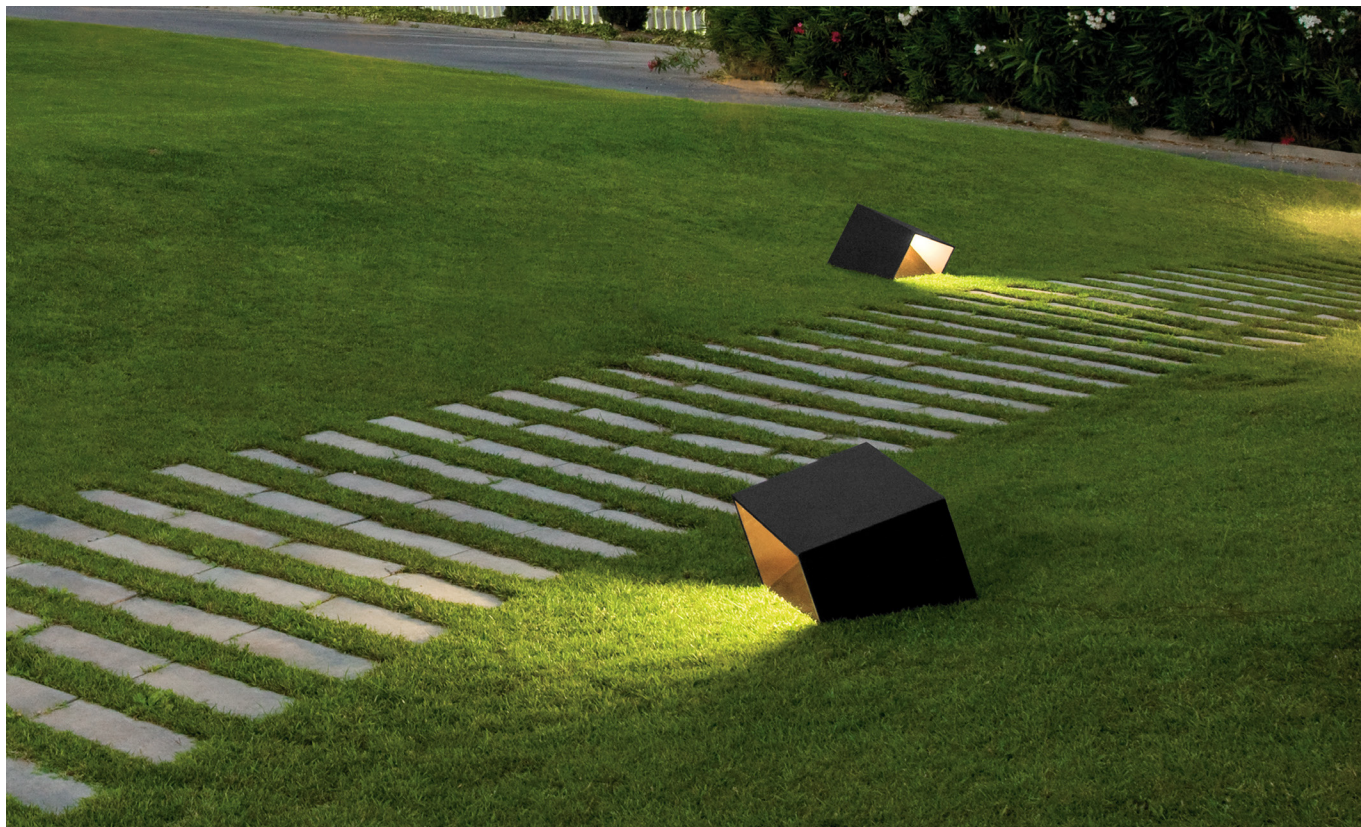

4108

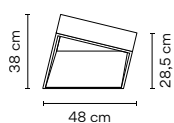

- Finishes
- 07/ _ _ Khaki (RAL 7006)
 - 54/ _ _ Oxide (RAL 8014)

LED colour temperature
 /1_ 2700 K
 CRI >80 2500 lm 118 lm/W

Control
 4108 _ _ / _ 0
 On/ Off

Materials
 Body: Steel.
 Diffuser: Methacrylate.

Light Source and electronics
 2 x LED Strip 9,2 W 400 mA
 Constant Current 400 mA
 220~240V 50/60Hz

Packaging
 1 Box 0,49 x 0,51 x 0,52 m
 Vol 0,1312 m³
 Gross weight 6,6 Kg Net weight 16 Kg

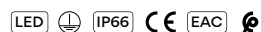

4110

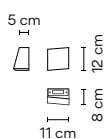

- Finishes
- 80/ _ _ Concrete (Natural finish)

LED temperature colour
 /1_ 2700 K
 CRI >80 199 lm 95 lm/W

Control
 4110 _ _ / _ 0
 On/ Off

Materials
 Body: Aluminum / Concrete.
 Diffuser: Methacrylate.

Light Source and electronics
 1 x LED 2,1 W 700 mA
 Constant Current 700 mA
 100~240V 50/60Hz

Packaging
 1 Box 0,260 x 0,260 x 0,260 m
 Vol 1,0000 m³
 Gross weight 2,30 Kg Net weight 2,07 Kg

Notes
UNTIL STOCK RUNS OUT

Break Plus

Design by Xuclà

An extension of the existing Break collection, defined by an instinctual connection to the landscape and surrounding architecture, Break Plus converts any wall into a three dimensional mural, casting diffuse, indirect light upwards, downwards or in both directions.

Outdoor

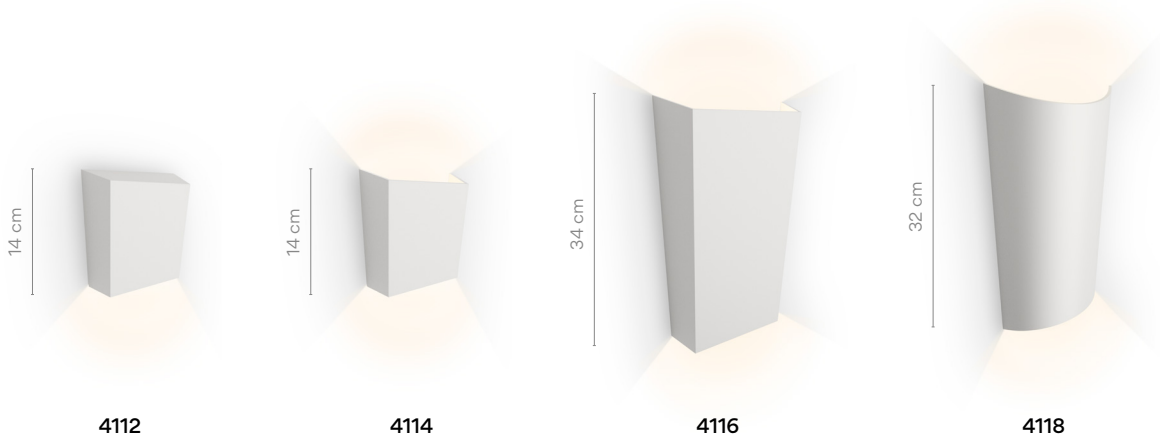

4112

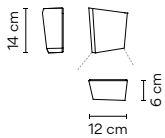

<p>Finishes</p> <ul style="list-style-type: none"> ● 22/ __ Graphite Black (NCS S 8000-N) ● 25/ __ Beige D1 (NCS S 4005-Y50R) ● 37/ __ Terra Red (NCS S 4040-Y70R) ● 95/ __ Primer (RAL 9016) 	<p>LED temperature colour</p> <p>/1 _ 2700 K CRI >90 113,73 lm 113,73 lm/W</p> <p>/3 _ 3500 K CRI >90 146,22 lm 146,22 lm/W</p>	<p>Control</p> <p>4112 _ / _ 0 On/ Off</p> <hr/> <p>4112 _ / _ 1 _ 30 DALI (Remote)</p> <hr/> <p>4112 _ / _ Z _ 30 Casambi (Remote)</p>
<p>Materials</p> <p>Body: Aluminium. Diffuser: Polycarbonate.</p> <p>Light Source and electronics</p> <p>1 x LED 1W 350 mA Constant Current 350 mA 100~240Vac. 50/60Hz</p>	<p>Packaging</p> <p>1 Box 0,07 x 0,19 x 0,23 m Vol 0,0030 m³ Gross weight 1 Kg Net weight 0,610 Kg</p>	<p> </p>

4114

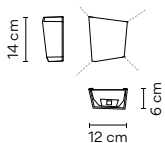

<p>Finishes</p> <ul style="list-style-type: none"> ● 22/ __ Graphite Black (NCS S 8000-N) ● 25/ __ Beige D1 (NCS S 4005-Y50R) ● 37/ __ Terra Red (NCS S 4040-Y70R) ● 95/ __ Primer (RAL 9016) 	<p>LED temperature colour</p> <p>/1 _ 2700 K CRI >90 227,46 lm 113,73 lm/W</p> <p>/3 _ 3500 K CRI >90 292,44 lm 146,22 lm/W</p>	<p>Control</p> <p>4114 _ / _ 0 On/ Off</p> <hr/> <p>4114 _ / _ 1 _ 30 DALI (Remote)</p> <hr/> <p>4114 _ / _ Z _ 30 Casambi (Remote)</p>
<p>Materials</p> <p>Body: Aluminium. Diffuser: Polycarbonate.</p> <p>Light Source and electronics</p> <p>2 x LED 1W 350 mA Constant Current 350 mA 100~240Vac. 50/60Hz</p>	<p>Packaging</p> <p>1 Box 0,07 x 0,19 x 0,23 m Vol 0,0030 m³ Gross weight 1 Kg Net weight 0,590 Kg</p>	<p> </p>



4116

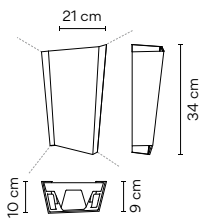

<p>Finishes</p> <ul style="list-style-type: none"> ● 22/ _ _ Graphite Black (NCS S 8000-N) ● 25/ _ _ Beige D1 (NCS S 4005-Y50R) ● 37/ _ _ Terra Red (NCS S 4040-Y70R) ● 95/ _ _ Primer (RAL 9016) 	<p>LED temperature colour</p> <ul style="list-style-type: none"> /1 _ 2700 K CRI >90 707,52 lm 90,7 lm/W /3 _ 3500 K CRI >90 925,22 lm 118,61 lm/W 	<p>Control</p> <p>4116 _ _ / _ 0 On/ Off</p> <hr/> <p>4116 _ _ / _ 1 _ 30 DALI (Remote)</p> <hr/> <p>4116 _ _ / _ Z _ 30 Casambi (Remote)</p>
<p>Materials</p> <p>Body: Aluminium. Diffuser: Polycarbonate.</p>		<p>Packaging</p> <p>1 Box 0,11 x 0,27 x 0,42 m Vol 0,0120 m³ Gross weight 3,2 Kg Net weight 2,2 Kg</p>
<p>Light Source and electronics</p> <p>2 x LED 4W 350 mA Constant Current 350 mA 100~240Vac. 50/60Hz</p>		<p> </p>

4118

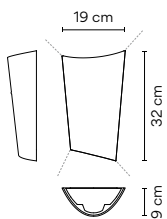

<p>Finishes</p> <ul style="list-style-type: none"> ● 22/ _ _ Graphite Black (NCS S 8000-N) ● 25/ _ _ Beige D1 (NCS S 4005-Y50R) ● 37/ _ _ Terra Red (NCS S 4040-Y70R) ● 95/ _ _ Primer (RAL 9016) 	<p>LED temperature colour</p> <ul style="list-style-type: none"> /1 _ 2700 K CRI >90 707,52 lm 90,7 lm/W /3 _ 3500 K CRI >90 925,22 lm 118,61 lm/W 	<p>Control</p> <p>4118 _ _ / _ 0 On/ Off</p> <hr/> <p>4118 _ _ / _ 1 _ 30 DALI (Remote)</p> <hr/> <p>4118 _ _ / _ Z _ 30 Casambi (Remote)</p>
<p>Materials</p> <p>Body: Aluminium. Diffuser: Polycarbonate.</p>		<p>Packaging</p> <p>1 Box 0,11 x 0,27 x 0,42 m Vol 0,0120 m³ Gross weight 3,2 Kg Net weight 1,71 Kg</p>
<p>Light Source and electronics</p> <p>2 x LED 4W 350 mA Constant Current 350 mA 100~240Vac. 50/60Hz</p>		<p> </p>

Empty

Design by Xuclà

A sculpture by day and lighting by night, this outdoor fixture embodies multifunctional design. Its crisp angles create a cantilevered perch that serves as a side table or stool.

Outdoor



4125

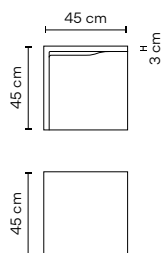

Finishes	LED temperature colour
● 18/ __ Polymer Concrete Grey (NCS S 2002-B50G)	/1 _ 2700 K CRI >80 664 lm 39 lm/W
	/3 _ 3500 K CRI >90 1247 lm 72,5 lm/W

Control
4125 __ / _ 0
On/ Off

Materials

Body: Polymer concrete.
Diffuser: Methacrylate.

Light Source and electronics

2 x LED STRIP 24V 8,6 W
Constant Voltage 24V
100~277V 50/60Hz

Packaging

1 Box 0,56 x 0,50 x 0,50 m
Vol 0,176 m³
Gross weight 40 Kg Net weight 36 Kg

Notes

Resistance to weight: 150 kg evenly distributed over the cantilevered surface of the lamp. This force should not be applied by impact.



4130

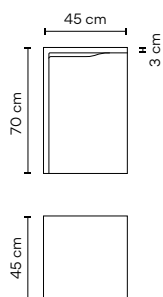

Finishes	LED temperature colour
● 18/ __ Polymer Concrete Grey (NCS S 2002-B50G)	/1 _ 2700 K CRI >80 664 lm 39 lm/W
	/3 _ 3500 K CRI >90 1247 lm 72,5 lm/W

Control
4130 __ / _ 0
On/ Off

Materials

Body: Polymer concrete.
Diffuser: Methacrylate.

Light Source and electronics

2 x LED STRIP 24V 8,6 W
Constant Voltage 24V
100~277V 50/60Hz

Packaging

1 Box 0,56 x 0,56 x 0,81 m
Vol 0,254 m³
Gross weight 54,7 Kg Net weight 49,7 Kg

Notes

Resistance to weight: 150 kg evenly distributed over the cantilevered surface of the lamp. This force should not be applied by impact.





4135

Finishes	LED temperature colour	Control
● 18/ __ Polymer Concrete Grey (NCS S 2002-B50G)	/1_ 2700 K CRI >80 304 lm 35 lm/W /3_ 3500 K CRI >90 1247 lm 145 lm/W	4135 __ / _ 0 On/ Off

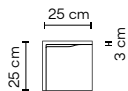

Materials

Body: Polymer concrete.
Diffuser: Methacrylate.

Light Source and electronics

2 x LED STRIP 24V 4,3 W
Constant Voltage 24V
100-240V 50/60Hz

Packaging

1 Box 0,36 x 0,36 x 0,36 m
Vol 0,04 m³
Gross weight 12,2 Kg Net weight 10,4 Kg

Notes

Resistance to weight: 150 kg evenly distributed over the cantilevered surface of the lamp. This force should not be applied by impact.



4136

Finishes	LED temperature colour	Control
● 18/ __ Polymer Concrete Grey (NCS S 2002-B50G)	/1_ 2700 K CRI >80 304 lm 35 lm/W /3_ 3500 K CRI >90 1247 lm 145 lm/W	4136 __ / _ 0 On/ Off

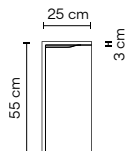

Materials

Body: Polymer concrete.
Diffuser: Methacrylate.

Light Source and electronics

2 x LED STRIP 24V 4,3 W
Constant Voltage 24V
100-240V 50/60Hz

Packaging

1 Box 0,36 x 0,36 x 0,65 m
Vol 0,084 m³
Gross weight 22 Kg Net weight 19 Kg

Notes

Resistance to weight: 150 kg evenly distributed over the cantilevered surface of the lamp. This force should not be applied by impact.



Fold Surface

Design by Arik Levy

Fold features a geometric design that creates a striking three-dimensional illumination effect. Light and shadow are projected from its cubic shapes, washing the wall with glowing chevron patterns.

Wall

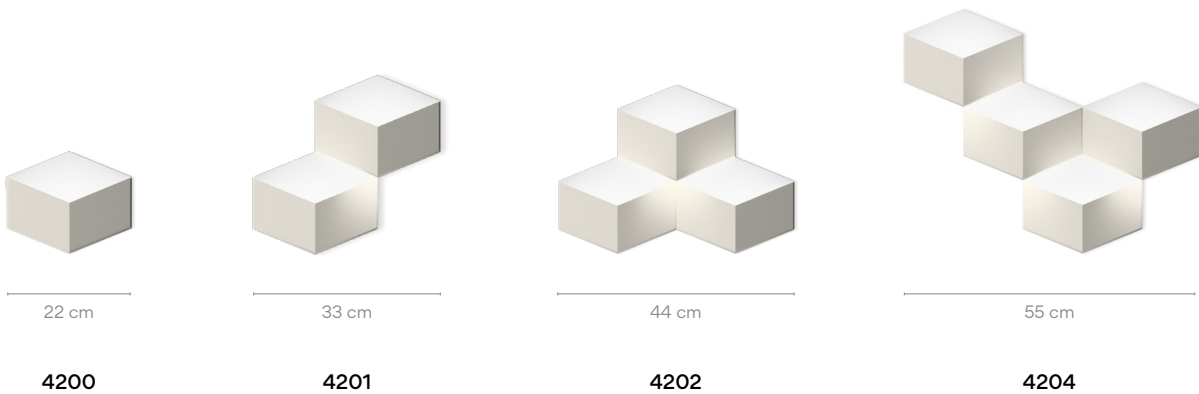

4200

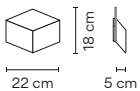

- Finishes**
- 07/ __ Green (PANTONE 385)
 - 14/ __ Chocolate (RAL 8019)
 - 58/ __ Off-white (RAL D2 1109005)

LED temperature colour
/1 _ 2700 K 
CRI >90 362,4 lm 86 lm/W

Control
4200 __ / _ 0
On/ Off

Materials
Shade: Aluminum. Body: Aluminum.
Diffuser: Polycarbonate.

Light Source and electronics
2 x LED 2,1 W 700 mA
Constant Current 700 mA
100~240V 50/60Hz

Packaging
1 Box 0,26 x 0,26 x 0,16 m
Vol 0,0116 m³
Gross weight 1,3 Kg Net weight 0,8 Kg

Notes
UNTIL STOCK RUNS OUT



4201

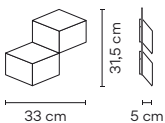

- Finishes**
- 07/ __ Green (PANTONE 385)
 - 14/ __ Chocolate (RAL 8019)
 - 58/ __ Off-white (RAL D2 1109005)

LED temperature colour
/1 _ 2700 K 
CRI >90 724,9 lm 86 lm/W

Control
4201 __ / _ 0
On/ Off

Materials
Shade: Aluminum. Body: Aluminum.
Diffuser: Polycarbonate.

Light Source and electronics
4 x LED 2,1 W 700 mA
Constant Current 700 mA
100~240V 50/60Hz

Packaging
1 Box 0,41 x 0,41 x 0,21 m
Vol 0,0353 m³
Gross weight 2,8 Kg Net weight 1,6 Kg

Notes
UNTIL STOCK RUNS OUT





4202

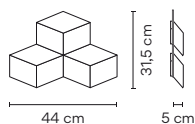

- Finishes
- 07/ _ _ Green (PANTONE 385)
 - 14/ _ _ Chocolate (RAL 8019)
 - 58/ _ _ Off-white (RAL D2 1109005)

LED temperature colour
 /1 _ 2700 K
 CRI >90 1087,3 lm 86 lm/W

Control
 4202 _ _ / _ 0
 On/ Off

Materials
 Shade: Aluminum. Body: Aluminum.
 Diffuser: Polycarbonate.

Light Source and electronics
 6 x LED 2,1 W 700 mA
 Constant Current 700 mA
 100~240V 50/60Hz

Packaging
 1 Box 0,17 x 0,51 x 0,51 m
 Vol 0,0429 m³
 Gross weight 4,2 Kg Net weight 2,4 Kg

Notes
UNTIL STOCK RUNS OUT



4204

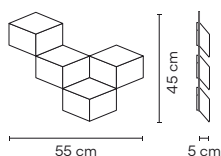

- Finishes
- 07/ _ _ Green (PANTONE 385)
 - 14/ _ _ Chocolate (RAL 8019)
 - 58/ _ _ Off-white (RAL D2 1109005)

LED temperature colour
 /1 _ 2700 K
 CRI >90 1449,8 lm 86 lm/W

Control
 4204 _ _ / _ 0
 On/ Off

Materials
 Shade: Aluminum. Body: Aluminum.
 Diffuser: Polycarbonate.

Light Source and electronics
 8 x LED 2,1 W 700 mA
 Constant Current 700 mA
 100~240V 50/60Hz

Packaging
 1 Box 0,27 x 0,60 x 0,60 m
 Vol 0,0972 m³
 Gross weight 5,7 Kg Net weight 3,2 Kg

Notes
UNTIL STOCK RUNS OUT



Out

Design by Víctor Carrasco

A romantic response to the global transition to life outside, Out brings the intimacy of indoor lighting outdoors. Suitable for illuminating a table or meeting point, this luminaire emanates with a soft, diffuse downlight, its source obscured by a translucent screen.

Floor



4270

Finishes

- 22/ __ Graphite Black (NCS S 8000N)
- 23/ __ Warm White (NCS S 0502-Y50R)
- 25/ __ Beige D1 (NCS S 4005-Y50R)
- 36/ __ Soft Pink (NCS S 1010-Y50R)
- 37/ __ Terra Red (NCS S 4040-Y70R)
- 47/ __ Green L1 (NCS S 4005-G80Y)

LED temperature colour

/1 _ 2700 K 
CRI >90 1300 lm 104,83 lm/W

Control

4270 __ / _ 5
Push
4270 __ / _ Z
Casambi

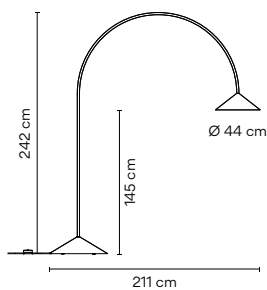

Materials

Tube: Stainless Steel. Shades: Aluminium.
Diffuser: Polyethylene.

Light Source and electronics

1 x LED 12,4W 700 mA
Constant Voltage 24V 1.0A
220-240V. 50/60Hz

Packaging

5 Boxes
Box 1: 0,17 x 0,39 x 0,51 m
Box 2: 0,17 x 0,39 x 0,51 m
Box 3: 0,60 x 0,60 x 0,27 m
Box 4: 0,72 x 0,72 x 0,32 m
Box 5: 2,40 x 2,10 x 0,1 m
Total Vol 0,835 m³
Gross weight 59 Kg Net weight 48 Kg

Notes

Surface cable 4 m





4275

- Finishes**
- **22/** __ Graphite Black (NCS S 8000N)
 - **23/** __ Warm White (NCS S 0502-Y50R)
 - **25/** __ Beige D1 (NCS S 4005-Y50R)
 - **36/** __ Soft Pink (NCS S 1010-Y50R)
 - **37/** __ Terra Red (NCS S 4040-Y70R)
 - **47/** __ Green L1 (NCS S 4005-G80Y)

LED temperature colour
 /1_ 2700 K 
 CRI >90 1300 lm 104,83 lm/W

Control
 4275 __ / _ 1
 DALI
 4275 __ / _ Z
 Casambi (Remote)

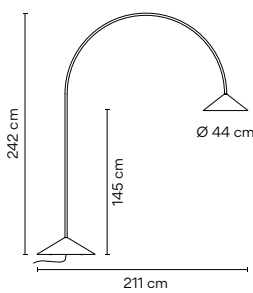

Materials
 Tube: Stainless Steel. Shades: Aluminium.
 Diffuser: Poliethylene.

Light Source and electronics
 1 x LED 12,4W 700 mA
 Constant Current 700 mA
 220~240V. 50/60Hz

Packaging
 5 Boxes
 Box 1: 0,17 x 0,39 x 0,51 m
 Box 2: 0,17 x 0,39 x 0,51 m
 Box 3: 0,60 x 0,60 x 0,27 m
 Box 4: 0,72 x 0,72 x 0,32 m
 Box 5: 2,40 x 2,10 x 0,1 m
 Total Vol 0,835 m³
 Gross weight 59 Kg Net weight 48 Kg

Notes
 Bolt-down "hard wired"



Up

Design by Ramos & Bassols

Inspired by the look of neoclassical cornices, Up blends seamlessly into the ceiling. With its flat LED diffusion system and refined rim, it gives the appearance of uniform light passing from an opening in the ceiling through a sleek frame.

Ceiling



4440

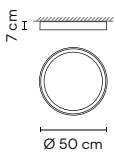

- Finishes**
- 18/ _ _ Graphite (RAL 7016)
 - 93/ _ _ White (RAL 9016)

Finish customization
(Available options:
Vibia colour palette)

Materials

Diffuser: Polycarbonate. Body: Aluminum.
Ceiling support: Steel.

Light Source and electronics

1 x LED PLATE 26,5 W 700 mA
Constant Current 700 mA
110-240V 50/60Hz

LED temperature colour

- /1 _ 2700 K CRI >90 2207 lm 98 lm/W
- /4 _ 4000 K CRI >90 2982 lm 132,5 lm/W

Control

- 4440 _ _ / _ A
DALI-2, 1-10V, Push
- 4440 _ _ / _ Z
Casambi

Packaging

1 Box 0,17 x 0,55 x 0,55 m
Vol 0,0514 m³
Gross weight 11 Kg Net weight 7,5 Kg

4442

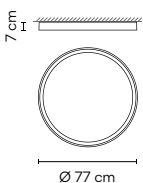

- Finishes**
- 18/ _ _ Graphite (RAL 7016)
 - 93/ _ _ White (RAL 9016)

Finish customization
(Available options:
Vibia colour palette)

Materials

Diffuser: Polycarbonate. Body: Aluminum.
Ceiling support: Steel.

Light Source and electronics

1 x LED PLATE 55,3 W 700 mA
Constant Current 700 mA
110-240V 50/60Hz

LED temperature colour

- /1 _ 2700 K CRI >90 3959 lm 100 lm/W
- /4 _ 4000 K CRI >90 6159 lm 155,8 lm/W

Control

- 4442 _ _ / _ A
DALI-2, 1-10V, Push
- 4442 _ _ / _ Z
Casambi

Packaging

1 Box 0,17 x 0,90 x 0,90 m
Vol 0,1377 m³
Gross weight 13 Kg Net weight 15 Kg

4452

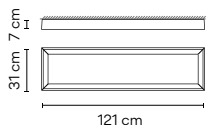

Finishes	LED temperature colour
● 18/ __ Graphite (RAL 7016)	/1 _ 2700 K CRI >90 3957 lm 79 lm/W
● 93/ __ White (RAL 9016)	/4 _ 4000 K CRI >90 4754 lm 95,1 lm/W

Finish customization
 (Available options:
 Vibia colour palette)

Control
4452 __ / _ A DALI-2, 1-10V, Push
4452 __ / _ Z Casambi

Materials
 Diffuser: Polycarbonate. Body: Aluminum.
 Ceiling support: Steel.

Light Source and electronics
 1 x LED PLATE 50 W 900 mA
 Constant Current 900 mA
 110-240V 50/60Hz

Packaging
 1 Box 0,17 x 0,42 x 1,31 m
 Vol 0,0924 m³
 Gross weight 14 Kg Net weight 12 Kg



4454

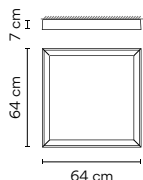

Finishes	LED temperature colour
● 18/ __ Graphite (RAL 7016)	/1 _ 2700 K CRI >90 3957 lm 79 lm/W
● 93/ __ White (RAL 9016)	/4 _ 4000 K CRI >90 4754 lm 95,1 lm/W

Finish customization
 (Available options:
 Vibia colour palette)

Control
4454 __ / _ A DALI-2, 1-10V, Push
4454 __ / _ Z Casambi

Materials
 Diffuser: Polycarbonate. Body: Aluminum.
 Ceiling support: Steel.

Light Source and electronics
 1 x LED PLATE 50 W 900 mA
 Constant Current 900 mA
 110-240V 50/60Hz

Packaging
 1 Box 0,17 x 0,73 x 0,73 m
 Vol 0,0905 m³
 Gross weight 14 Kg Net weight 13 Kg



4460

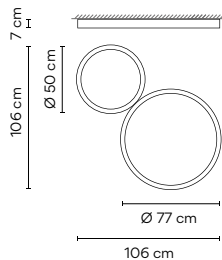

Finishes	LED temperature colour
● 18/ __ Graphite (RAL 7016)	/1 _ 2700 K CRI >90 4140,22 lm 66 lm/W
● 93/ __ White (RAL 9016)	/4 _ 4000 K CRI >90 9141 lm 145,1 lm/W

Finish customization
 (Available options:
 Vibia colour palette)

Control
4460 __ / _ A DALI-2, 1-10V, Push
4460 __ / _ Z Casambi

Materials
 Diffuser: Polycarbonate. Body: Aluminum.
 Ceiling support: Steel.

Light Source and electronics
 1 x LED PLATE 26,5 W 700 mA
 1 x LED PLATE 55,3W 750 mA
 Constant Current 700 / 750 mA
 110-240V 50/60Hz

Packaging
 2 Boxes
 Total Vol 0,1891 m³
 Gross weight 24 Kg Net weight 23 Kg

Notes
 Only one electric connection point

Origami

Design by Ramón Esteve

Recalling the folded paper of the Japanese art form for which it's named, Origami generates a stunning play of light and shadows. Composed of two architectural modules that be arranged in countless personalized designs, it creates the effect of climbing ivy along a blank expanse of wall.

Wall Outdoor

4500

30 cm

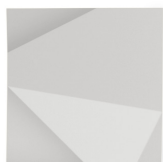

4501

30 cm



4504

53 cm



4506

73 cm

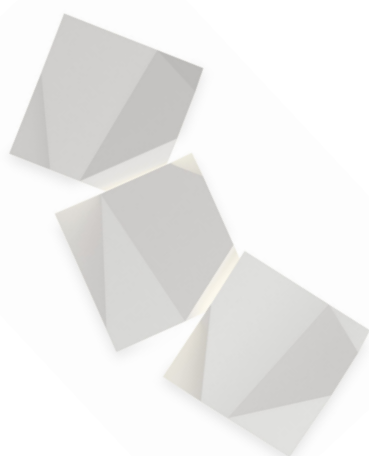

4508

94 cm



Each project is unique. Visit vibia.com and chose among multiple compositions designed and adapted to your project needs.

Personalise your own Origami composition quick and easy at vibia.com

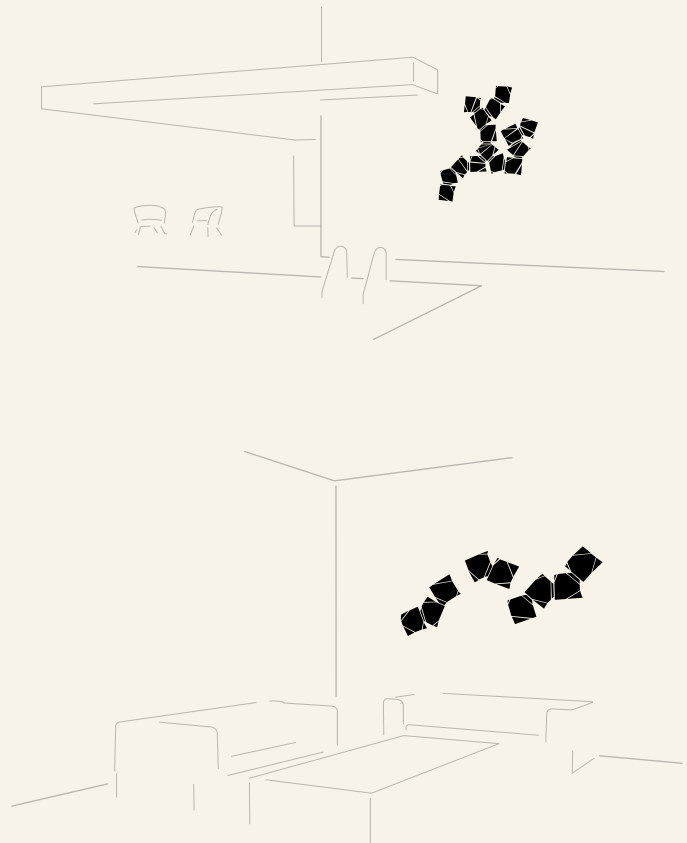

4500

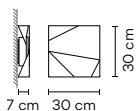

Finishes

- 10/ __ White (NCS S 0300-N)
- 29/ __ Brown D1 (NCS S 8005-Y50R)
- 38/ __ Terra Dark (NCS S 5040-Y70R)
- 53/ __ Green M1 (NCS S 6005-G80Y)

LED temperature colour

- /1 _ 2700 K **D** CRI >90 756,42 lm 120 lm/W
- /3 _ 3500 K **E** CRI >90 799,1 lm 126,8 lm/W

Control

4500 __ / _ 4
 TRIAC

Materials

Shade: ABS. Diffuser: Polycarbonate.
 Lid: Polycarbonate. Arm: Polycarbonate.

Light Source and electronics

1 x LED STRIP 6,3 W 350 mA
 Constant Current 350 mA
 110-277V 50/60Hz

Packaging

1 Box 0,35 x 0,35 x 0,12 m
 Vol 0,0150 m³
 Gross weight 1,5 Kg Net weight 1 Kg

Notes

A maximum of 30 modules can be connected to a single connection point. For bigger compositions, check connection system



4501

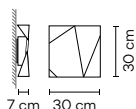

- | | |
|---|-------------------------------|
| Finishes | LED temperature colour |
| ● 10/ __ White
(NCS S 0300-N) | /1 _ 2700 K |
| ● 29/ __ Brown D1
(NCS S 8005-Y50R) | CRI >90 756,42 lm 120 lm/W |
| ● 38/ __ Terra Dark
(NCS S 5040-Y70R) | /3 _ 3500 K |
| ● 53/ __ Green M1
(NCS S 6005-G80Y) | CRI >90 799,1 lm 126,8 lm/W |

Control
4501 __ / _ 4
 TRIAC

Materials
 Shade: ABS. Diffuser: Polycarbonate.
 Lid: Polycarbonate. Arm: Polycarbonate.

Packaging
 1 Box 0,35 x 0,35 x 0,12 m
 Vol 0,0150 m³
 Gross weight 1,5 Kg Net weight 1 Kg

Light Source and electronics
 1 x LED STRIP 6,3 W 350 mA
 Constant Current 350 mA
 110-277V 50/60Hz

Notes
 A maximum of 30 modules can be connected to a single connection point. For bigger compositions, check connection system

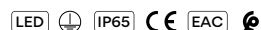

4504

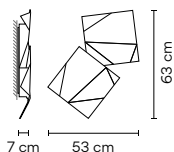

- | | |
|---|-------------------------------|
| Finishes | LED temperature colour |
| ● 10/ __ White
(NCS S 0300-N) | /1 _ 2700 K |
| ● 29/ __ Brown D1
(NCS S 8005-Y50R) | CRI >90 1512,84 lm 120 lm/W |
| ● 38/ __ Terra Dark
(NCS S 5040-Y70R) | /3 _ 3500 K |
| ● 53/ __ Green M1
(NCS S 6005-G80Y) | CRI >90 1598,2 lm 126,8 lm/W |

Control
4504 __ / _ 4
 TRIAC

Materials
 Shade: ABS. Diffuser: Polycarbonate.
 Lid: Polycarbonate. Arm: Polycarbonate.

Packaging
 1 Box 0,64 x 0,40 x 0,22 m
 Vol 0,0563 m³
 Gross weight 4,05 Kg Net weight 2,15 Kg

Light Source and electronics
 2 x LED STRIP 6,3 W 350 mA
 Constant Current 350 mA
 110-277V 50/60Hz

Notes
 A maximum of 30 modules can be connected to a single connection point. For bigger compositions, check connection system

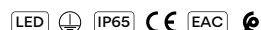

4506

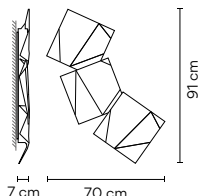

- | | |
|---|-------------------------------|
| Finishes | LED temperature colour |
| ● 10/ __ White
(NCS S 0300-N) | /1 _ 2700 K |
| ● 29/ __ Brown D1
(NCS S 8005-Y50R) | CRI >90 2269,26 lm 120 lm/W |
| ● 38/ __ Terra Dark
(NCS S 5040-Y70R) | /3 _ 3500 K |
| ● 53/ __ Green M1
(NCS S 6005-G80Y) | CRI >90 2397,2 lm 126,8 lm/W |

Control
4506 __ / _ 4
 TRIAC

Materials
 Shade: ABS. Diffuser: Polycarbonate.
 Lid: Polycarbonate. Arm: Polycarbonate.

Packaging
 1 Box 0,95 x 0,40 x 0,22 m
 Vol 0,0836 m³
 Gross weight 5,33 Kg Net weight 3,23 Kg

Light Source and electronics
 3 x LED STRIP 6,3 W 350 mA
 Constant Current 350 mA
 110-277V 50/60Hz

Notes
 A maximum of 30 modules can be connected to a single connection point. For bigger compositions, check connection system

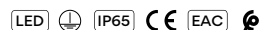

4508

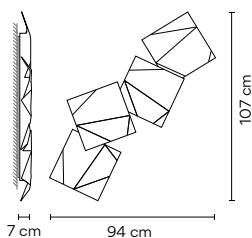

Finishes	LED temperature colour	Control
<ul style="list-style-type: none"> ● 10/ __ White (NCS S 0300-N) ● 29/ __ Brown D1 (NCS S 8005-Y50R) ● 38/ __ Terra Dark (NCS S 5040-Y70R) ● 53/ __ Green M1 (NCS S 6005-G80Y) 	<ul style="list-style-type: none"> /1 2700 K CRI >90 3025,68 lm 120 lm/W /3 3500 K CRI >90 3196,3 lm 126,8 lm/W 	4508 __ / __ 4 TRIAC

Materials

Shade: ABS. Diffuser: Polycarbonate.
 Lid: Polycarbonate. Arm: Polycarbonate.

Light Source and electronics

4 x LED STRIP 6,3 W 350 mA
 Constant Current 350 mA
 110-277V 50/60Hz

Packaging

1 Box 1,25 x 0,40 x 0,22 m
 Vol 0,1100 m³
 Gross weight 7,2 Kg Net weight 6,48 Kg

Notes

A maximum of 30 modules can be connected to a single connection point. For bigger compositions, check connection system

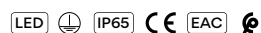

Palo Alto

Design by Xuclà

At once natural and architectural, Palo Alto creates the effect of illuminated landscaping. Its angular, tree-shaped silhouette integrates seamlessly with the outdoors whether displayed individually or in a group.

Outdoor

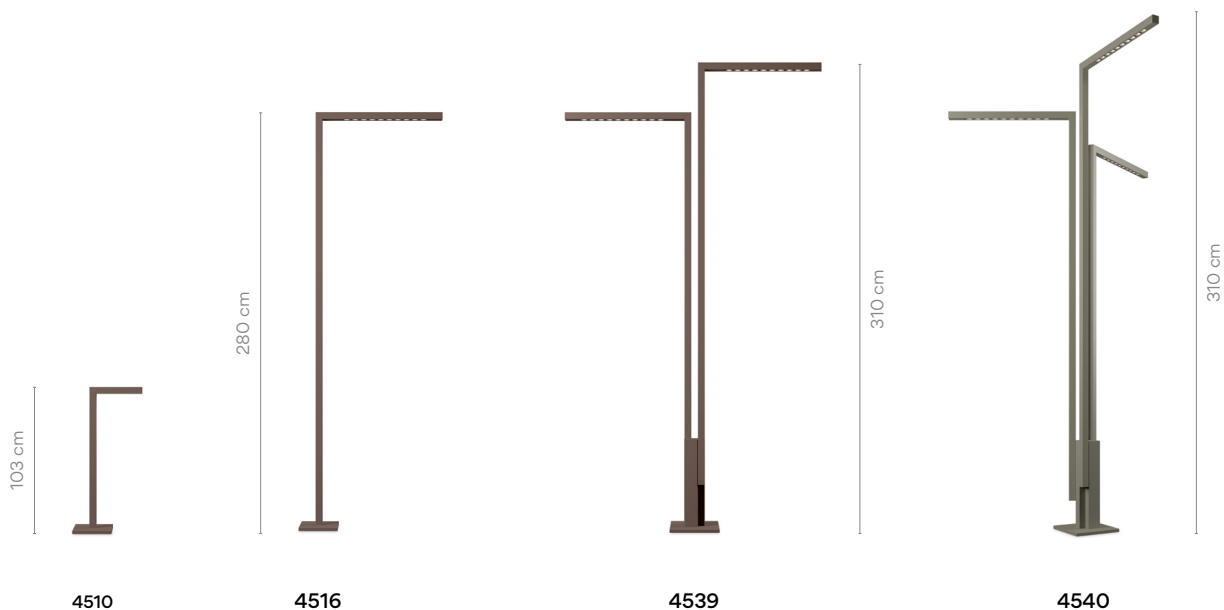

4510



Finishes	LED temperature colour
● 29/ __ Brown D1 (S 8005-Y50R)	/1_ 2700 K
● 53/ __ Green M1 (S 6005-G80Y)	CRI >90 179,64 lm 41 lm/W
	/3_ 3500 K
	CRI >90 179,6 lm 40,8 lm/W

Control
4510 __ / _ 0
On/ Off

Materials
Body: Steel.
Cover: Steel.

Light Source and electronics
2 x LED 2,2 W 700 mA
Constant Current 700 mA
220-240V 50/60Hz

Packaging
1 Box 0,44 x 0,40 x 1,10 m
Vol 0,2080 m³
Gross weight 11,1 Kg Net weight 10 Kg

4516

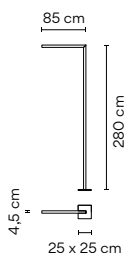

Finishes	LED temperature colour
● 29/ __ Brown D1 (S 8005-Y50R)	/1_ 2700 K
● 53/ __ Green M1 (S 6005-G80Y)	CRI >90 1044,95 lm 70 lm/W
	/3_ 3500 K
	CRI >90 1045,0 lm 69,7 lm/W

Control
4516 __ / _ 0
On/ Off

Materials
Body: Steel.
Cover: Steel.

Light Source and electronics
1 x LED MODULE 24V 15 W
Constant Voltage 24V
100-240V 50/60Hz

Packaging
1 Box 0,32 x 0,32 x 2,64 m
Vol 0,2703 m³
Gross weight 18,4 Kg Net weight 16,5 Kg

4539

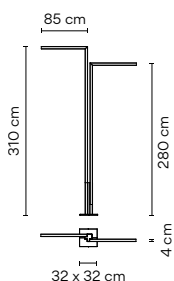

- Finishes**
- 29/ __ Brown D1 (S 8005-Y50R)
 - 53/ __ Green M1 (S 6005-G80Y)

- LED temperature colour**
- /1 _ 2700 K CRI >90 2089,9 lm 70 lm/W
 - /3 _ 3500 K CRI >90 2089,9 lm 69,7 lm/W

Control
 4539 __ / _ 0
 On/ Off

Materials

Body: Steel.
 Cover: Steel.

Light Source and electronics

2 x LED MODULE 24V 15 W
 Constant Voltage 24V
 100~240V 50/60Hz

Packaging

1 Box 0,37 x 0,37 x 2,61 m
 Vol 0,3570 m³
 Gross weight 46,4 Kg Net weight 41,76 Kg



4540

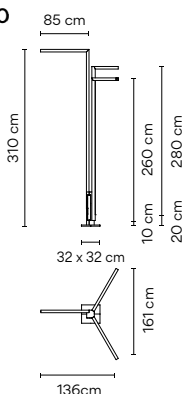

- Finishes**
- 29/ __ Brown D1 (S 8005-Y50R)
 - 53/ __ Green M1 (S 6005-G80Y)

- LED temperature colour**
- /1 _ 2700 K CRI >90 3134,85 lm 70 lm/W
 - /3 _ 3500 K CRI >90 3134,9 lm 69,7 lm/W

Control
 4540 __ / _ 0
 On/ Off

Materials

Body: Steel.
 Cover: Steel.

Light Source and electronics

3 x LED MODULE 24V 15 W
 Constant Voltage 24V
 100~240V 50/60Hz

Packaging

1 Box 0,40 x 0,44 x 2,64 m
 Vol 0,4646 m³
 Gross weight 55,4 Kg Net weight 49,86 Kg



Brisa

Design by Lievore, Altherr, Molina

Inspired by the forest blue bell flower, Brisa adds a nature-inspired accent to any outdoor space. Its long, slender stem is topped with a pendant, conical shade and features adjustable, revolving arms.

Outdoor



4625

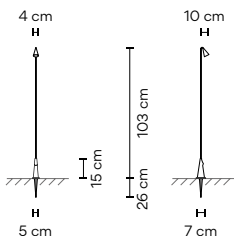

Finishes	LED temperature colour	Control
● 07/ __ Khaki (RAL 7039)	/1_ 2700 K	4625 __ / __ 0
● 54/ __ Oxide (RAL 8014)	/3_ 3500 K	On/ Off
	CRI >90 181,22 lm 86 lm/W	
	CRI >90 193,9 lm 92,3 lm/W	

Materials
Shade and Base: Aluminum. Disc: Stainless steel.
Vertical tube: Steel.

Light Source and electronics
1 x LED 2,1 W 700 mA
Constant Current 700 mA
100-240V 50/60Hz

Packaging
1 Box 0,16 x 0,16 x 1,6 m
Vol 0,0409 m³
Gross weight 1,8 Kg Net weight 1,3 Kg

Notes
Spike. Surface



4630

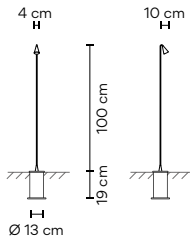

Finishes	LED temperature colour
● 07/ _ _ Khaki (RAL 7039)	/1_ 2700 K CRI >90 543,66 lm 86 lm/W
● 54/ _ _ Oxide (RAL 8014)	/3_ 3500 K CRI >90 581,7 lm 92,3 lm/W

Control
 4630 _ _ / _ 0
 On/ Off

Materials
 Shade and Base: Aluminum. Disc: Stainless steel.
 Vertical tube: Steel.

Packaging
 1 Box 0,16 x 0,16 x 1,6 m
 Vol 0,0409 m³
 Gross weight 2,6 Kg Net weight 2 Kg

Light Source and electronics
 1 x LED 2,1 W 700 mA
 Constant Current 700 mA
 100~240V 50/60Hz

Notes
 Built-in
 ø 13 cm

4635

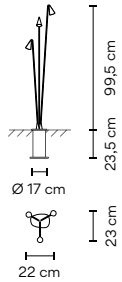

Finishes	LED temperature colour
● 07/ _ _ Khaki (RAL 7039)	/1_ 2700 K CRI >90 906,1 lm 86 lm/W
● 54/ _ _ Oxide (RAL 8014)	/3_ 3500 K CRI >90 969,5 lm 92,3 lm/W

Control
 4635 _ _ / _ 0
 On/ Off

Materials
 Shade and Base: Aluminum. Disc: Stainless steel.
 Vertical tube: Steel.

Packaging
 1 Box 0,32 x 0,36 x 1,16 m
 Vol 0,1336 m³
 Gross weight 6,5 Kg Net weight 5,85 Kg

Light Source and electronics
 3 x LED 2,1 W 700 mA
 Constant Current 700 mA
 100~240V 50/60Hz

Notes
 Built-in
 ø 17 cm

4640

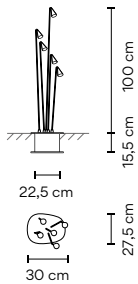

Finishes	LED temperature colour
● 07/ _ _ Khaki (RAL 7039)	/1_ 2700 K CRI >90 1268,54 lm 86 lm/W
● 54/ _ _ Oxide (RAL 8014)	/3_ 3500 K CRI >90 1357,3 lm 92,3 lm/W

Control
 4640 _ _ / _ 0
 On/ Off

Materials
 Shade and Base: Aluminum. Disc: Stainless steel.
 Vertical tube: Steel.

Packaging
 1 Box 0,32 x 0,36 x 1,16 m
 Vol 0,1336 m³
 Gross weight 6 Kg Net weight 4 Kg

Light Source and electronics
 5 x LED 2,1 W 700 mA
 Constant Current 700 mA
 100~240V 50/60Hz

Notes
 Built-in
 ø 22,5 cm

Dots

Design by Martín Azúa

A diminutive wall sconce delivers outsized impact in the form of simple, circular dots. Seamlessly connecting a space with an intimate landscape of beams and halos, the collection creates a melody of light like a composition of musical notes in concert with another.

Wall



4660 - 4662



4665

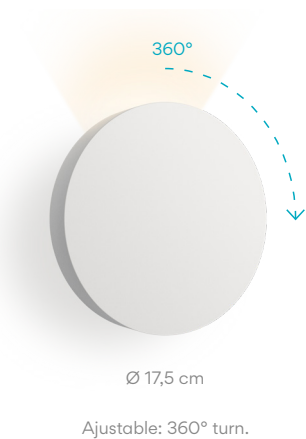

4670



4675

4660

- Finishes
- 13/ __ Off-White (NCS S 1000-N)
 - 27/ __ Brown L1 (NCS S 1505-Y50R)
 - 37/ __ Terra Red (NCS S 4040-Y70R)
 - 47/ __ Green L1 (NCS S 4005-G80Y)

LED temperature colour
 /1 _ 2700 K 
 CRI >90 482,65 lm 84 lm/W

Control
 4660 __ / _ 0
 On/ Off
 4660 __ / _ 1
 DALI-2
 4660 __ / _ 3
 1-10V
 4660 __ / _ 4
 TRIAC

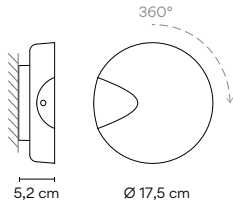

- Finishes
- 82/ __ White oak
 - 83/ __ American walnut

LED temperature colour
 /1 _ 2700 K 
 CRI >90 482,65 lm 84 lm/W

Control
 4660 __ / _ 0
 On/ Off
 4660 __ / _ 1
 DALI-2
 4660 __ / _ 3
 1-10V
 4660 __ / _ 4
 TRIAC

Materials

Body: ABS or Natural wood. Diffuser: Polycarbonate.
 Canopy: Aluminum.

Light Source and electronics

1 x LED 5,75 W 500 mA
 Constant Current 500 mA
 220~240V 50/60Hz

Packaging

1 Box 0,13 x 0,22 x 0,21 m
 Vol 0,0062 m³
ABS: Gross weight 0,65 Kg
 Net weight 0,4 Kg
Natural wood: Gross weight 0,85 Kg
 Net weight 0,6 Kg

Notes

22° light halo



4662

- Finishes
- 13/ __ Off-White (NCS S 1000-N)
 - 27/ __ Brown L1 (NCS S 1505-Y50R)
 - 37/ __ Terra Red (NCS S 4040-Y70R)
 - 47/ __ Green L1 (NCS S 4005-G80Y)

LED temperature colour
 /1 _ 2700 K 
 CRI >90 482,65 lm 84 lm/W

Control
 4662 __ / _ 0
 On/ Off
 4662 __ / _ 4
 TRIAC

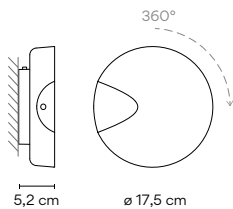

- Finishes
- 82/ __ White oak
 - 83/ __ American walnut

LED temperature colour
 /1 _ 2700 K 
 CRI >90 482,65 lm 84 lm/W

Control
 4662 __ / _ 0
 On/ Off
 4662 __ / _ 4
 TRIAC

Materials

Body: ABS or Natural wood. Diffuser: Polycarbonate.
 Canopy: Aluminum.

Light Source and electronics

1 x LED 5,75 W 500 mA
 Constant Current 500 mA
 220~240V 50/60Hz

Packaging

1 Box 0,13 x 0,22 x 0,21 m
 Vol 0,0062 m³
ABS: Gross weight 0,65 Kg
 Net weight 0,4 Kg
Natural wood: Gross weight 0,85 Kg
 Net weight 0,6 Kg

Notes

22° light halo
 Switch on the back plate



4665

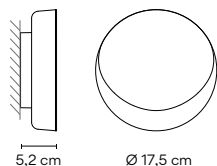

- Finishes**
- 13/ __ Off-White (NCS S 1000-N)
 - 27/ __ Brown L1 (NCS S 1505-Y50R)
 - 37/ __ Terra Red (NCS S 4040-Y70R)
 - 47/ __ Green L1 (NCS S 4005-G80Y)
- LED temperature colour**
- /1_ 2700 K CRI >90 482,65 lm 84 lm/W

Control

4665 __ / _ 0
On/ Off

Materials

Body: ABS. Diffuser: Polycarbonate.
Canopy: Aluminum.

Packaging

1 Box 0,13 x 0,22 x 0,21 m
Vol 0,0062 m³
Gross weight 0,65 Kg Net weight 0,4 Kg

Light Source and electronics

1 x LED 5,75 W 500 mA
Constant Current 500 mA
220~240V 50/60Hz

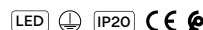

4670

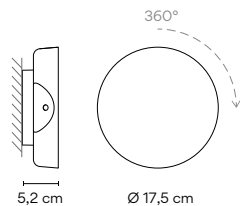

- Finishes**
- 13/ __ Off-White (NCS S 1000-N)
 - 27/ __ Brown L1 (NCS S 1505-Y50R)
 - 37/ __ Terra Red (NCS S 4040-Y70R)
 - 47/ __ Green L1 (NCS S 4005-G80Y)
- LED temperature colour**
- /1_ 2700 K CRI >90 482,65 lm 84 lm/W

Control

4670 __ / _ 0
On/ Off

4670 __ / _ 1
DALI-2

4670 __ / _ 3
1-10V

4670 __ / _ 4
TRIAC

- Finishes**
- 82/ __ White oak
 - 83/ __ American walnut
- LED temperature colour**
- /1_ 2700 K CRI >90 482,65 lm 84 lm/W

Control

4670 __ / _ 0
On/ Off

4670 __ / _ 1
DALI-2

4670 __ / _ 3
1-10V

4670 __ / _ 4
TRIAC

Materials

Body: ABS or Natural wood. Diffuser: Polycarbonate.
Canopy: Aluminum.

Packaging

1 Box 0,13 x 0,22 x 0,21 m
Vol 0,0062 m³
ABS: Gross weight 0,65 Kg
Net weight 0,4 Kg
Natural wood: Gross weight 0,85 Kg
Net weight 0,6 Kg

Light Source and electronics

1 x LED 5,75 W 500 mA
Constant Current 500 mA
220~240V 50/60Hz

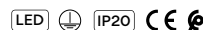

4675

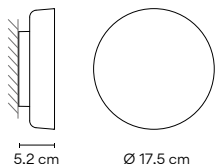

Finishes	LED temperature colour	Control
● 13/ _ _ Off-White (NCS S 1000-N)	/1_ 2700 K CRI >90 573,83 lm 128 lm/W	4675 _ _ / _ 0 On/ Off
● 27/ _ _ Brown L1 (NCS S 1505-Y50R)		4675 _ _ / _ 1 DALI-2
● 37/ _ _ Terra Red (NCS S 4040-Y70R)		4675 _ _ / _ 3 1-10V
● 47/ _ _ Green L1 (NCS S 4005-G80Y)		4675 _ _ / _ 4 TRIAC

Finishes	LED temperature colour	Control
● 82/ _ _ White oak	/1_ 2700 K CRI >90 482,65 lm 84 lm/W	4675 _ _ / _ 0 On/ Off
● 83/ _ _ American walnut		4675 _ _ / _ 1 DALI-2
		4675 _ _ / _ 3 1-10V
		4675 _ _ / _ 4 TRIAC

Materials

Body: ABS or Natural wood. Diffuser: Polycarbonate.
 Canopy: Aluminum.

Light Source and electronics

1 x LED PLATE 4,5 W 500 mA
 Constant Current 500 mA
 100~240V 50/60Hz

Packaging

1 Box 0,13 x 0,22 x 0,21 m
 Vol 0,0062 m³
ABS: Gross weight 0,65 Kg
 Net weight 0,4 Kg
Natural wood: Gross weight 0,85 Kg
 Net weight 0,6 Kg

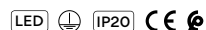

Dots Outdoor

Design by Martín Azúa

Easily mistaken for a stone during the day, this fixture is designed to nestle into the undergrowth of a garden or amongst the potted plants of a patio. Dots Outdoor shines at night with a low, diffuse and indirect glow, the source of which is invisible from almost any angle.

Outdoor

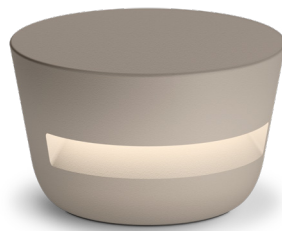

ø 20 cm

4695

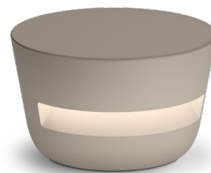

ø 16 cm

4697



ø 20 cm

4700



ø 16 cm

4702

4695

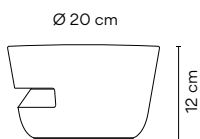

- Finishes**
- **22/** ___ Graphite Black (NCS S 8000-N)
 - **25/** ___ Beige D1 (NCS S 4005-Y50R)
 - **53/** ___ Green M1 (NCS S 6005-G80Y)

LED temperature colour
/1 _ 2700 K 
CRI >90 750,2 lm 96,18 lm/W

Control
4695 _ _ / _ 0
On/ Off
4695 _ _ / _ 1 _ 30
DALI (Remote)
4695 _ _ / _ Z _ 30
Casambi (Remote)

Materials
Body: Aluminium.
Diffuser: Polycarbonate.

Light Source and electronics
1 x LED STRIP 7,8W 350 mA
Constant Current 350 mA
100~277V 50/60Hz

Packaging
1 Box 0,30 x 0,27 x 0,18 m
Vol 0,0146 m³
Gross weight 3,4 Kg Net weight 2,7 Kg

     **Multi-volt**

4697

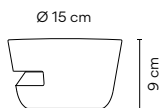

- Finishes
- 22/ _ _ Graphite Black (NCS S 8000-N)
 - 25/ _ _ Beige D1 (NCS S 4005-Y50R)
 - 53/ _ _ Green M1 (NCS S 6005-G80Y)

LED temperature colour
 /1 _ 2700 K
 CRI >90 375,9 lm 81,72 lm/W

Control
 4697 _ _ / _ 0
 On/ Off
 4697 _ _ / _ 1 30
 DALI (Remote)
 4697 _ _ / _ Z 30
 Casambi (Remote)

Materials
 Body: Aluminium.
 Diffuser: Polycarbonate.

Light Source and electronics
 1 x LED STRP 4,6W 350 mA
 Constant Current 350 mA
 100~240V 50/60Hz

Packaging
 1 Box 0,24 x 0,20 x 0,13 m
 Vol 0,0624 m³
 Gross weight 1,9 Kg Net weight 1,5 Kg

4700

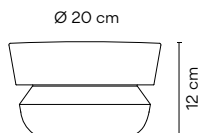

- Finishes
- 22/ _ _ Graphite Black (NCS S 8000-N)
 - 25/ _ _ Beige D1 (NCS S 4005-Y50R)
 - 53/ _ _ Green M1 (NCS S 6005-G80Y)

LED temperature colour
 /1 _ 2700 K
 CRI >90 1445 lm 97,64 lm/W

Control
 4700 _ _ / _ 0
 On/ Off
 4700 _ _ / _ 1 30
 DALI (Remote)
 4700 _ _ / _ Z 30
 Casambi (Remote)

Materials
 Body: Aluminium.
 Diffuser: Polycarbonate.

Light Source and electronics
 1 x LED STRIP 14,8W 350 mA
 Constant Current 350 mA
 100~277V 50/60Hz

Packaging
 1 Box 0,30 x 0,27 x 0,18 m
 Vol 0,0146 m³
 Gross weight 3,8 Kg Net weight 3,1 Kg

4702

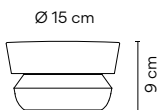

- Finishes
- 22/ _ _ Graphite Black (NCS S 8000-N)
 - 25/ _ _ Beige D1 (NCS S 4005-Y50R)
 - 53/ _ _ Green M1 (NCS S 6005-G80Y)

LED temperature colour
 /1 _ 2700 K
 CRI >90 1294 lm 101,1 lm/W

Control
 4702 _ _ / _ 0
 On/ Off
 4702 _ _ / _ 1 30
 DALI (Remote)
 4702 _ _ / _ Z 30
 Casambi (Remote)

Materials
 Body: Aluminium.
 Diffuser: Polycarbonate.

Light Source and electronics
 1 x LED STRIP 12,8W 300 mA
 Constant Current 300 mA
 100~277V 50/60Hz

Packaging
 1 Box 0,24 x 0,20 x 0,13 m
 Vol 0,0146 m³
 Gross weight 1,9 Kg Net weight 1,5 Kg

Meridiano

Design by Jordi Vilardell & Meritxell Vidal

Meridiano features a grid of steel slots through which LED light radiates outwards in a dramatic sunburst pattern. Topped with foam, it doubles as a seat or side table, its airy architecture integrating easily into outdoor spaces.

Outdoor



4710

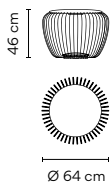

Finishes	LED temperature colour
● 07/ __ Khaki (RAL 7006)	/1 _ 2700 K CRI >90 1269 lm 141 lm/W
● 58/ __ Off-white (PANTONE WARM GRAY 2U)	/3 _ 3500 K CRI >80 1709 lm 189,9 lm/W

Materials
Seat: Polyurethane foam. Rods: Steel.
Arm: Steel. Diffuser: Glass.

Light Source and electronics
1 x LED 9 W 350 mA
Constant Current 350 mA
100~240V 50/60Hz

Control
4710 __ / _ 0
On/ Off

Packaging
1 Box 0,57 x 0,66 x 0,66 m
Vol 0,2483 m³
Gross weight 18,2 Kg Net weight 15,6 Kg

Notes
It can be connected with or without a plug



4715

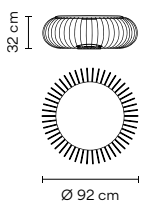

Finishes	LED temperature colour
● 07/ __ Khaki (RAL 7006)	/1 _ 2700 K CRI >90 1269 lm 141 lm/W
● 58/ __ Off-white (PANTONE WARM GRAY 2U)	/3 _ 3500 K CRI >80 1709 lm 189,9 lm/W

Materials
Seat: Polyurethane foam. Rods: Steel.
Arm: Steel. Diffuser: Glass.

Light Source and electronics
1 x LED 9 W 350 mA
Constant Current 350 mA
100~240V 50/60Hz

Control
4715 __ / _ 0
On/ Off

Packaging
1 Box 0,43 x 0,94 x 0,94 m
Vol 0,38 m³
Gross weight 20,1 Kg Net weight 16,7 Kg

Notes
It can be connected with or without a plug





4720

Finishes

- 07/ _ _ Khaki (RAL 7006)
- 58/ _ _ Off-white (PANTONE WARM GRAY 2U)

LED temperature colour

- /1 _ 2700 K [D] CRI >90 1269 lm 141 lm/W
- /3 _ 3500 K [C] CRI >80 1709 lm 189,9 lm/W

Control

4720 _ _ / _ 0
 On/ Off

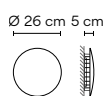

Materials

Base: Steel.

Light Source and electronics

1 x LED 9 W 350 mA
 Constant Current 350 mA
 100~240V 50/60Hz

Packaging

1 Box 0,106 x 0,310 x 0,310 m
 Vol 0,102 m³
 Gross weight 1,5 Kg Net weight 1 Kg



June

Design by Ana Mir + Emili Padrós (emiliana design studio)

Inspired by traditional lanterns, June recall garlands festooned throughout an outdoor space. Its moon-like spheres cast a warm, ambient glow.

Outdoor



4780

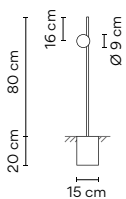

Finishes

● 54/ __ Brown
(Pantone Black U)

LED temperature colour

/1_ 2700 K 
CRI >90 95,5 lm 95 lm/W

Control

4780 __ / _ 0
On/ Off

Materials

Diffuser: Opal blown glass.
Tubes: Steel.

Light Source and electronics

1 x LED 1 W 350 mA
Constant Current 350 mA
100~240V 50/60Hz

Packaging

1 Box 1 x 0,4 x 0,4 m
Vol 0,16 m³
Gross weight 5 Kg Net weight 3 Kg

Notes

Electric cable 4 m

     Bi-volt



4785

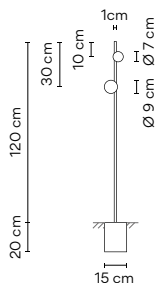

Finishes
 ● 54/ _ _ Brown
 (Pantone Black U)

LED temperature colour
 /1_ 2700 K **F**
 CRI >90 190,9 lm 95 lm/W

Control
 4785 _ _ / _ 0
 On/ Off

Materials

Diffuser: Opal blown glass.
 Tubes: Steel.

Light Source and electronics

2 x LED 1 W 350 mA
 Constant Current 350 mA
 100-240V 50/60Hz

Packaging

1 Box 1,5 x 0,4 x 0,4 m
 Vol 0,24 m³
 Gross weight 6 Kg Net weight 4 Kg

Notes

Electric cable 4 m.

LED IP65 CE EAC Bi-volt

Bamboo

Design by Antoni Arola & Enric Rodríguez

Bamboo's lean, natural form perfectly lends itself to an outdoor setting. Studded with LEDs, it seamlessly integrates with the landscape while adding a wash of light to walkways and common spaces.

Outdoor

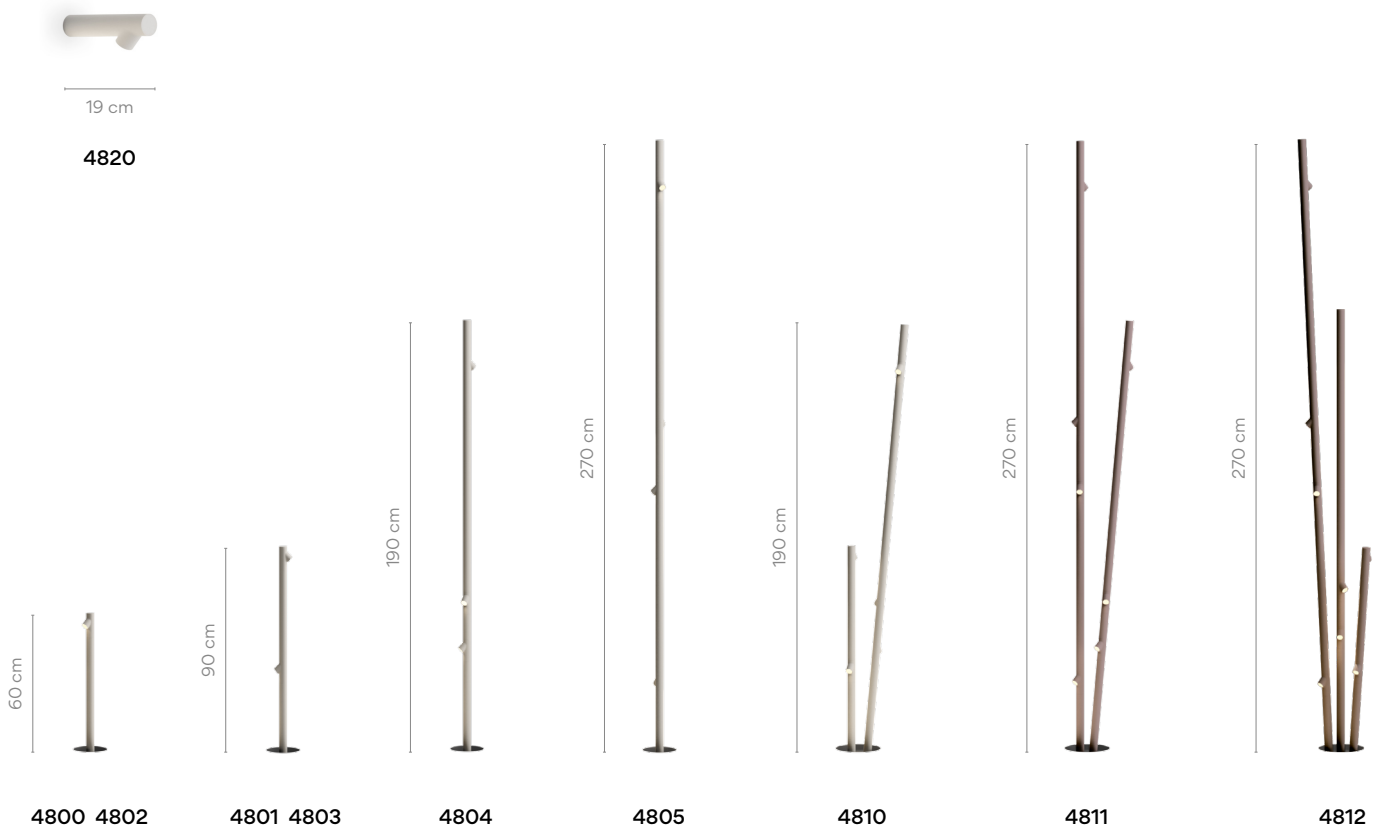

4800

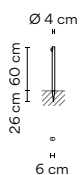

- Finishes**
- 07/ __ Khaki (RAL 7006)
 - 54/ __ Oxide (RAL 8017)
 - 58/ __ Off-white (PANTONE WARM GRAY 2U)

- LED temperature colour**
- /1 _ 2700 K
 - CRI >90 181,2 lm 86 lm/W
 - /3 _ 3500 K
 - CRI >90 181,2 lm 86,3 lm/W

- Control**
- 4800 __ / _ 0
On/ Off

Materials
Cane: Resin + fiberglass.
Diffuser: Methacrylate.

Light Source and electronics
1 x LED 2,1 W 700 mA
Constant Current 700 mA
100~240V 50/60Hz

Packaging
1 Box 0,125 x 0,125 x 1,3 m
Vol 0,0203 m³
Gross weight 4 Kg Net weight 3,6 Kg

Notes
Surface



4801

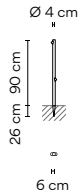

- Finishes**
- 07/ __ Khaki (RAL 7006)
 - 54/ __ Oxide (RAL 8017)
 - 58/ __ Off-white (PANTONE WARM GRAY 2U)

- LED temperature colour**
- /1 _ 2700 K CRI >90 362,4 lm 86 lm/W
 - /3 _ 3500 K CRI >90 362,4 lm 86,3 lm/W

Control
 4801 __ / _ 0
 On/ Off

Materials
 Cane: Resin + fiberglass.
 Diffuser: Methacrylate.

Light Source and electronics
 2 x LED 2,1 W 700 mA
 Constant Current 700 mA
 100~240V 50/60Hz

Packaging
 2 Boxes
 Total Vol 0,0470 m³
 Gross weight 8,5 Kg Net weight 6 Kg

Notes
 Surface

4802

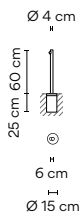

- Finishes**
- 07/ __ Khaki (RAL 7006)
 - 54/ __ Oxide (RAL 8017)
 - 58/ __ Off-white (PANTONE WARM GRAY 2U)

- LED temperature colour**
- /1 _ 2700 K CRI >90 181,2 lm 86 lm/W
 - /3 _ 3500 K CRI >90 181,2 lm 86,3 lm/W

Control
 4802 __ / _ 0
 On/ Off

Materials
 Cane: Resin + fiberglass.
 Diffuser: Methacrylate.

Light Source and electronics
 1 x LED 2,1 W 700 mA
 Constant Current 700 mA
 100~240V 50/60Hz

Packaging
 2 Boxes
 Total Vol 0,0480 m³
 Gross weight 7 Kg Net weight 5,5 Kg

Notes
 Built-in

4803

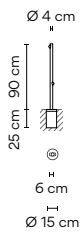

- Finishes**
- 07/ __ Khaki (RAL 7006)
 - 54/ __ Oxide (RAL 8017)
 - 58/ __ Off-white (PANTONE WARM GRAY 2U)

- LED temperature colour**
- /1 _ 2700 K CRI >90 362,4 lm 86 lm/W
 - /3 _ 3500 K CRI >90 362,4 lm 86,3 lm/W

Control
 4803 __ / _ 0
 On/ Off

Materials
 Cane: Resin + fiberglass.
 Diffuser: Methacrylate.

Light Source and electronics
 2 x LED 2,1 W 700 mA
 Constant Current 700 mA
 100~240V 50/60Hz

Packaging
 2 Boxes
 Total Vol 0,0470 m³
 Gross weight 8,5 Kg Net weight 5,8 Kg

Notes
 Built-in

4804

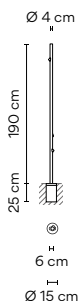

- Finishes**
- 07/ __ Khaki (RAL 7006)
 - 54/ __ Oxide (RAL 8017)
 - 58/ __ Off-white (PANTONE WARM GRAY 2U)
- LED temperature colour**
- /1_ 2700 K
 - CRI >90 543,7 lm 86 lm/W
 - /3_ 3500 K
 - CRI >90 543,7 lm 86,3 lm/W

Control
4804 __ / __ 0
On/ Off

Materials
Cane: Resin + fiberglass.
Diffuser: Methacrylate.

Packaging
2 Boxes
Total Vol 0,0480 m³
Gross weight 8 Kg Net weight 6,5 Kg

Light Source and electronics
3 x LED 2,1 W 700 mA
Constant Current 700 mA
100~240V 50/60Hz

Notes
Built-in

4805

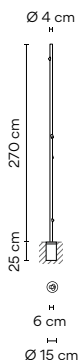

- Finishes**
- 07/ __ Khaki (RAL 7006)
 - 54/ __ Oxide (RAL 8017)
 - 58/ __ Off-white (PANTONE WARM GRAY 2U)
- LED temperature colour**
- /1_ 2700 K
 - CRI >90 724,9 lm 86 lm/W
 - /3_ 3500 K
 - CRI >90 724,9 lm 86,3 lm/W

Control
4805 __ / __ 0
On/ Off

Materials
Cane: Resin + fiberglass.
Diffuser: Methacrylate.

Packaging
2 Boxes
Total Vol 0,0600 m³
Gross weight 9 Kg Net weight 7 Kg

Light Source and electronics
4 x LED 2,1 W 700 mA
Constant Current 700 mA
100~240V 50/60Hz

Notes
Built-in

4810

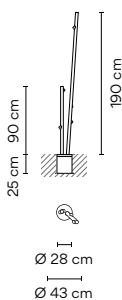

- Finishes**
- 07/ __ Khaki (RAL 7006)
 - 54/ __ Oxide (RAL 8017)
 - 58/ __ Off-white (PANTONE WARM GRAY 2U)
- LED temperature colour**
- /1_ 2700 K
 - CRI >90 906,1 lm 86 lm/W
 - /3_ 3500 K
 - CRI >90 906,1 lm 86,3 lm/W

Control
4810 __ / __ 0
On/ Off

Materials
Cane: Resin + fiberglass.
Diffuser: Methacrylate.

Packaging
3 Boxes
Total Vol 0,1388 m³
Gross weight 15 Kg Net weight 12,5 Kg

Light Source and electronics
5 x LED 2,1 W 700 mA
Constant Current 700 mA
100~240V 50/60Hz

Notes
Built-in

4811

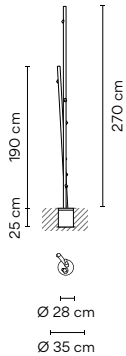

- Finishes**
- 07/ __ Khaki (RAL 7006)
 - 54/ __ Oxide (RAL 8017)
 - 58/ __ Off-white (PANTONE WARM GRAY 2U)

- LED temperature colour**
- /1_ 2700 K [G] CRI >90 1268,5 lm 86 lm/W
 - /3_ 3500 K [G] CRI >90 1268,5 lm 86,3 lm/W

Control
 4811 __ / __ 0
 On/ Off

Materials
 Cane: Resin + fiberglass.
 Diffuser: Methacrylate.

Light Source and electronics
 7 x LED 2,1 W 700 mA
 Constant Current 700 mA
 100~240V 50/60Hz

Packaging
 3 Boxes
 Total Vol 1,660 m³
 Gross weight 16,5 Kg Net weight 13 Kg

Notes
 Built-in
 LED [G] IP66 CE EAC [G] Bi-volt

4812

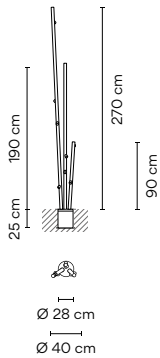

- Finishes**
- 07/ __ Khaki (RAL 7006)
 - 54/ __ Oxide (RAL 8017)
 - 58/ __ Off-white (PANTONE WARM GRAY 2U)

- LED temperature colour**
- /1_ 2700 K [G] CRI >90 1631,0 lm 86 lm/W
 - /3_ 3500 K [G] CRI >90 1631,0 lm 86,3 lm/W

Control
 4812 __ / __ 0
 On/ Off

Materials
 Cane: Resin + fiberglass.
 Diffuser: Methacrylate.

Light Source and electronics
 9 x LED 2,1 W 700 mA
 Constant Current 700 mA
 100~240V 50/60Hz

Packaging
 4 Boxes
 Total Vol 0,1854 m³
 Gross weight 21,6 Kg Net weight 19,44 Kg

Notes
 Built-in
 LED [G] IP66 CE EAC [G] Bi-volt

4820

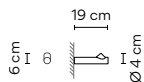

- Finishes**
- 07/ __ Khaki (RAL 7006)
 - 54/ __ Oxide (RAL 8017)
 - 58/ __ Off-white (PANTONE WARM GRAY 2U)

- LED temperature colour**
- /1_ 2700 K [G] CRI >90 181,2 lm 86 lm/W
 - /3_ 3500 K [G] CRI >90 181,2 lm 86,3 lm/W

Control
 4820 __ / __ 0
 On/ Off

Materials
 Cane: Resin + fiberglass.
 Diffuser: Methacrylate.

Light Source and electronics
 1 x LED 2,1 W 700 mA
 Constant Current 700 mA
 100~240V 50/60Hz

Packaging
 1 Box 0,25 x 0,10 x 0,10 m
 Vol 0,0025 m³
 Gross weight 2 Kg Net weight 1 Kg

Notes
 Surface
 LED [G] IP66 CE EAC [G] Bi-volt

Duo

Design by Ramos & Bassols

Natural warmth. Simple volumes with a sculptural quality, easily integrated with the architecture of the ceilings where they are fitted allowing the lights to become focal points without being suspended.

Ceiling

4870

ø 47,5 cm



4872

ø 78,5 cm



4874

ø 35 cm



4878

ø 70 cm



4876

ø 35 cm



4880

ø 70 cm



4870

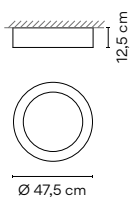

Finishes

- **18/** _ _ Graphite
(Adapta RF9913WX)
- **58/** _ _ Cream
(RAL 7044)
- **93/** _ _ White
(RAL 9016)

Finish customization
(Available options:
Vibia colour palette)

Materials

Diffuser: Polycarbonate. Main Body: Aluminum.
Inner structure: Oak wood.

Light Source and electronics

1 x LED PLATE 26,5 W 700 mA
Constant Current 700 mA
110-240V 50/60Hz

LED temperature colour

- /1_ 2700 K
- CRI >90 2207,0 lm 98 lm/W
- /3_ 3500 K
- CRI >80 2304 lm 102,30 lm/W
- /4_ 4000 K
- CRI >90 2364,6 lm 105,1 lm/W

Control

- 4870** _ _ / _ A
DALI-2, 1-10V, Push
- 4870** _ _ / _ Z
Casambi

Packaging

1 Box 0,56 x 0,56 x 0,26 m
Vol 0,0815 m³
Gross weight 7 Kg Net weight 6 Kg



4872

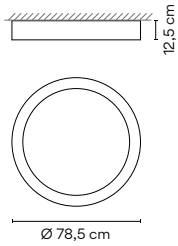

Finishes	LED temperature colour
● 18/ __ Graphite (Adapta RF9913WX)	/1 _ 2700 K CRI >90 3959,0 lm 100 lm/W
● 58/ __ Cream (RAL 7044)	/3 _ 3500 K CRI >90 4133 lm 104,39 lm/W
● 93/ __ White (RAL 9016)	/4 _ 4000 K CRI >90 4241,8 lm 107,3 lm/W

Finish customization
 (Available options:
 Vibia colour palette)

Materials
 Diffuser: Polycarbonate. Main Body: Aluminum.
 Inner structure: Oak wood.

Light Source and electronics
 1 x LED PLATE 50 W 700 mA
 Constant Current 750 mA
 110-240V 50/60Hz

Control
4872 _ / _ A
 DALI-2, 1-10V, Push
4872 _ / _ Z
 Casambi

Packaging
 1 Box 0,9 x 0,9 x 0,25 m
 Vol 0,2025 m³
 Gross weight 19 Kg Net weight 17 Kg



4874

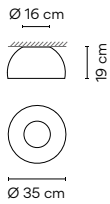

Finishes	LED temperature colour
● 18/ __ Graphite (Adapta RF9913WX)	/1 _ 2700 K CRI >90 644,7 lm 54 lm/W
● 58/ __ Cream (RAL 7044)	/3 _ 3500 K CRI >90 632 lm 52,6 lm/W
● 93/ __ White (RAL 9016)	/4 _ 4000 K CRI >90 690,7 lm 57,6 lm/W

Finish customization
 (Available options:
 Vibia colour palette)

Materials
 Diffuser: Polycarbonate. Main Body: Aluminum.
 Inner structure: Oak wood.

Light Source and electronics
 1 x LED PLATE 12 W 350 mA
 Constant Current 350 mA
 110-240V 50/60Hz

Control
4874 _ / _ 1
 DALI-2
4874 _ / _ B
 1-10V, Push
4874 _ / _ Z
 Casambi

Packaging
 1 Box 0,44 x 0,44 x 0,35 m
 Vol 0,0678 m³
 Gross weight 5 Kg Net weight 4 Kg



4876

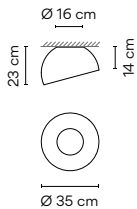

Finishes	LED temperature colour
● 18/ __ Graphite (Adapta RF9913WX)	/1 _ 2700 K CRI >90 644,7 lm 54 lm/W
● 58/ __ Cream (RAL 7044)	/3 _ 3500 K CRI >90 632 lm 52,6 lm/W
● 93/ __ White (RAL 9016)	/4 _ 4000 K CRI >90 690,7 lm 57,6 lm/W

Finish customization
 (Available options:
 Vibia colour palette)

Materials
 Diffuser: Polycarbonate. Main Body: Aluminum.
 Inner structure: Oak wood.

Light Source and electronics
 1 x LED PLATE 12 W 350 mA
 Constant Current 350 mA
 110-240V 50/60Hz

Control
4876 _ / _ 1
 DALI-2
4876 _ / _ B
 1-10V, Push
4876 _ / _ Z
 Casambi

Packaging
 1 Box 0,44 x 0,44 x 0,35 m
 Vol 0,0678 m³
 Gross weight 5 Kg Net weight 4 Kg



4878

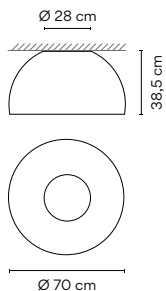

- | | |
|---|--|
| Finishes | LED temperature colour |
| ● 18/ __ Graphite
(Adapta RF9913WX) | /1 _ 2700 K CRI >90 2207 lm 98 lm/W |
| ● 58/ __ Cream
(RAL 7044) | /3 _ 3500 K CRI >90 2304 lm 102,30 lm/W |
| ● 93/ __ White
(RAL 9016) | /4 _ 4000 K CRI >90 2364,6 lm 105,1 lm/W |
- Finish customization**
(Available options:
Vibia colour palette)

Control
4878 __ / __ A
DALI-2, 1-10V, Push
4878 __ / __ Z
Casambi

Materials
Diffuser: Polycarbonate. Main Body: Aluminum.
Inner structure: Oak wood.

Light Source and electronics
1 x LED PLATE 26,5 W 700 mA
Constant Current 350 mA
110-240V 50/60Hz

Packaging
1 Box 0,79 x 0,79 x 0,59 m
Vol 0,3682 m³
Gross weight 16 Kg Net weight 14 Kg

4880

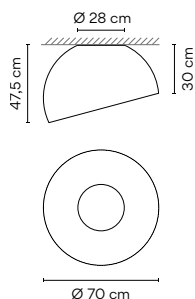

- | | |
|---|--|
| Finishes | LED temperature colour |
| ● 18/ __ Graphite
(Adapta RF9913WX) | /1 _ 2700 K CRI >90 2207 lm 98 lm/W |
| ● 58/ __ Cream
(RAL 7044) | /3 _ 3500 K CRI >90 2304 lm 102,30 lm/W |
| ● 93/ __ White
(RAL 9016) | /4 _ 4000 K CRI >90 2364,6 lm 105,1 lm/W |
- Finish customization**
(Available options:
Vibia colour palette)

Control
4880 __ / __ A
DALI-2, 1-10V, Push
4880 __ / __ Z
Casambi

Materials
Diffuser: Polycarbonate. Main Body: Aluminum.
Inner structure: Oak wood.

Light Source and electronics
1 x LED PLATE 26,5 W 700 mA
Constant Current 350 mA
110-240V 50/60Hz

Packaging
1 Box 0,79 x 0,79 x 0,59 m
Vol 0,3682 m³
Gross weight 16 Kg Net weight 14 Kg









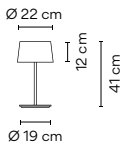

Warm

Design by Ramos & Bassols

Offering a contemporary take on a timeless design, Warm features a generously sized, classic drum shade, with a carefully selected colour palette that provides a contemporary touch.

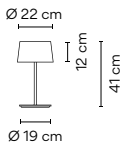
Table



<p>4895</p> 	<p>Finishes</p> <ul style="list-style-type: none"> ● 10 White (NCS S 0300-N) <p>LED 2700 K 470 lm</p> <hr/> <p>Materials</p> <p>Shade: Screen. Diffuser: Methacrylate. Rod: Aluminum. Base: Steel.</p> <p>Light Source and electronics</p> <p>3 x LED G9 230V 3,8 W</p>	<p>4895 10</p> <hr/> <p>Packaging</p> <p>2 Boxes Total Vol 0,0390 m³ Gross weight 2,9 Kg Net weight 1,3 Kg</p> <p>Notes</p> <p>On/off switch on the cable. Electric cable 2 m</p> <p>     </p>
<p>4896</p> 	<p>Finishes</p> <ul style="list-style-type: none"> ● 10 White (NCS S 0300-N) ● 25 Beige D1 (NCS S 4005-Y50R) ● 28 Brown M1 (NCS S 4020-Y60R) ● 56 Green D1 (NCS S 7010-G30Y) <p>LED 2700 K 470 lm</p> <hr/> <p>Finish customization</p> <p>(Available options: Vibia colour palette)</p> <p>Materials</p> <p>Shade: Aluminum. Diffuser: Methacrylate. Rod: Aluminum. Base: Steel.</p> <p>Light Source and electronics</p> <p>3 x LED G9 230V 3,8 W</p>	<p>4896 --</p> <hr/> <p>Packaging</p> <p>2 Boxes Total Vol 0,0390 m³ Gross weight 2,9 Kg Net weight 2 Kg</p> <p>Notes</p> <p>On/off switch on the cable. Electric cable 2 m</p> <p>     </p>



4900

Finishes

10 White
(NCS S 0300-N)

LED 2700 K 1520 lm

4900 10

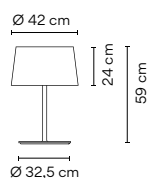

Materials

Shade: Screen. Diffuser: Methacrylate.
Rod: Aluminum. Base: Steel.

Light Source and electronics

3 x LED E27 230V 12 W

Packaging

2 Boxes
Total Vol 0,2153 m³
Gross weight 4,3 Kg Net weight 3,8 Kg

Notes

On/off switch on the cable.
Electric cable 2 m



4901

Finishes

10 White
(NCS S 0300-N)
25 Beige D1
(NCS S 4005-Y50R)
28 Brown M1
(NCS S 4020-Y60R)
56 Green D1
(NCS S 7010-G30Y)

LED 2700 K 1520 lm

4901 __

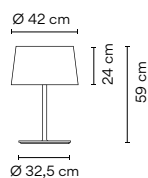

Finish customization
(Available options:
Vibia colour palette)

Materials

Shade: Aluminum. Diffuser: Methacrylate.
Rod: Aluminum. Base: Steel.

Light Source and electronics

3 x LED E27 230V 12 W

Packaging

2 Boxes
Total Vol 0,2153 m³
Gross weight 4,8 Kg Net weight 4,3 Kg

Notes

On/off switch on the cable.
Electric cable 2 m



Warm

Floor



4905 4906

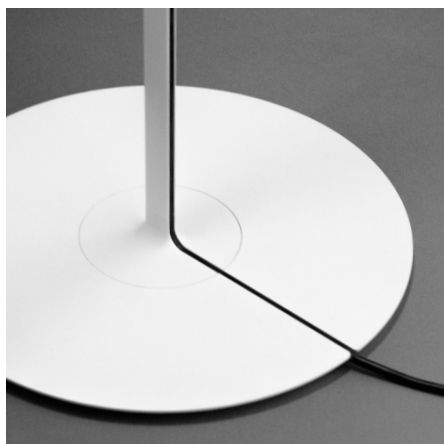

4905

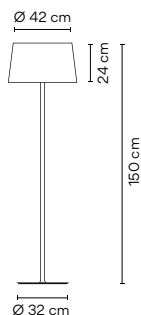

Finishes
 10 White (NCS S 0300-N) LED 2700 K 1520 lm

4905 10

Materials

Shade: Screen. Diffuser: Methacrylate.
 Rod: Aluminum. Base: Steel.

Light Source and electronics
 3 x LED E27 230V 12 W

Packaging

2 Boxes
 Total Vol 0,3426 m³
 Gross weight 10,2 Kg Net weight 6,3 Kg

Notes

On/off switch on the cable.
 Electric cable 2,5 m



4906

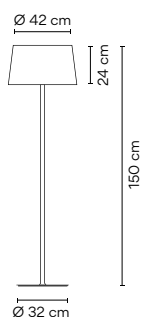

Finishes
 10 White (NCS S 0300-N) LED 2700 K 1520 lm

4906 __

- 25 Beige D1** (NCS S 4005-Y50R)
- 28 Brown M1** (NCS S 4020-Y60R)
- 56 Green D1** (NCS S 7010-G30Y)

Finish customization
 (Available options:
 Vibia colour palette)

Materials

Shade: Aluminum. Diffuser: Methacrylate.
 Rod: Aluminum. Base: Steel.

Light Source and electronics
 3 x LED E27 230V 12 W

Packaging

2 Boxes
 Total Vol 0,3426 m³
 Gross weight 10,7 Kg Net weight 6,8 Kg

Notes

On/off switch on the cable.
 Electric cable 2,5 m



Pendants

4925 4926



ø 62 cm

4930



ø 90 cm



4925

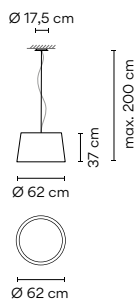

Finishes
 10 White (NCS S 0300-N) LED 2700 K 1520 lm

4925 10

Materials

Shade: Screen. Canopy: Steel.
Diffuser: Methacrylate.

Light Source and electronics
4 x LED E27 230V 12 W

Packaging

1 Box 0,68 x 0,68 x 0,39 m
Vol 0,18 m³
Gross weight 7,7 Kg Net weight 3,9 Kg

Notes

Extra cable length.



4926

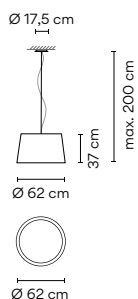

Finishes
 10 White (NCS S 0300-N) LED 2700 K 1520 lm
 25 Beige D1 (NCS S 4005-Y50R)
 28 Brown M1 (NCS S 4020-Y60R)
 56 Green D1 (NCS S 7010-G30Y)

4926 --

Finish customization
(Available options:
Vibia colour palette)

Materials

Shade: Aluminum. Canopy: Steel.
Diffuser: Methacrylate.

Light Source and electronics
4 x LED E27 230V 12 W

Packaging

1 Box 0,77 x 0,77 x 0,50 m
Vol 0,2965 m³
Gross weight 8,9 Kg Net weight 5,1 Kg

Notes

Extra cable length.



4930

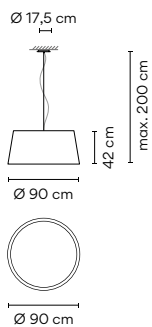

Finishes
 10 White (NCS S 0300-N) LED 2700 K 1520 lm

4930 10

Materials

Shade: Screen. Canopy: Steel.
Diffuser: Methacrylate.

Light Source and electronics
4 x LED E27 230V 12 W

Packaging

1 Box 1,58 x 0,86 x 1,58 m
Vol 2,1469 m³
Gross weight 11,7 Kg Net weight 10,8 Kg

Notes

Extra cable length.

UNTIL STOCK RUNS OUT



Ghost

Design by Arik Levy

A study in contrasts, the Ghost collection embodies both spirit and materiality, discretion and presence. A contemporary reimagining of the grand lights that once graced entryways and living areas, its sensuous form radiates a welcoming, luminous sensitivity.

Table



Ø 47,5 cm

4960



Ø 47,5 cm

4965



Ø 47,5 cm

4970

A colour glass diffuser can be placed in the lower glass for an amber or burgundy light effect



Dimming and installation options



/15: Push-dimming model equipped with two buttons, one for each diffuser. A quick push turns the light on and off, a longer presson dims the light.

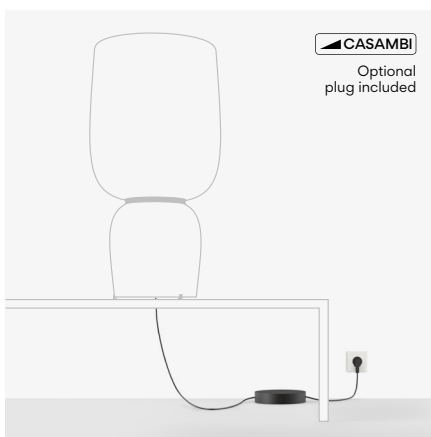
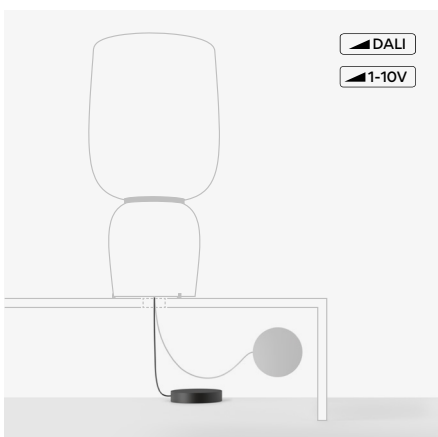

Dimming and installation options: The driver of the DALI, 1-10V and Casambi versions is enclosed in a box at the end of the cable.

4960

Finishes
 ● 11/ __ Black
 (NCS S 8500-N)

LED temperature colour
 /1_ 2700 K
 CRI >90 5432,0 lm 137 lm/W

Control
 4960 __ / _ 1
 DALI

4960 __ / _ 3
 1-10V

4960 __ / _ 5
 Push

4960 __ / _ Z
 Casambi

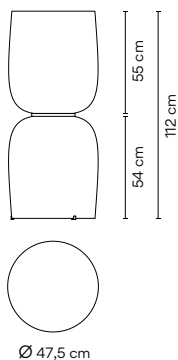

Materials
 Diffuser: Opal Glass.
 Metal parts: Aluminum.

Light Source and electronics
 2 x LED 19,8 W 800 mA
 Constant Current 800 mA
 100~240V 50/60Hz

Packaging
 2 Boxes
 Total Vol 0,6051 m³
 Gross weight 25,7 Kg Net weight 22,7 Kg

Notes
 A colour glass diffuser can be placed in the lower glass for an amber or burgundy light effect. Electric cable 2 m.
 Extra cable length.

LED IP20 Dimmer

4965

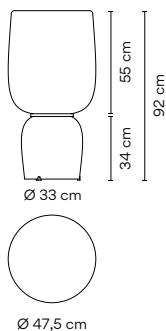

Finishes
 ● 11/ __ Black
 (NCS S 8500-N)

LED temperature colour
 /1_ 2700 K 
 CRI >90 5432,0 lm 137 lm/W

Control
 4965 __ / _ 1
 DALI
 4965 __ / _ 3
 1-10V
 4965 __ / _ 5
 Push
 4965 __ / _ Z
 Casambi

Materials
 Diffuser: Opal Glass.
 Metal parts: Aluminum.

Light Source and electronics
 2 x LED 19,8 W 800 mA
 Constant Current 800 mA
 100~240V 50/60Hz

Packaging
 2 Boxes
 Total Vol 0,6051 m³
 Gross weight 20,6 Kg Net weight 17,6 Kg

Notes
 A colour glass diffuser can be placed in the lower glass for an amber or burgundy light effect. Electric cable 2 m.
 Extra cable length.



4970

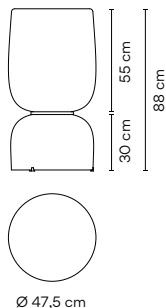

Finishes
 ● 11/ __ Black
 (NCS S 8500-N)

LED temperature colour
 /1_ 2700 K 
 CRI >90 5432,0 lm 137 lm/W

Control
 4970 __ / _ 1
 DALI
 4970 __ / _ 3
 1-10V
 4970 __ / _ 5
 Push
 4970 __ / _ Z
 Casambi

Materials
 Diffuser: Opal Glass.
 Metal parts: Aluminum.

Light Source and electronics
 2 x LED 19,8 W 800 mA
 Constant Current 800 mA
 100~240V 50/60Hz

Packaging
 2 Boxes
 Total Vol 0,6051 m³
 Gross weight 21,7 Kg Net weight 18,7 Kg

Notes
 A colour glass diffuser can be placed in the lower glass for an amber or burgundy light effect. Electric cable 2 m.
 Extra cable length.



Pendants



4987

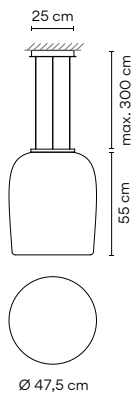

Finishes
 ● **11/ _ _ Black**
 (NCS S 8500-N)

LED temperature colour
 /1_ 2700 K **/1_ 2700 K**
 CRI >90 4826,7 lm 130 lm/W

Control
4987 _ _ / _ A
 DALI-2, 1-10V, Push
4987 _ _ / _ Z
 Casambi

Materials
 Diffuser: Opal Glass.
 Metal parts: Aluminum.

Light Source and electronics
 1 x LED 37,2 W 1050 mA
 Constant Current 1050 mA
 100~240V 50/60Hz

Packaging
 1 Box 0,61 x 0,62 x 0,80 m
 Vol 0,3026 m³
 Gross weight 13,9 Kg Net weight 12,4 Kg
 Extra cable length.

Balance

Design by Jordi Vilardell

Balance features a classic drum shade cantilevered from its column. Adjusting a small pull cord on the diffuser activates the fixture's counterweight system, enabling it to move to the right or left, or up or down-all the while remaining parallel to the floor.

Floor



210 x 260 cm

5189 5190



210 x 215 cm

5191 5192

5189

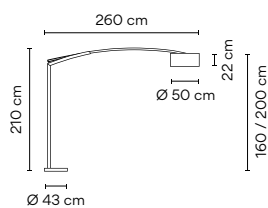

Finishes

- 01 Chrome (Metallic finish)
- 18 Graphite (RAL 7016)
- 30 Nickel (Metallic finish)

Materials

Vertical tube: Aluminum. Base: Steel.
Arm: Inox. Shade: Grey fabric.

Light Source and electronics

LED 2700K 1520 lm Dim
3 x E27 230V 12 W

Control

5189 ---
Push

Packaging

3 Boxes
Total Vol 0,3472 m³
Gross weight 53,8 Kg Net weight 49,5 Kg

Notes

Dimmer on the cable. 3 m

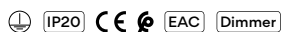

5190

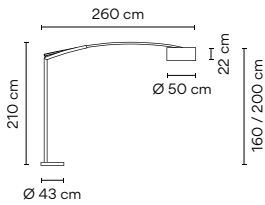

Finishes

- 01 Chrome (Metallic finish)
- 18 Graphite (RAL 7016)
- 30 Nickel (Metallic finish)

Materials

Vertical tube: Aluminum. Base: Steel.
Arm: Inox. Shade: Parchment.

Light Source and electronics

LED 2700K 1520 lm Dim
3 x E27 230V 12 W

Control

5190 _ _
Push

Packaging

3 Boxes
Total Vol 0,3472 m³
Gross weight 53,8 Kg Net weight 49,5 Kg

Notes

Dimmer on the cable. 3 m

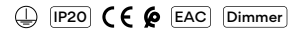

5191

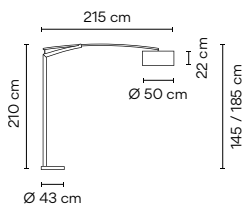

Finishes

- 01 Chrome (Metallic finish)
- 30 Nickel (Metallic finish)

Materials

Vertical tube: Aluminum. Base: Steel.
Arm: Inox. Shade: Parchment.

Light Source and electronics

LED 2700K 1520 lm Dim
3 x E27 230V 12 W

Control

5191 _ _
Push

Packaging

3 Boxes
Total Vol 0,3472 m³
Gross weight 53,8 Kg Net weight 49,1 Kg

Notes

Dimmer on the cable. 3 m



5192

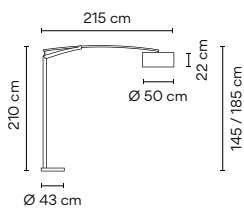

Finishes

- 01 Chrome (Metallic finish)
- 18 Graphite (RAL 7016)
- 30 Nickel (Metallic finish)

Materials

Vertical tube: Aluminum. Base: Steel.
Arm: Inox. Shade: Grey fabric.

Light Source and electronics

LED 2700K 1520 lm Dim
3 x E27 230V 12 W

Control

5192 _ _
Push

Packaging

3 Boxes
Total Vol 0,3472 m³
Gross weight 53,8 Kg Net weight 49,1 Kg

Notes

Dimmer on the cable. 3 m



Puck

Design by Jordi Vilardell

Inspired by the classic circle silhouette, Puck panel light's simple, spherical forms can be superimposed on one another, lending sensibility overhead. Crafted of premium, opal triplex blown glass, it casts a warm glow.

Ceiling Wall



16 cm

5400 5402



24,4 cm

5410



27,2 cm

5412



31,8 cm

5425 5427



46,7 cm

5430 5432

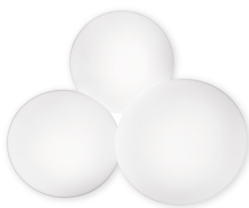

56,8 cm

5435 5437

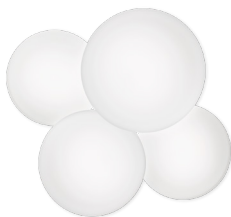

53,2 cm

5440 5442



79 cm

5445 5447

5400

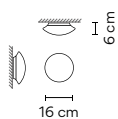

Finishes

● 03 White
(RAL 9016)

LED temperature colour

2700 K 470 lm

5400 03

Materials

Canopy: Aluminum.
Diffuser: Blown-glass.

Light Source and electronics

1 x LED G9 4,2 W

Packaging

1 Box 0,26 x 0,26 x 0,26 m
Vol 0,0175 m³
Gross weight 0,85 Kg Net weight 0,6 Kg

Notes

UNTIL STOCK RUNS OUT



5402

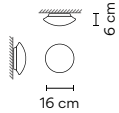

Finishes
 ● 03/ _ _ White (RAL 9016)

LED temperature colour
 /1_ 2700 K CRI >90 415,7 lm 130 lm/W

Control
 5402 _ _ / _ 0
 On/ Off

Materials

Canopy: Aluminum.
 Diffuser: Blown-glass.

Light Source and electronics
 1 x LED PLATE 3,2 W 350 mA
 Constant Current 350 mA
 100~240V 50/60Hz

Packaging

1 Box 0,26 x 0,26 x 0,26 m
 Vol 0,0175 m³
 Gross weight 0,85 Kg Net weight 0,6 Kg

Notes

UNTIL STOCK RUNS OUT



5410

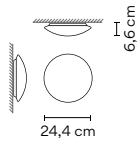

Finishes
 ● 03 White (RAL 9016)

LED temperature colour
 2700 K 470 lm

Control
 5410 03

Materials

Canopy: Aluminum.
 Diffuser: Blown-glass.

Light Source and electronics
 2 x LED G9 4,2 W

Packaging

1 Box 0,37 x 0,37 x 0,23 m
 Vol 0,0315 m³
 Gross weight 0,95 Kg Net weight 0,7 Kg



5412

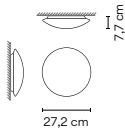

Finishes
 ● 03/ _ _ White (RAL 9016)

LED temperature colour
 /1_ 2700 K CRI >90 880,1 lm 116 lm/W

Control
 5412 _ _ / _ 0
 On/ Off

Materials

Canopy: Aluminum.
 Diffuser: Blown-glass.

Light Source and electronics
 1 x LED PLATE 7,6 W 350 mA
 Constant Current 350 mA
 100~240V 50/60Hz

Packaging

1 Box 0,37 x 0,37 x 0,23 m
 Vol 0,0315 m³
 Gross weight 0,95 Kg Net weight 0,7 Kg



5425

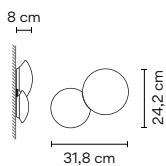

Finishes
 ● 03 White (RAL 9016)

LED temperature colour
 2700 K 470 lm

5425 03

Materials

Canopy: Aluminum.
 Diffuser: Blown-glass.

Light Source and electronics
 2 x LED G9 4,2 W

Packaging

1 Box 0,25 x 0,42 x 0,42 m
 Vol 0,0441 m³
 Gross weight 2,26 Kg Net weight 1,08 Kg

Notes

All version require only one electrical connection



5427

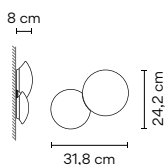

Finishes
 ● 03/ _ _ White (RAL 9016)

LED temperature colour
 /1_ 2700 K CRI >90 831,4 lm 130 lm/W

Control
 5427 _ _ / _ 0
 On/ Off

Materials

Canopy: Aluminum.
 Diffuser: Blown-glass.

Light Source and electronics
 2 x LED PLATE 3,2 W 350 mA
 Constant Current 350 mA
 100~240V 50/60Hz

Packaging

1 Box 0,25 x 0,42 x 0,42 m
 Vol 0,0441 m³
 Gross weight 2,26 Kg Net weight 1,08 Kg

Notes

All version require only one electrical connection



5430 Finishes **03 White** (RAL 9016) LED temperature colour **2700 K 470 lm** **5430 03**

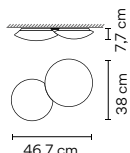

Materials
Canopy: Aluminum.
Diffuser: Blown-glass.

Light Source and electronics
2 x LED G9 4,2 W

Packaging
1 Box 0,27 x 0,60 x 0,60 m
Vol 0,0972 m³
Gross weight 4,2 Kg Net weight 2,15 Kg

Notes
All version require only one electrical connection



5432 Finishes **03/ __ White** (RAL 9016) LED temperature colour **/1_ 2700 K** CRI >90 1760,2 lm 116 lm/W **5432 __ / _ 0** Control **On/ Off**

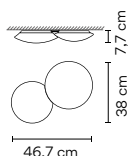

Materials
Canopy: Aluminum.
Diffuser: Blown-glass.

Light Source and electronics
2 x LED PLATE 7,6 W 350 mA
Constant Current 350 mA
100~240V 50/60Hz

Packaging
1 Box 0,27 x 0,60 x 0,60 m
Vol 0,0972 m³
Gross weight 4,2 Kg Net weight 2,15 Kg

Notes
All version require only one electrical connection



5435 Finishes **03 White** (RAL 9016) LED temperature colour **2700 K 470 lm** **5435 03**

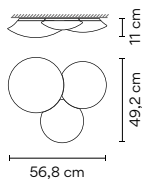

Materials
Canopy: Aluminum.
Diffuser: Blown-glass.

Light Source and electronics
3 x LED G9 4,2 W

Packaging
2 Boxes
Total Vol 0,0780 m³
Gross weight 7,5 Kg Net weight 4,1 Kg

Notes
All version require only one electrical connection



5437 Finishes **03/ __ White** (RAL 9016) LED temperature colour **/1_ 2700 K** CRI >90 2640,4 lm 116 lm/W **5437 __ / _ 0** Control **On/ Off**

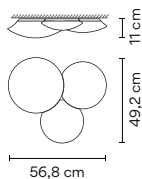

Materials
Canopy: Aluminum.
Diffuser: Blown-glass.

Light Source and electronics
3 x LED PLATE 7,6 W 350 mA
Constant Current 350 mA
100~240V 50/60Hz

Packaging
2 Boxes
Total Vol 0,0780 m³
Gross weight 7,5 Kg Net weight 4,1 Kg

Notes
All version require only one electrical connection



5440

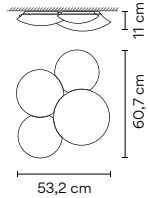

Finishes
 ● 03 White (RAL 9016)

LED temperature colour
 2700 K 470 lm

5440 03

Materials
 Canopy: Aluminum.
 Diffuser: Blown-glass.
 Light Source and electronics
 2 x LED G9 4,2 W

Packaging
 2 Boxes
 Total Vol 0,1060 m³
 Gross weight 7,8 Kg Net weight 4,57 Kg

Notes
 All version require only one electrical connection.

UNTIL STOCK RUNS OUT



5442

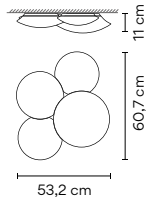

Finishes
 ● 03/ __ White (RAL 9016)

LED temperature colour
 /1_ 2700 K CRI >90 3520,5 lm 116 lm/W

Control
 5442 __ / _ 0
 On/ Off

Materials
 Canopy: Aluminum.
 Diffuser: Blown-glass.
 Light Source and electronics
 4 x LED PLATE 7,6 W 350 mA
 Constant Current 350 mA
 100~240V 50/60Hz

Packaging
 2 Boxes
 Total Vol 0,1060 m³
 Gross weight 7,8 Kg Net weight 4,57 Kg

Notes
 All version require only one electrical connection.

UNTIL STOCK RUNS OUT



5445

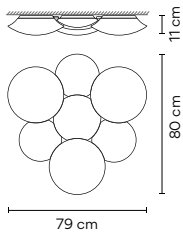

Finishes
 ● 03 White (RAL 9016)

LED temperature colour
 2700 K 470 lm

5445 03

Materials
 Canopy: Aluminum.
 Diffuser: Blown-glass.
 Light Source and electronics
 7 x LED G9 4,2 W

Packaging
 2 Boxes
 Total Vol 0,19 m³
 Gross weight 12,5 Kg Net weight 8,84 Kg

Notes
 All version require only one electrical connection.

UNTIL STOCK RUNS OUT



5447

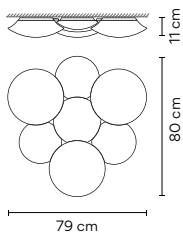

Finishes
 ● 03/ __ White (RAL 9016)

LED temperature colour
 /1_ 2700 K CRI >90 6160,8 lm 116 lm/W

Control
 5447 __ / _ 0
 On/ Off

Materials
 Canopy: Aluminum.
 Diffuser: Blown-glass.
 Light Source and electronics
 7 x LED PLATE 7,6 W 350 mA
 Constant Current 350 mA
 100~240V 50/60Hz

Packaging
 2 Boxes
 Total Vol 0,19 m³
 Gross weight 12,5 Kg Net weight 8,84 Kg

Notes
 All version require only one electrical connection.

UNTIL STOCK RUNS OUT



Puck Wall Art

Design by Jordi Vilardell

Puck Wall Art is comprised of different disks to create a warm, visually sharp and mathematically creative effect. There are four sizes of disks, allowing the designer to play with varied combinations of indirect light. The resulting design comprises a set of highly dynamic, sculptural compositions.

Wall



ø 30 cm

5470



ø 40 cm

5471



ø 45 cm

5472

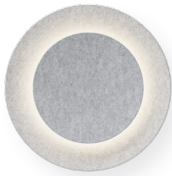

ø 46 cm

5474

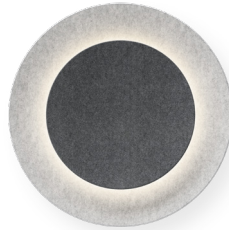

ø 60 cm

5476

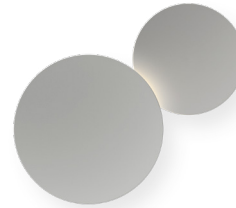

58 cm

5480

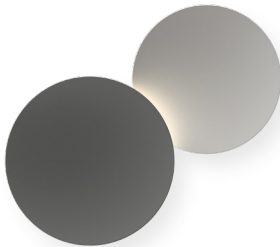

69 cm

5481

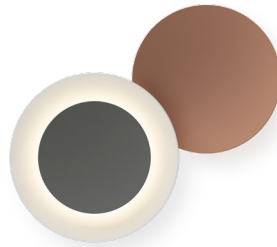

68 cm

5485



87 cm

5487

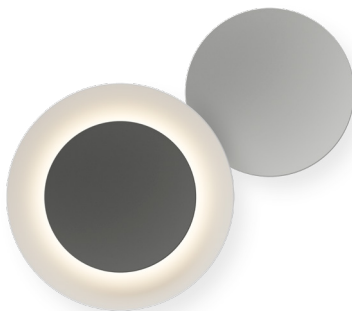

87 cm

5486

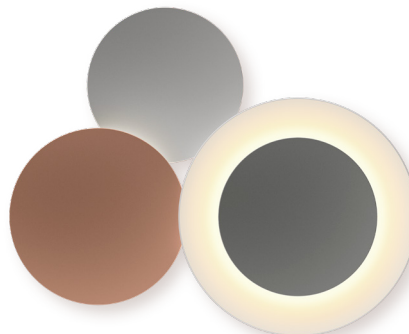

103 cm

5491

Each project is unique.
 Personalise your own
 Puck Wall Art composition
 quick and easy.

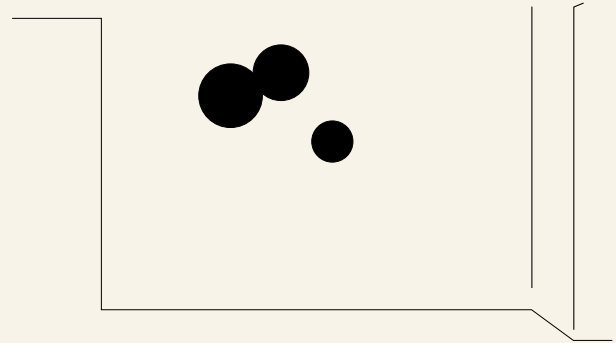

5470

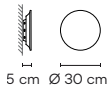

Finishes	LED temperature colour	Control
● 15/ __ Grey L2 (NCS S 2500-N)	/1_ 2700 K CRI >90 952,5 lm 113 lm/W	5470 __ / _ 1 DALI-2
● 21/ __ Black Grey (NCS S 7000-N)	/3_ 3500 K CRI >90 1017,4 lm 121,1 lm/W	5470 __ / _ 3 1-10V
● 28/ __ Brown M1 (NCS S 4020-Y60R)		5470 __ / _ 4 Triac
		5470 __ / _ 5 Push
		5470 __ / _ Z Casambi

Finishes	LED temperature colour	Control
● 76/ __ Grey Felt L1	/1_ 2700 K CRI >90 952,5 lm 113 lm/W	5470 __ / _ 1 DALI-2
● 77/ __ Grey Felt D1	/3_ 3500 K CRI >90 1017,4 lm 121,1 lm/W	5470 __ / _ 3 1-10V
		5470 __ / _ 4 Triac
		5470 __ / _ 5 Push
		5470 __ / _ Z Casambi

Materials
 Diffuser: Polycarbonate. Shade: ABS.
 Wall support: Aluminum.

Light Source and electronics
 1 x LED STRIP 8,4 W 700 mA
 Constant Current 700 mA
 / _ 1 110~240V 50/60Hz Bi-volt
 / _ 3 110~240V 50/60Hz Bi-volt
 / _ 5 110~240V 50/60Hz Bi-volt
 / _ 4 220~240V 50/60Hz
 / _ Z 220~240V 50/60Hz

Packaging
 1 Box 0,34 x 0,34 x 0,23 m
 Vol 0,0266 m³
 Gross weight 2,6 Kg Net weight 1,6 Kg

Notes
 A maximum of 8 modules can be connected to a single connection point. For bigger compositions, check connection system



5471

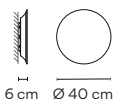

Finishes	LED temperature colour	Control
● 15/ __ Grey L2 (NCS S 2500-N)	/1 _ 2700 K CRI >90 1435,9 lm 114 lm/W	5471 __ / _ 1 DALI-2
● 21/ __ Black Grey (NCS S 7000-N)	/3 _ 3500 K CRI >90 1533,8 lm 121,7 lm/W	5471 __ / _ 3 1-10V
● 28/ __ Brown M1 (NCS S 4020-Y60R)		5471 __ / _ 4 Triac
		5471 __ / _ 5 Push
		5471 __ / _ Z Casambi

Finishes	LED temperature colour	Control
● 76/ __ Grey Felt L1	/1 _ 2700 K CRI >90 1435,9 lm 114 lm/W	5471 __ / _ 1 DALI-2
● 77/ __ Grey Felt D1	/3 _ 3500 K CRI >90 1533,8 lm 121,7 lm/W	5471 __ / _ 3 1-10V
		5471 __ / _ 4 Triac
		5471 __ / _ 5 Push
		5471 __ / _ Z Casambi

Materials

Diffuser: Polycarbonate. Shade: ABS.
Wall support: Aluminum.

Light Source and electronics

1 x LED STRIP 12,6 W 700 mA
Constant Current 700 mA
/ _ 1 110~240V 50/60Hz Bi-volt
/ _ 3 110~240V 50/60Hz Bi-volt
/ _ 5 110~240V 50/60Hz Bi-volt
/ _ 4 220~240V 50/60Hz
/ _ Z 220~240V 50/60Hz

Packaging

1 Box 0,44 x 0,44 x 0,25 m
Vol 0,0484 m³
Gross weight 3,5 Kg Net weight 1,9 Kg

Notes

A maximum of 8 modules can be connected to a single connection point. For bigger compositions, check connection system



5472

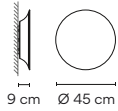

Finishes	LED temperature colour	Control
● 15/ __ Grey L2 (NCS S 2500-N)	/1_ 2700 K CRI >90 1435,9 lm 114 lm/W	5472 __ / _ 1 DALI-2
● 21/ __ Black Grey (NCS S 7000-N)	/3_ 3500 K CRI >90 1533,8 lm 121,7 lm/W	5472 __ / _ 3 1-10V
● 28/ __ Brown M1 (NCS S 4020-Y60R)		5472 __ / _ 4 Triac
		5472 __ / _ 5 Push
		5471 __ / _ Z Casambi

Finishes	LED temperature colour	Control
● 76/ __ Grey Felt L1	/1_ 2700 K CRI >90 1435,9 lm 114 lm/W	5472 __ / _ 1 DALI-2
● 77/ __ Grey Felt D1	/3_ 3500 K CRI >90 1533,8 lm 121,7 lm/W	5472 __ / _ 3 1-10V
		5472 __ / _ 4 Triac
		5472 __ / _ 5 Push
		5472 __ / _ Z Casambi

Materials

Diffuser: Polycarbonate. Shade: ABS.
 Wall support: Aluminum.

Light Source and electronics

1 x LED STRIP 12,6 W 700 mA
 Constant Current 700 mA
 / _ 1 110-240V 50/60Hz Bi-volt
 / _ 3 110-240V 50/60Hz Bi-volt
 / _ 5 110-240V 50/60Hz Bi-volt
 / _ 4 220-240V 50/60Hz
 / _ Z 220-240V 50/60Hz

Packaging

1 Box 0,51 x 0,51 x 0,26 m
 Vol 0,0676 m³
 Gross weight 4,75 Kg Net weight 2,25 Kg

Notes

A maximum of 8 modules can be connected to a single connection point. For bigger compositions, check connection system

LED IP20 CE EAC Bi-volt

5474

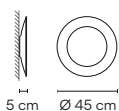

Finishes	LED temperature colour	Control
● 15/ _ _ Grey L2 (NCS S 2500-N)	/1_ 2700 K CRI >90 952,5 lm 113 lm/W	5474 _ _ / _ 1 DALI-2
● 21/ _ _ Black Grey (NCS S 7000-N)	/3_ 3500 K CRI >90 1017,4 lm 121,1 lm/W	5474 _ _ / _ 3 1-10V
● 28/ _ _ Brown M1 (NCS S 4020-Y6OR)		5474 _ _ / _ 4 Triac
		5474 _ _ / _ 5 Push
		5474 _ _ / _ Z Casambi

Finishes	LED temperature colour	Control
● 71/ _ _ Grey Felt L1 & Grey Felt D1	/1_ 2700 K CRI >90 952,5 lm 113 lm/W	5474 _ _ / _ 1 DALI-2
● 76/ _ _ Grey Felt L1	/3_ 3500 K CRI >90 1017,4 lm 121,1 lm/W	5474 _ _ / _ 3 1-10V
		5474 _ _ / _ 4 Triac
		5474 _ _ / _ 5 Push
		5474 _ _ / _ Z Casambi

Materials

Diffuser: Polycarbonate. Shade: ABS.
Wall support: Aluminum. Ring: Steel.

Light Source and electronics

1 x LED STRIP 8,4 W 700 mA
Constant Current 700 mA
/ _ 1 110~240V 50/60Hz Bi-volt
/ _ 3 110~240V 50/60Hz Bi-volt
/ _ 5 110~240V 50/60Hz Bi-volt
/ _ 4 220~240V 50/60Hz
/ _ Z 220~240V 50/60Hz

Packaging

1 Box 0,51 x 0,51 x 0,26 m
Vol 0,0676 m³
Gross weight 4,75 Kg Net weight 2,25 Kg

Notes

A maximum of 8 modules can be connected to a single connection point. For bigger compositions, check connection system



5476

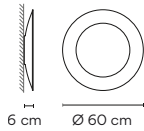

Finishes	LED temperature colour	Control
● 15/ __ Grey L2 (NCS S 2500-N)	/1_ 2700 K CRI >90 1435,9 lm 114 lm/W	5476 __ / _ 1 DALI-2
● 21/ __ Black Grey (NCS S 7000-N)	/3_ 3500 K CRI >90 1533,8 lm 121,7 lm/W	5476 __ / _ 3 1-10V
● 28/ __ Brown M1 (NCS S 4020-Y60R)		5476 __ / _ 4 Triac
		5476 __ / _ 5 Push
		5476 __ / _ Z Casambi

Finishes	LED temperature colour	Control
● 71/ __ Grey Felt L1 & Grey Felt D1	/1_ 2700 K CRI >90 1435,9 lm 114 lm/W	5476 __ / _ 1 DALI-2
● 76/ __ Grey Felt L1	/3_ 3500 K CRI >90 1533,8 lm 121,7 lm/W	5476 __ / _ 3 1-10V
		5476 __ / _ 4 Triac
		5476 __ / _ 5 Push
		5476 __ / _ Z Casambi

Materials

Diffuser: Polycarbonate. Shade: ABS.
 Wall support: Aluminum. Ring: Steel.

Light Source and electronics

1 x LED STRIP 12,6 W 700 mA
 Constant Current 700 mA
 / _ 1 110-240V 50/60Hz Bi-volt
 / _ 3 110-240V 50/60Hz Bi-volt
 / _ 5 110-240V 50/60Hz Bi-volt
 / _ 4 220-240V 50/60Hz
 / _ Z 220-240V 50/60Hz

Packaging

1 Box 0,66 x 0,66 x 0,235 m
 Vol 0,1024 m³
 Gross weight 6,3 Kg Net weight 2,9 Kg

Notes

A maximum of 8 modules can be connected to a single connection point. For bigger compositions, check connection system

LED IP20 CE EAC Bi-volt

5480

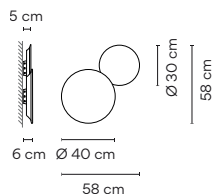

Finishes	LED temperature colour	Control
● 15/ _ _ Grey L2 (NCS S 2500-N)	/1_ 2700 K CRI >90 2388,4 lm 114 lm/W	5480 _ _ / _ 1 DALI-2
● 28/ _ _ Brown M1 (NCS S 4020-Y60R)	/3_ 3500 K CRI >90 2551,3 lm 121,5 lm/W	5480 _ _ / _ 3 1-10V
● 72/ _ _ Grey D1 & Grey L2		5480 _ _ / _ 4 Triac
		5480 _ _ / _ 5 Push
		5480 _ _ / _ Z Casambi

Finishes	LED temperature colour	Control
● 71/ _ _ Grey Felt L1 & Grey Felt D1	/1_ 2700 K CRI >90 2388,4 lm 114 lm/W	5480 _ _ / _ 1 DALI-2
● 76/ _ _ Grey Felt L1	/3_ 3500 K CRI >90 2551,3 lm 121,5 lm/W	5480 _ _ / _ 3 1-10V
		5480 _ _ / _ 4 Triac
		5480 _ _ / _ 5 Push
		5480 _ _ / _ Z Casambi

Materials

Diffuser: Polycarbonate. Shade: ABS.
Wall support: Aluminum.

Light Source and electronics

1 x LED STRIP 8,4 W 700 mA
1 x LED STRIP 12,6 W 700 mA
Constant Current 700 mA
/ _ 1 110~240V 50/60Hz Bi-volt
/ _ 3 110~240V 50/60Hz Bi-volt
/ _ 5 110~240V 50/60Hz Bi-volt
/ _ 4 220~240V 50/60Hz
/ _ Z 220~240V 50/60Hz

Packaging

1 Box 0,46 x 0,46 x 0,4 m
Vol 0,0846 m³
Gross weight 6,1 Kg Net weight 3,4 Kg

Notes

A maximum of 8 modules can be connected to a single connection point. For bigger compositions, check connection system



5481

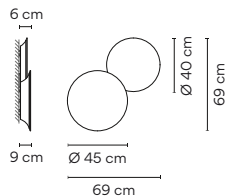

Finishes	LED temperature colour	Control
● 15/ __ Grey L2 (NCS S 2500-N)	/1_ 2700 K CRI >90 2871,9 lm 114 lm/W	5481 __ / _ 1 DALI-2
● 28/ __ Brown M1 (NCS S 4020-Y60R)	/3_ 3500 K CRI >90 3067,7 lm 121,7 lm/W	5481 __ / _ 3 1-10V
● 72/ __ Grey D1 & Grey L2		5481 __ / _ 4 Triac
		5481 __ / _ 5 Push
		5481 __ / _ Z Casambi

Finishes	LED temperature colour	Control
● 71/ __ Grey Felt L1 & Grey Felt D1	/1_ 2700 K CRI >90 2871,9 lm 114 lm/W	5481 __ / _ 1 DALI-2
● 76/ __ Grey Felt L1	/3_ 3500 K CRI >90 3067,7 lm 121,7 lm/W	5481 __ / _ 3 1-10V
		5481 __ / _ 4 Triac
		5481 __ / _ 5 Push
		5481 __ / _ Z Casambi

Materials

Diffuser: Polycarbonate. Shade: ABS.
 Wall support: Aluminum.

Light Source and electronics

1 x LED STRIP 8,4 W 700 mA
 1 x LED STRIP 12,6 W 700 mA
 Constant Current 700 mA
 / _ 1 110~240V 50/60Hz Bi-volt
 / _ 3 110~240V 50/60Hz Bi-volt
 / _ 5 110~240V 50/60Hz Bi-volt
 / _ 4 220~240V 50/60Hz
 / _ Z 220~240V 50/60Hz

Packaging

1 Box 0,46 x 0,46 x 0,4 m
 Vol 0,0846 m³
 Gross weight 6,1 Kg Net weight 3,4 Kg



5485

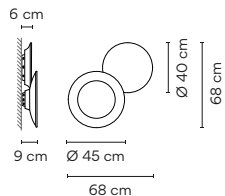

Finishes	LED temperature colour	Control
● 72/ __ Grey D1 & Grey L2	/1 _ 2700 K CRI >90 2388,4 lm 114 lm/W	5485 __ / _ 1 DALI-2
● 73/ __ Brown M1 & Grey D1)	/3 _ 3500 K CRI >90 2551,3 lm 121,5 lm/W	5485 __ / _ 3 1-10V
		5485 __ / _ 4 Triac
		5485 __ / _ 5 Push
		5485 __ / _ Z Casambi

Finishes	LED temperature colour	Control
● 71/ __ Grey Felt L1 & Grey Felt D1	/1 _ 2700 K CRI >90 2388,4 lm 114 lm/W	5485 __ / _ 1 DALI-2
	/3 _ 3500 K CRI >90 2551,3 lm 121,5 lm/W	5485 __ / _ 3 1-10V
		5485 __ / _ 4 Triac
		5485 __ / _ 5 Push
		5485 __ / _ Z Casambi

Materials

Diffuser: Polycarbonate. Shade: ABS.
Wall support: Aluminum. Ring: Steel.

Light Source and electronics

1 x LED STRIP 8,4 W 700 mA
1 x LED STRIP 12,6 W 700 mA
Constant Current 700 mA
/ _ 1 110~240V 50/60Hz Bi-volt
/ _ 3 110~240V 50/60Hz Bi-volt
/ _ 5 110~240V 50/60Hz Bi-volt
/ _ 4 220~240V 50/60Hz
/ _ Z 220~240V 50/60Hz

Packaging

1 Box 0,51 x 0,51 x 0,43 m
Vol 0,1118 m³
Gross weight 8,42 Kg Net weight 4,22 Kg



5486

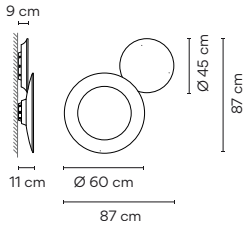

Finishes	LED temperature colour	Control
● 72/ __ Grey D1 & Grey L2	/1_ 2700 K CRI >90 2871,9 lm 114 lm/W	5486 __ / _ 1 DALI-2
● 73/ __ Brown M1 & Grey D1)	/3_ 3500 K CRI >90 3067,7 lm 121,7 lm/W	5486 __ / _ 3 1-10V
		5486 __ / _ 4 Triac
		5486 __ / _ 5 Push
		5486 __ / _ Z Casambi

Finishes	LED temperature colour	Control
● 71/ __ Grey Felt L1 & Grey Felt D1	/1_ 2700 K CRI >90 2871,9 lm 114 lm/W	5486 __ / _ 1 DALI-2
	/3_ 3500 K CRI >90 3067,7 lm 121,7 lm/W	5486 __ / _ 3 1-10V
		5486 __ / _ 4 Triac
		5486 __ / _ 5 Push
		5486 __ / _ Z Casambi

Materials

Diffuser: Polycarbonate. Shade: ABS.
 Wall support: Aluminum. Ring: Steel.

Light Source and electronics

2 x LED STRIP 12,6 W 700 mA
 Constant Current 700 mA

- / _ 1 110-240V 50/60Hz Bi-volt
- / _ 3 110-240V 50/60Hz Bi-volt
- / _ 5 110-240V 50/60Hz Bi-volt
- / _ 4 220-240V 50/60Hz
- / _ Z 220-240V 50/60Hz

Packaging

1 Box 0,66 x 0,66 x 0,5 m
 Vol 0,2178 m³
 Gross weight 11,35 Kg Net weight 5,45 Kg



5487

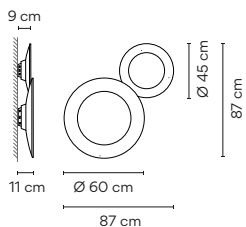

<p>Finishes</p> <ul style="list-style-type: none"> ● 21/ _ _ Black Grey (NCS S 7000-N) ● 73/ _ _ Brown M1 & Grey D1 	<p>LED temperature colour</p> <ul style="list-style-type: none"> /1 _ 2700 K CRI >90 2388,4 lm 114 lm/W /3 _ 3500 K CRI >90 2551,3 lm 121,5 lm/W 	<p>Control</p> <ul style="list-style-type: none"> 5487 _ _ / _ 1 DALI-2 5487 _ _ / _ 3 1-10V 5487 _ _ / _ 4 Triac 5487 _ _ / _ 5 Push 5487 _ _ / _ Z Casambi
--	---	--

<p>Finishes</p> <ul style="list-style-type: none"> ● 71/ _ _ Grey Felt L1 & Grey Felt D 	<p>LED temperature colour</p> <ul style="list-style-type: none"> /1 _ 2700 K CRI >90 2388,4 lm 114 lm/W /3 _ 3500 K CRI >90 2551,3 lm 121,5 lm/W 	<p>Control</p> <ul style="list-style-type: none"> 5487 _ _ / _ 1 DALI-2 5487 _ _ / _ 3 1-10V 5487 _ _ / _ 4 Triac 5487 _ _ / _ 5 Push 5487 _ _ / _ Z Casambi
--	---	--

Materials

Diffuser: Polycarbonate. Shade: ABS.
Wall support: Aluminum. Ring: Steel.

Light Source and electronics

1 x LED STRIP 8,4 W 700 mA
1 x LED STRIP 12,6 W 700 mA
Constant Current 700 mA
/ _ 1 110~240V 50/60Hz Bi-volt
/ _ 3 110~240V 50/60Hz Bi-volt
/ _ 5 110~240V 50/60Hz Bi-volt
/ _ 4 220~240V 50/60Hz
/ _ Z 220~240V 50/60Hz

Packaging

1 Box 0,66 x 0,66 x 0,5 m
Vol 0,2178 m³
Gross weight 11,52 Kg Net weight 5,62 Kg



5491

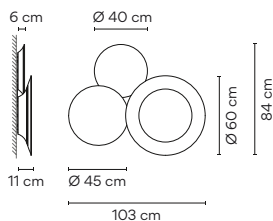

Finishes	LED temperature colour	Control
● 72/ _ _ Grey D1 & Grey L2	/1 _ 2700 K CRI >90 4307,8 lm 114 lm/W	5491 _ _ / _ 1 DALI-2
● 73/ _ _ Brown M1 & Grey D1	/3 3500 K CRI >90 4601,5 lm 121,7 lm/W	5491 _ _ / _ 3 1-10V
		5491 _ _ / _ 4 Triac
		5491 _ _ / _ 5 Push
		5491 _ _ / _ Z Casambi

Finishes	LED temperature colour	Control
● 71/ _ _ Grey Felt L1 & Grey Felt D1	/1 _ 2700 K CRI >90 4307,8 lm 114 lm/W	5491 _ _ / _ 1 DALI-2
	/3 3500 K CRI >90 4601,5 lm 121,7 lm/W	5491 _ _ / _ 3 1-10V
		5491 _ _ / _ 4 Triac
		5491 _ _ / _ 5 Push
		5491 _ _ / _ Z Casambi

Materials

Diffuser: Polycarbonate. Shade: ABS.
 Wall support: Aluminum. Ring: Steel.

Light Source and electronics

3 x LED STRIP 12,6 W 700 mA
 Constant Current 700 mA

- / _ 1 110-240V 50/60Hz Bi-volt
- / _ 3 110-240V 50/60Hz Bi-volt
- / _ 5 110-240V 50/60Hz Bi-volt
- / _ 4 220-240V 50/60Hz
- / _ Z 220-240V 50/60Hz

Packaging

1 Box 0,66 x 0,66 x 0,67 m
 Vol 0,2919 m³
 Gross weight 14,85 Kg Net weight 7,35 Kg



Mayfair Mini

Design by Diego Fortunato

Mayfair is a modern reimagining of the traditional 19th-century lights, distinguished by its timeless design and sleek silhouette.

Table



Portable

5495



5496



5497

5495

Finishes

- 23 Warm White (NCS S 0502-Y50R)
- 25 Beige D1 (NCS S 4005-Y50R)
- 37 Terra Red (NCS S 4040-Y70R)
- 47 Green L1 (NCS S 6005-G80Y)

LED temperature colour

/1_ 2700 K  CRI >90 223 lm 86 lm/W

Control

5495 __ / __ 6
Touch sensor

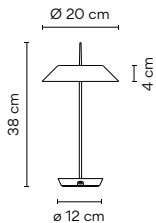

Materials

Base and shade: Polycarbonate. Diffuser: Translucent polycarbonate. Stem: Stainless steel.

Light Source and electronics

1 x LED PLATE 5V 2,5 W
Constant Voltage 5V
100~240V 50/60Hz

Packaging

1 Box 0,25 x 0,26 x 0,50 m
Vol 0,033 m³
Gross weight 1,62 Kg Net weight 0,73 Kg

Notes

Rechargeable battery autonomy:
6h at 100% Intensity.
12h at 50% Intensity.
18h at 25% Intensity.

USB-C cable: length 1,20 m
(from the base to the USB charger).

5496

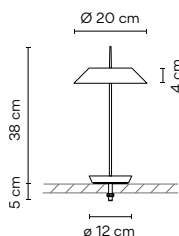

Finishes

- 23 Warm White (NCS S 0502-Y50R)
- 25 Beige D1 (NCS S 4005-Y50R)
- 37 Terra Red (NCS S 4040-Y70R)
- 47 Green L1 (NCS S 6005-G80Y)

LED temperature colour

/1_ 2700 K CRI >90 223 lm 86 lm/W

Control

5496 _ _ / _ 6
 Touch sensor

Materials

Base and shade: Polycarbonate. Diffuser: Translucent polycarbonate. Stem: Stainless steel.

Light Source and electronics

1 x LED PLATE 5V 2,5 W
 Constant Voltage 5V
 100~240V 50/60Hz

Packaging

1 Box 0,25 x 0,26 x 0,50 m
 Vol 0,033 m³
 Gross weight 1,84 Kg Net weight 0,94 Kg

Notes

Cable length: 1 m
 (from the base to the USB charger)



5497

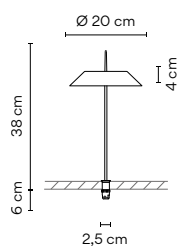

Finishes

- 23 Warm White (NCS S 0502-Y50R)
- 25 Beige D1 (NCS S 4005-Y50R)
- 37 Terra Red (NCS S 4040-Y70R)
- 47 Green L1 (NCS S 6005-G80Y)

LED temperature colour

/1_ 2700 K CRI >90 223 lm 86 lm/W

Control

5497 _ _ / _ 0
 On/ Off
 5497 _ _ / _ 1
 DALI
 5497 _ _ / _ 3
 1-10V

Materials

Base and shade: Polycarbonate. Diffuser: Translucent polycarbonate. Stem: Stainless steel.

Light Source and electronics

1 x LED PLATE 5V 2,5 W
 Constant Voltage 5V
 100~240V 50/60Hz

Packaging

1 Box 0,25 x 0,26 x 0,50 m
 Vol 0,033 m³
 Gross weight 1,45 Kg Net weight 0,54 Kg

Notes

Cable length: 1 m. (the cable connects directly to the remote driver)



Mayfair

Design by Diego Fortunato

Mayfair is a modern reimagining of the traditional 19th-century lights, distinguished by its timeless design and sleek silhouette.

Table Floor

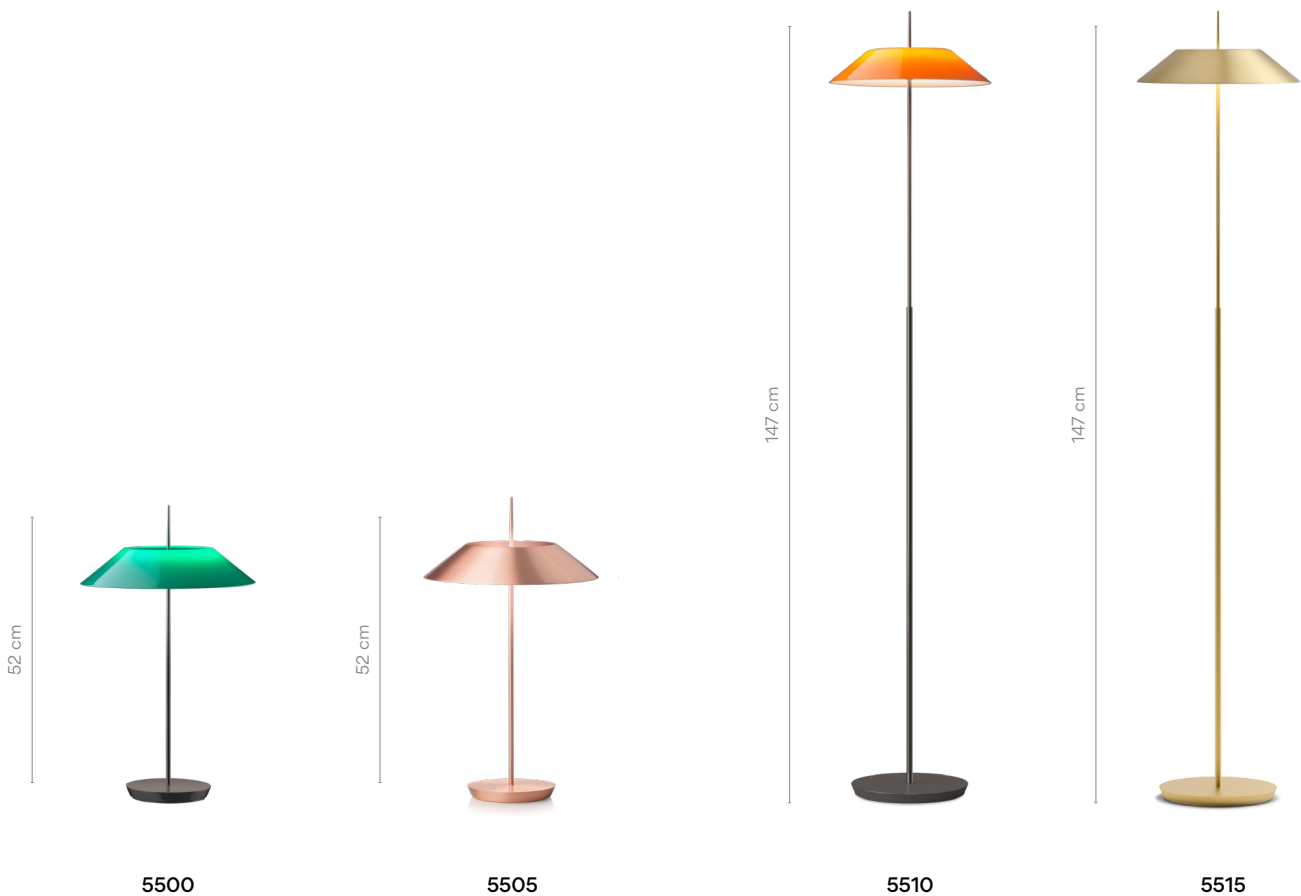

5500

- Finishes
- 07/ __ Graphite and green (RAL 7016, RAL 6026)
 - 08/ __ Graphite and orange (RAL 7016, RAL 2009)

LED temperature colour
/1_ 2700 K 
CRI >90 2027,0 lm 135 lm/W

Control
5500 __ / __ 6
Optical sensor

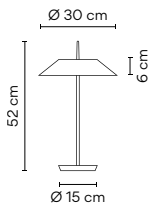

Materials
Diffuser: Polycarbonate. Shade: Methacrylate.
Tube: Steel. Base: Zamak.

Light Source and electronics
1 x LED STRIP 24V 2,4 W
1 x LED STRIP 24V 12,6 W
Constant Voltage 24V
100-240V 50/60Hz

Packaging
1 Box 0,22 x 0,35 x 0,61 m
Vol 0,0470 m³
Gross weight 3,6 Kg Net weight 3,4 Kg

Notes
Touch dimmer on base. Electric cable 2 m.
Ask if you require Push without memory (hotel room type)

LED  IP20   
Dimmer  Bi-volt

5505

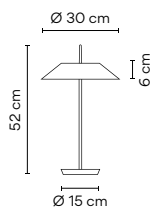

- Finishes
- 18/ __ Graphite (RAL 7016)
 - 93/ __ White (RAL 9016)

Finish customization
 (Available options:
 Vibia colour palette)

LED temperature colour
 /1_ 2700 K
 CRI >90 2027,0 lm 135 lm/W

Control
 5505 __ / _ 6
 Optical sensor

- Finishes
- 20/ __ Gold
 - 67/ __ Copper

LED temperature colour
 /1_ 2700 K
 CRI >90 2027,0 lm 135 lm/W

Control
 5505 __ / _ 6
 Optical sensor

Materials

Diffuser: Polycarbonate. Shade and tube: Steel.
 Base: Zamak.

Light Source and electronics

1 x LED STRIP 24V 2,4 W
 1 x LED STRIP 24V 12,6 W
 Constant Voltage 24V
 100~240V 50/60Hz

Packaging

1 Box 0,22 x 0,35 x 0,61 m
 Vol 0,0470 m³
 Gross weight 3,6 Kg Net weight 3,4 Kg

Notes

Touch dimmer on base. Electric cable 2 m





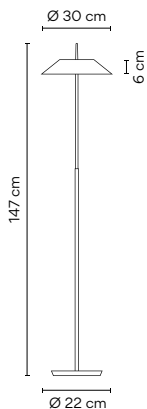

LED IP20

Dimmer Bi-volt









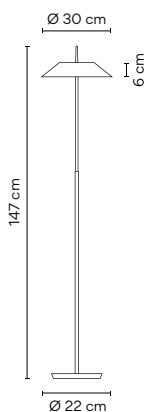

5510



Finishes ● 07/ __ Graphite and green (RAL 7016, RAL 6026) ● 08/ __ Graphite and orange (RAL 7016, RAL 2009)	LED temperature colour /1_ 2700 K  CRI >90 2027,0 lm 135 lm/W	Control 5510 __ / __ 6 Optical sensor
Materials Diffuser: Polycarbonate. Shade: Methacrylate. Tube: Steel. Base: Zamak.	Packaging 1 Box 1,50 x 0,32 x 0,34 m Vol 0,1630 m ³ Gross weight 12,8 Kg Net weight 6,2 Kg	
Light Source and electronics 1 x LED STRIP 24V 2,4 W 1 x LED STRIP 24V 12,6 W Constant Voltage 24V 100~240V 50/60Hz	Notes Touch dimmer on shade. Electric cable 2 m	
LED  IP20    Dimmer  Bi-volt 		

5515



Finishes ● 18/ __ Graphite (RAL 7016) ● 93/ __ White (RAL 9016)	LED temperature colour /1_ 2700 K  CRI >90 2027,0 lm 135 lm/W	Control 5515 __ / __ 6 Optical sensor
Finish customization (Available options: Vibia colour palette)	Packaging 1 Box 1,50 x 0,32 x 0,34 m Vol 0,1630 m ³ Gross weight 12,8 Kg Net weight 6,2 Kg	
Finishes ● 20/ __ Gold ● 67/ __ Copper	LED temperature colour /1_ 2700 K  CRI >90 2027,0 lm 135 lm/W	Control 5515 __ / __ 6 Optical sensor
Materials Diffuser: Polycarbonate. Shade and tube: Steel. Base: Zamak.	Notes Touch dimmer on shade. Electric cable 2 m	
Light Source and electronics 1 x LED STRIP 24V 2,4 W 1 x LED STRIP 24V 12,6 W Constant Voltage 24V 100~240V 50/60Hz	LED  IP20    Dimmer  Bi-volt 	



Pendants



Ø 30 cm

Ø 30 cm

5520

5525

5520

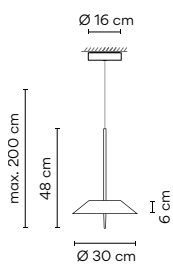

- Finishes**
- 07/ __ Graphite and green (RAL 7016. RAL 6026)
 - 08/ __ Graphite and orange (RAL 7016. RAL 2009)

LED temperature colour
 /1_ 2700 K
 CRI >90 2027,0 lm 135 lm/W

Control
 5520 __ / _ 1
 DALI

5520 __ / _ B
 1-10V, Push

5520 __ / _ Z
 Casambi

Materials
 Diffuser: Polycarbonate. Shade: Methacrylate.
 Tube and canopy: Steel.

Light Source and electronics
 1 x LED STRIP 24V 2,4 W
 1 x LED STRIP 24V 12,6 W
 Constant Voltage 24V
 220~240V 50/60Hz

Packaging
 1 Box 0,50 x 0,31 x 0,31 m
 Vol 0,0500 m³
 Gross weight 2,8 Kg Net weight 1,8 Kg

Notes
 Extra cable length.

LED IP20 CE EAC

Electrical connection
 Surface
 _18 Free Wire
 _23 Built-in
 _31 Remote
 Micro
 for plaster
 ceilings
 _32 Remote
 XXS
 for all types
 of drop
 ceilings



5525

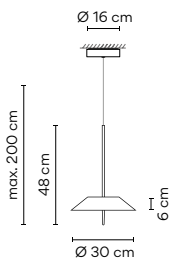

Finishes
 ● 18/ __ Graphite (RAL 7016)
 ● 93/ __ White (RAL 9016)

Finish customization
 (Available options: Vibia colour palette)

Finishes
 ● 20/ __ Gold
 ● 67/ __ Copper

LED temperature colour
 /1 _ 2700 K
 CRI >90 2027,0 lm 135 lm/W

LED temperature colour
 /1 _ 2700 K
 CRI >90 2027,0 lm 135 lm/W

Control
 5525 __ / _ 1
 DALI

5525 __ / _ B
 1-10V, Push

5525 __ / _ Z
 Casambi

Control
 5525 __ / _ 1
 DALI

5525 __ / _ B
 1-10V, Push

5525 __ / _ Z
 Casambi

Materials
 Diffuser: Polycarbonate.
 Shade, tube and canopy: Steel.

Light Source and electronics
 1 x LED STRIP 24V 2,4 W
 1 x LED STRIP 24V 12,6 W
 Constant Voltage 24V
 220-240V 50/60Hz

Packaging
 1 Box 0,50 x 0,31 x 0,31 m
 Vol 0,0500 m³
 Gross weight 2,9 Kg Net weight 1,9 Kg

Notes
 Extra cable length.

Electrical connection
 Surface
 _18 Free Wire
 _23 Built-in
 _31 Remote Micro for plaster ceilings
 _32 Remote XXS for all types of drop ceilings

Composing pendants

Next sketches are composed by one or more compositions

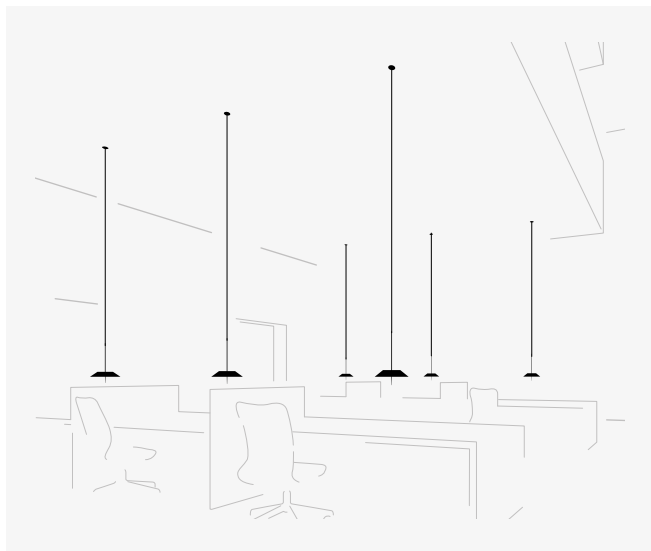

6 x 5520.

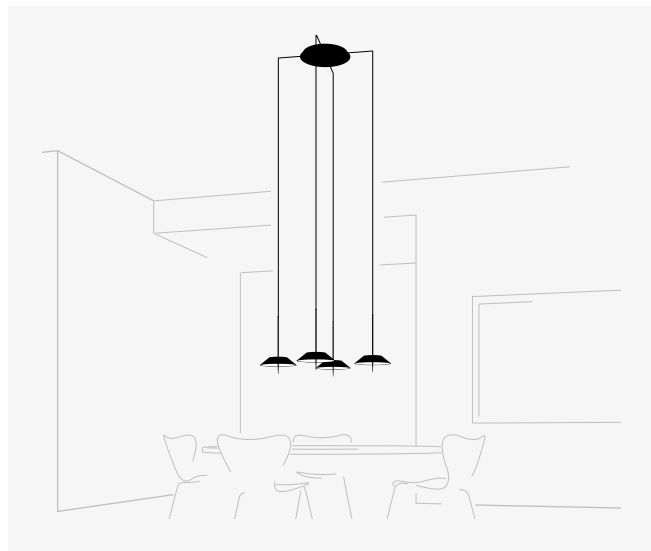

4 x 5525.

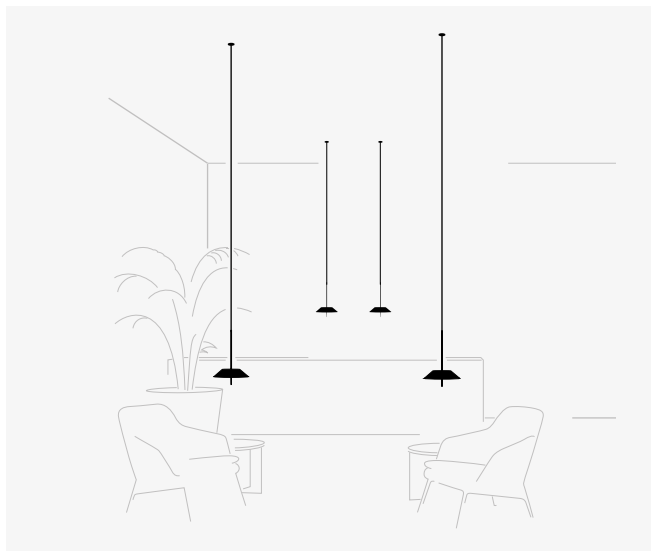

4 x 5525.

Each project is unique.
Visit vibia.com and
chose among multiple
compositions designed
and adapted to your
project needs.

Personalise your own
Mayfair composition quick
and easy at vibia.com

Electrical connection options for models 5520 / 5525

Choose your preferred installation option according to your needs. For each composition, the optimal minimum number of drivers will be delivered.

Drop ceiling

The innovative remote and built-in fittings accentuate the silkiness and lightness of compositions on suspended ceilings, its great visual grandeur taking center stage.

For Ref. 5520 / 5525

Remote

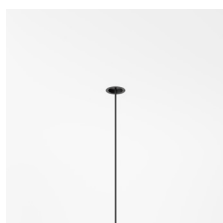

Micro ø 3 cm
height 7 cm
for plaster ceilings.
Black finish.

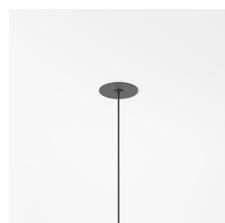
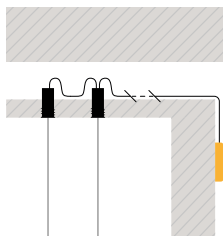

XXS ø 6 cm
height 6 cm
for all types of drop ceilings. Match with fixture finish.

Built-in



ø 8 cm
height 6 cm
match with fixture finish.

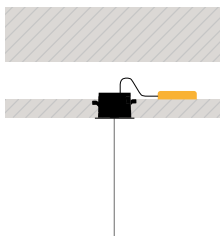

Regular ceiling

When architecture does not allow for performance, surface and free wire showcase possibilities for any need or desire with no limits, ideal for both individual or cluster arrangements.

For Ref. 5520 / 5525

Surface



ø 16 cm

match with
fixture finish.

Free Wire

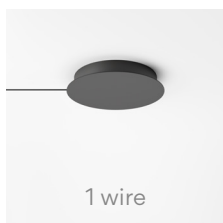

1 wire

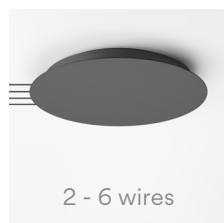

2 - 6 wires

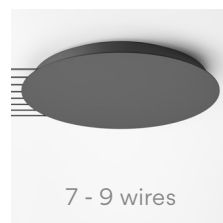

7 - 9 wires

ø 20 cm

ø 36 cm

ø 40 cm

you can choose the finish of the canopy
among black, white or any colour
matching one of the pendants.

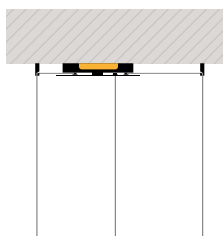
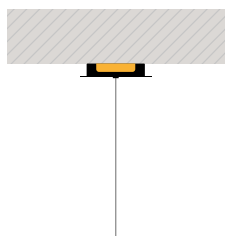

Africa

Design by Francisco Gomez Paz

An object of desire, Africa is a unique gift that combines richness of form and materiality with high performance lighting capabilities. A holistic exploration of beauty, functionality and the essence of humanity.

Table



5580

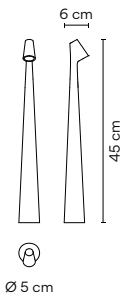

- Finishes**
- 24/ __ Beige M1 (NCS S 2005-Y50R)
 - 25/ __ Beige D1 (NCS S 4005-Y50R)
 - 29/ __ Brown D1 (NCS S 8005-Y50R)
 - 38/ __ Terra Dark (NCS S 5040-Y70R)

LED temperature colour
/1_ 2700 K 
CRI >90 520 lm 117 lm/W

Control
5580 __ / _ 5
Push

Materials
Body: Aluminium.
Diffuser: Polycarbonate

Light Source and electronics
1 x LED 4,5W 500 mA
Output: DC 5.0 V 2.0 A 10.0W
Input: 100~240V 50/60Hz

Packaging
1 Box 0,08 m x 0,53 m
Vol 0,0026 m³
Gross weight 1,23 Kg Net weight 0,9 Kg

Notes
Battery capacity 10,000mAh.
Battery voltage 3,7V.
Rechargeable battery autonomy:
6,5h at 100% Intensity.
10h at 66% Intensity.
20h at 33% Intensity.



5585

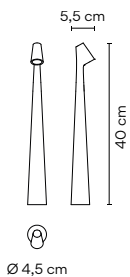

Finishes

- 24/ _ _ Beige M1
(NCS S 2005-Y50R)
- 25/ _ _ Beige D1
(NCS S 4005-Y50R)
- 29/ _ _ Brown D1
(NCS S 8005-Y50R)
- 38/ _ _ Terra Dark
(NCS S 5040-Y70R)

LED temperature colour

/1_ 2700 K
 CRI >90 520 lm 117 lm/W

Control

5585 _ _ / _ 5
 Push

Materials

Body: Aluminium.
 Diffuser: Polycarbonate

Light Source and electronics

1 x LED 4,5W 500 mA
 Output: DC 5.0 V 2.0 A 10.0W
 Input: 100~240V 50/60Hz

Packaging

1 Box 0,08 m x 0,53 m
 Vol 0,0026 m³
 Gross weight 1,23 Kg Net weight 0,9 Kg

Notes

Battery capacity 10.000mAh.
 Battery voltage 3,7V.
 Rechargeable battery autonomy:
 6,5h at 100% Intensity.
 10h at 66% Intensity.
 20h at 33% Intensity.

North

Design by Arik Levy

North, south, east and west are our points of references in space; we set-out, build and travel according to these coordinates.

Floor



max. 250 cm x max. 210 cm x max. 355 cm

5600



max. 270 cm x max. 270 cm x max. 355 cm

5605

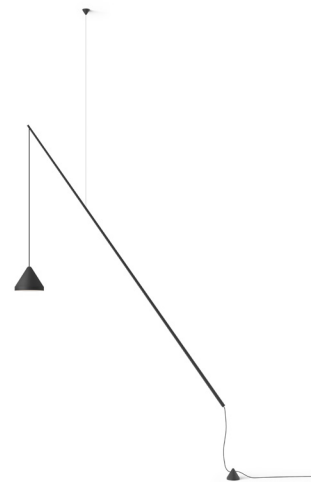

max. 210 cm x max. 310 cm x max. 130 cm

5666



max. 447 cm x max. 325 cm x max. 425 cm

5620



max. 270 cm x max. 270 cm x max. 355 cm

5625

5600

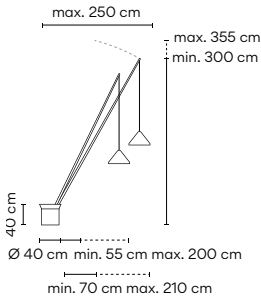

Finishes

- 10/ __ White (NCS S 0300-N)
- 11/ __ Black (NCS S 8500 N)
- 24/ __ Beige M1 (NCS S 2005-Y50R)
- 42 / __ Blue M1 (NCS S 5010-B10G)

LED temperature colour

/1_ 2700 K CRI >90 2538,0 lm 141 lm/W

Control

5600 __ / _ 5
 Push

Materials

Rods: Carbon fiber. Shade: Aluminum
 Diffuser: Methacrylate. Base: Steel.

Light Source and electronics

2 x LED 9 W 350 mA
 Constant Current 350 mA
 220~240V 50/60Hz

Packaging

10 Boxes
 Total Vol 0,37 m³
 Gross weight 92,05 Kg Net weight 79,95 Kg

Notes

Can be connected with or without plug.
 Electric cable 2,5 m.

UNTIL STOCK RUNS OUT



5605

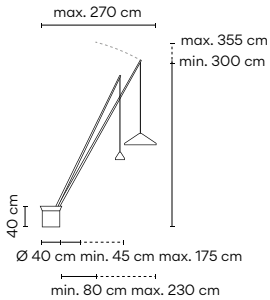

Finishes

- 10/ __ White (NCS S 0300-N)
- 11/ __ Black (NCS S 8500 N)
- 24/ __ Beige M1 (NCS S 2005-Y50R)
- 42 / __ Blue M1 (NCS S 5010-B10G)

LED temperature colour

/1_ 2700 K CRI >90 2538,0 lm 141 lm/W

Control

5605 __ / _ 5
 Push

Materials

Rods: Carbon fiber. Shade: Aluminum
 Diffuser: Methacrylate. Base: Steel.

Light Source and electronics

2 x LED 9 W 350 mA
 Constant Current 350 mA
 220~240V 50/60Hz

Packaging

10 Boxes
 Total Vol 0,35 m³
 Gross weight 91 Kg Net weight 79,8 Kg

Notes

Can be connected with or without plug.
 Electric cable 2,5 m



5620

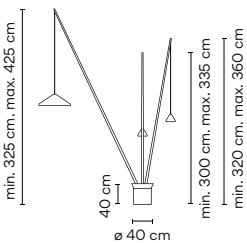

Finishes

- 10/ __ White (NCS S 0300-N)
- 11/ __ Black (NCS S 8500 N)
- 24/ __ Beige M1 (NCS S 2005-Y50R)
- 42 / __ Blue M1 (NCS S 5010-B10G)

LED temperature colour

/1_ 2700 K CRI >90 3807 lm 141 lm/W

Control

5620 __ / _ 5
 Push

Materials

Rods: Carbon fiber. Shade: Aluminum
 Diffuser: Methacrylate. Base: Steel.

Light Source and electronics

3 x LED 9W 350mA
 Constant Current 350 mA
 220~240V 50/60Hz

Packaging

12 Boxes
 Total Vol 0,36 m³
 Gross weight 94,85 Kg Net weight 81,25 Kg

Notes

Can be connected with or without plug.
 Electric cable 2,5 m



5625

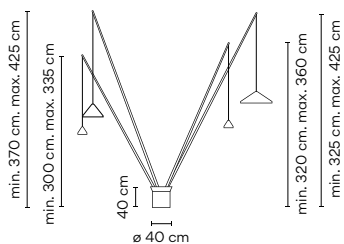

- Finishes**
- 10/ __ White (NCS S 0300-N)
 - 11/ __ Black (NCS S 8500 N)
 - 24/ __ Beige M1 (NCS S 2005-Y50R)
 - 42 / __ Blue M1 (NCS S 5010-B10G)
- LED temperature colour**
- /1 _ 2700 K
 - CRI >90 5076 lm 141 lm/W

Control
5625 __ / __ 5
 Push

Materials
 Rods: Carbon fiber. Shade: Aluminum
 Diffuser: Methacrylate. Base: Steel.

Light Source and electronics
 4 x LED 9W 350mA
 Constant Current 350 mA
 220-240V 50/60Hz

Packaging
 14 Boxes
 Total Vol 0,47 m³
 Gross weight 101,20 Kg Net weight 83,55 Kg

Notes
 Can be connected with or without plug.
 Electric cable 2,5 m.

UNTIL STOCK RUNS OUT



5666

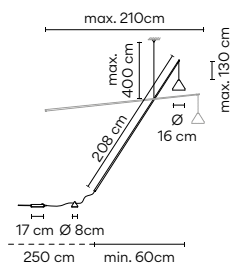

- Finishes**
- 10/ __ White (NCS S 0300-N)
 - 11/ __ Black (NCS S 8500 N)
 - 24/ __ Beige M1 (NCS S 2005-Y50R)
 - 42 / __ Blue M1 (NCS S 5010-B10G)
- LED temperature colour**
- /1 _ 2700 K
 - CRI >90 1269,0 lm 141 lm/W
 - /2 _ 3000 K
 - CRI >80 1123 lm 125 lm/W
 - /3 _ 3500 K
 - CRI >90 1374,9 lm 152,8 lm/W

Control
5666 __ / __ 5
 Push

Materials
 Rods: Carbon fiber. Shade: Aluminum
 Diffuser: Methacrylate. Counterweight: Aluminum

Light Source and electronics
 1 x LED 9 W 350 mA
 Constant Current 350 mA
 110-240V 50/60Hz

Packaging
 2 Boxes 0,24 x 0,217 x 0,21 m
 Total Vol 0,0464 m³
 Gross weight 6,2 Kg Net weight 4,05 Kg

Notes
 Electric cable with plug.
 Electric cable 2,5 m
 Extra cable length.

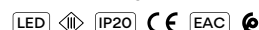

Dimmer **Bi-volt**



Height-adjustable shade.



Adjustable-angle rods.
 Can be connected with or without plug.



North

Wall



5630



5635



ø 16 cm

5640



ø 40 cm

5642



ø 60 cm

5644

5630

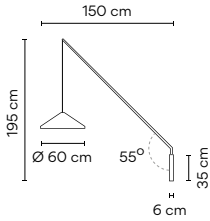

Finishes	LED temperature colour
● 10/ __ White (NCS S 0300-N)	/1 _ 2700 K CRI >90 1269,0 lm 141 lm/W
● 11/ __ Black (NCS S 8500 N)	/2 _ 3000 K CRI >80 1123 lm 125 lm/W
● 24/ __ Beige M1 (NCS S 2005-Y50R)	/3 _ 3500 K CRI >90 1374,9 lm 152,8 lm/W
● 42 / __ Blue M1 (NCS S 5010-B10G)	

Materials
 Rods: Carbon fiber. Shade: Aluminum
 Diffuser: Methacrylate. Wall Plate: Steel.

Light Source and electronics
 1 x LED 9 W 350 mA
 Constant Current 350 mA
 110-240V 50/60Hz

Control
 5630 __ / _ 5
 Push

Packaging
 3 Boxes
 Total Vol 0,24 m³
 Gross weight 11,05 Kg Net weight 5,85 Kg

Notes
 Push-button on the wall plate.
 Can be connected with or without plug.
 Electric cable 2,5 m



5635

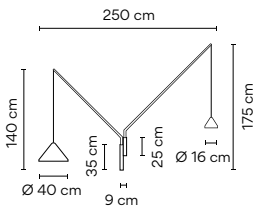

Finishes	LED temperature colour
● 10/ __ White (NCS S 0300-N)	/1 _ 2700 K CRI >90 2538,0 lm 141 lm/W
● 11/ __ Black (NCS S 8500 N)	/2 _ 3000 K CRI >80 2246 lm 125 lm/W
● 24/ __ Beige M1 (NCS S 2005-Y50R)	/3 _ 3500 K CRI >90 2749,8 lm 152,8 lm/W
● 42 / __ Blue M1 (NCS S 5010-B10G)	

Materials
 Rods: Carbon fiber. Shade: Aluminum
 Diffuser: Methacrylate. Wall Plate: Steel.

Light Source and electronics
 2 x LED 9 W 350 mA
 Constant Current 350 mA
 220-240V 50/60Hz

Control
 5635 __ / _ 5
 Push

Packaging
 4 Boxes
 Total Vol 0,18 m³
 Gross weight 14,6 Kg Net weight 7,3 Kg

Notes
 Push-button on the wall plate.
 Can be connected with or without plug.
 Electric cable 2,5 m.

UNTIL STOCK RUNS OUT



5640

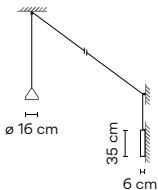

Finishes	LED temperature colour
● 10/ __ White (NCS S 0300-N)	/1 _ 2700 K CRI >90 1269 lm 141 lm/W
● 11/ __ Black (NCS S 8500 N)	
● 24/ __ Beige M1 (NCS S 2005-Y50R)	
● 42 / __ Blue M1 (NCS S 5010-B10G)	

Materials
 Diffuser: Methacrylate. Shade: Aluminum.
 Wall Plate: Steel.

Light Source and electronics
 1 x LED 9W 350 mA
 Constant Current 350 mA
 110-240V 50/60Hz

Control
 5640 __ / _ 5
 Push

Packaging
 2 Boxes
 Total Vol 0,04 m³
 Gross weight 5,2 Kg Net weight 2,75 Kg

Notes
 Push-button on the wall plate.
 Can be connected with or without plug.
 Electric cable 2,5 m.

UNTIL STOCK RUNS OUT



5642

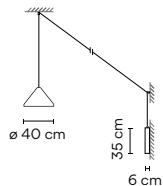

Finishes	LED temperature colour	Control
<ul style="list-style-type: none"> ● 10/ __ White (NCS S 0300-N) ● 11/ __ Black (NCS S 8500 N) ● 24/ __ Beige M1 (NCS S 2005-Y50R) ● 42 / __ Blue M1 (NCS S 5010-B10G) 	/1_ 2700 K  CRI >90 1269 lm 141 lm/W	5642 __ / _ 5 Push

Materials
 Diffuser: Methacrylate. Shade: Aluminum.
 Wall Plate: Steel.

Light Source and electronics
 1 x LED 9W 350 mA
 Constant Current 350 mA
 110-240V 50/60Hz

Packaging
 2 Boxes
 Total Vol 0,12 m³
 Gross weight 7,7 Kg Net weight 3,75 Kg

Notes
 Push-button on the wall plate.
 Length of light electric cable 10 m.
 Can be connected with or without plug.
 Electric cable 2,5 m.

UNTIL STOCK RUNS OUT



5644

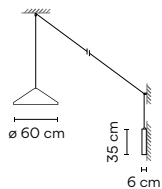

Finishes	LED temperature colour	Control
<ul style="list-style-type: none"> ● 10/ __ White (NCS S 0300-N) ● 11/ __ Black (NCS S 8500 N) ● 24/ __ Beige M1 (NCS S 2005-Y50R) ● 42 / __ Blue M1 (NCS S 5010-B10G) 	/1_ 2700 K  CRI >90 1269 lm 141 lm/W	5644 __ / _ 5 Push

Materials
 Diffuser: Methacrylate. Shade: Aluminum.
 Wall Plate: Steel.

Light Source and electronics
 1 x LED 9W 350 mA
 Constant Current 350 mA
 110-240V 50/60Hz

Packaging
 2 Boxes
 Total Vol 0,20 m³
 Gross weight 9,15 Kg Net weight 4,45 Kg

Notes
 Push-button on the wall plate.
 Length of light electric cable 10 m.
 Can be connected with or without plug.
 Electric cable 2,5 m.

UNTIL STOCK RUNS OUT



Height-adjustable shade.



Can be connected with or without plug.



Pendants



ø 16 cm

5660

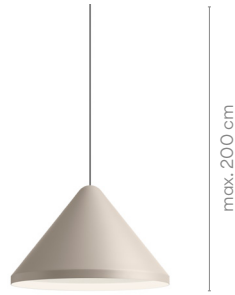

ø 40 cm

5662



ø 60 cm

5664

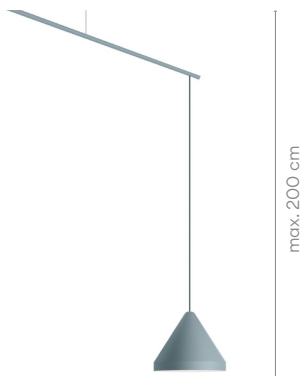

ø 16 cm

5670

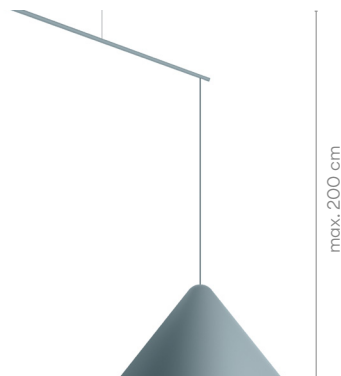

ø 40 cm

5672

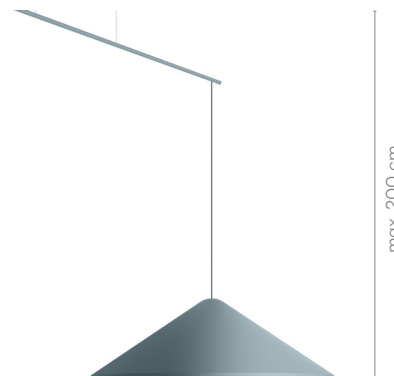

ø 60 cm

5674



Height-adjustable shade.

5660

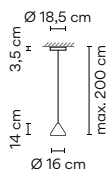

- Finishes**
- 10/ __ White (NCS S 0300-N)
 - 11/ __ Black (NCS S 8500 N)
 - 24/ __ Beige M1 (NCS S 2005-Y50R)
 - 42 / __ Blue M1 (NCS S 5010-B10G)
- LED temperature colour**
- /1 _ 2700 K
 - /2 _ 3000 K
 - /3 _ 3500 K
- Finish customization**
 (Available options: Vibia colour palette)

Materials
 Shade: Aluminum
 Diffuser: Methacrylate. Canopy: Steel.

Light Source and electronics
 1 x LED 9 W 350 mA
 Constant Current 350 mA
 110-240V 50/60Hz

Control
 5660 __ / _ 1 DALI-2
 5660 __ / _ B 1-10V, Push
 5660 __ / _ Z Casambi

Packaging
 1 Box 0,24 x 0,217 x 0,217 m
 Vol 0,01 m³
 Gross weight 2,3 Kg Net weight 1,25 Kg

Notes
 Extra cable length.



Electrical connection
 Surface
 _18 Free Wire
 _23 Built-in
 _31 Remote Micro for plaster ceilings
 _32 Remote XXS for all types of drop ceilings

5662

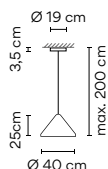

- Finishes**
- 10/ __ White (NCS S 0300-N)
 - 11/ __ Black (NCS S 8500 N)
 - 24/ __ Beige M1 (NCS S 2005-Y50R)
 - 42 / __ Blue M1 (NCS S 5010-B10G)
- LED temperature colour**
- /1 _ 2700 K
 - /2 _ 3000 K
 - /3 _ 3500 K
- Finish customization**
 (Available options: Vibia colour palette)

Materials
 Shade: Aluminum
 Diffuser: Methacrylate. Canopy: Steel.

Light Source and electronics
 1 x LED 9 W 350 mA
 Constant Current 350 mA
 220-240V 50/60Hz

Control
 5662 __ / _ 1 DALI-2
 5662 __ / _ B 1-10V, Push
 5662 __ / _ Z Casambi

Packaging
 1 Box 0,36 x 0,537 x 0,537 m
 Vol 0,10 m³
 Gross weight 4,8 Kg Net weight 2,25 Kg

Notes
 Extra cable length.



Electrical connection
 Surface
 _18 Free Wire
 _23 Built-in
 _31 Remote Micro for plaster ceilings
 _32 Remote XXS for all types of drop ceilings

5664

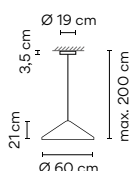

- Finishes**
- 10/ __ White (NCS S 0300-N)
 - 11/ __ Black (NCS S 8500 N)
 - 24/ __ Beige M1 (NCS S 2005-Y50R)
 - 42 / __ Blue M1 (NCS S 5010-B10G)
- LED temperature colour**
- /1 _ 2700 K
 - /2 _ 3000 K
 - /3 _ 3500 K
- Finish customization**
 (Available options: Vibia colour palette)

Materials
 Shade: Aluminum
 Diffuser: Methacrylate. Canopy: Steel.

Light Source and electronics
 1 x LED 9 W 350 mA
 Constant Current 350 mA
 110-240V 50/60Hz

Control
 5664 __ / _ 1 DALI-2
 5664 __ / _ B 1-10V, Push
 5664 __ / _ Z Casambi

Packaging
 1 Box 0,32 x 0,727 x 0,727 m
 Vol 0,17 m³
 Gross weight 6,25 Kg Net weight 2,95 Kg

Notes
 Extra cable length.



Electrical connection
 Surface
 _18 Free Wire
 _23 Built-in
 _31 Remote Micro for plaster ceilings
 _32 Remote XXS for all types of drop ceilings

5670

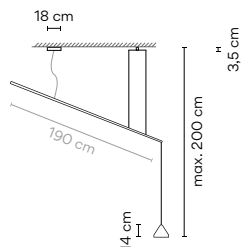

Finishes

- 10/ _ _ White (NCS S 0300-N)
- 11/ _ _ Black (NCS S 8500 N)
- 24/ _ _ Beige M1 (NCS S 2005-Y50R)
- 42 / _ _ Blue M1 (NCS S 5010-B10G)

LED temperature colour

- /1_ 2700 K CRI >90 1269,0 lm 141 lm/W
- /2_ 3000 K CRI >80 1123 lm 125 lm/W
- /3_ 3500 K CRI >90 1374,9 lm 152,8 lm/W

Control

5670 _ _ / _ 1
DALI-2

5670 _ _ / _ B
1-10V, Push

5670 _ _ / _ Z
Casambi

Materials

Rods: Carbon fiber. Shade: Aluminum
Diffuser: Methacrylate. Canopy: Steel.

Light Source and electronics

1 x LED 9 W 350 mA
Constant Current 350 mA
110-240V 50/60Hz

Packaging

2 Boxes
Total Vol 0,06 m³
Gross weight 5,75 Kg Net weight 2 Kg

Notes

Extra cable length.



5672

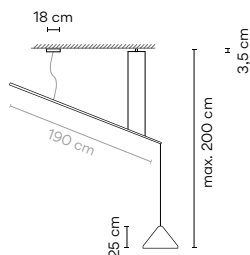

Finishes

- 10/ _ _ White (NCS S 0300-N)
- 11/ _ _ Black (NCS S 8500 N)
- 24/ _ _ Beige M1 (NCS S 2005-Y50R)
- 42 / _ _ Blue M1 (NCS S 5010-B10G)

LED temperature colour

- /1_ 2700 K CRI >90 1269,0 lm 141 lm/W
- /2_ 3000 K CRI >80 1123 lm 125 lm/W
- /3_ 3500 K CRI >90 1374,9 lm 152,8 lm/W

Control

5672 _ _ / _ 1
DALI-2

5672 _ _ / _ B
1-10V, Push

5672 _ _ / _ Z
Casambi

Materials

Rods: Carbon fiber. Shade: Aluminum
Diffuser: Methacrylate. Canopy: Steel.

Light Source and electronics

1 x LED 9W 350 mA
Constant Current 350 mA
110-240V 50/60Hz

Packaging

2 Boxes
Total Vol 0,14 m³
Gross weight 8,25 Kg Net weight 3 Kg

Notes

Extra cable length.



5674

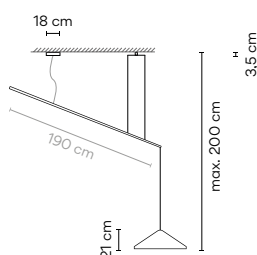

Finishes

- 10/ _ _ White (NCS S 0300-N)
- 11/ _ _ Black (NCS S 8500 N)
- 24/ _ _ Beige M1 (NCS S 2005-Y50R)
- 42 / _ _ Blue M1 (NCS S 5010-B10G)

LED temperature colour

- /1_ 2700 K CRI >90 1269,0 lm 141 lm/W
- /2_ 3000 K CRI >80 1123 lm 125 lm/W
- /3_ 3500 K CRI >90 1374,9 lm 152,8 lm/W

Control

5674 _ _ / _ 1
DALI-2

5674 _ _ / _ B
1-10V, Push

5674 _ _ / _ Z
Casambi

Materials

Rods: Carbon fiber. Shade: Aluminum
Diffuser: Methacrylate. Canopy: Steel.

Light Source and electronics

1 x LED 9 W 350 mA
Constant Current 350 mA
110-240V 50/60Hz

Packaging

2 Boxes
Total Vol 0,21 m³
Gross weight 9,7 Kg Net weight 3,7 Kg

Notes

Extra cable length.



Composing pendants

Next sketches are composed by one or more compositions

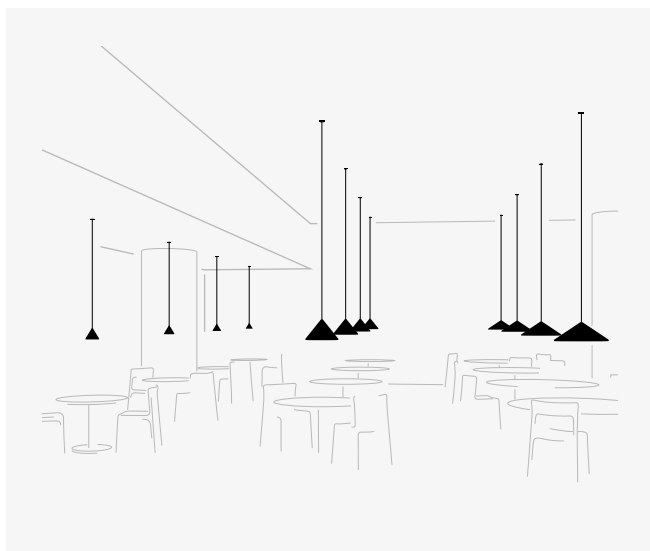

4 x 5660.
4 x 5662.
4 x 5664.

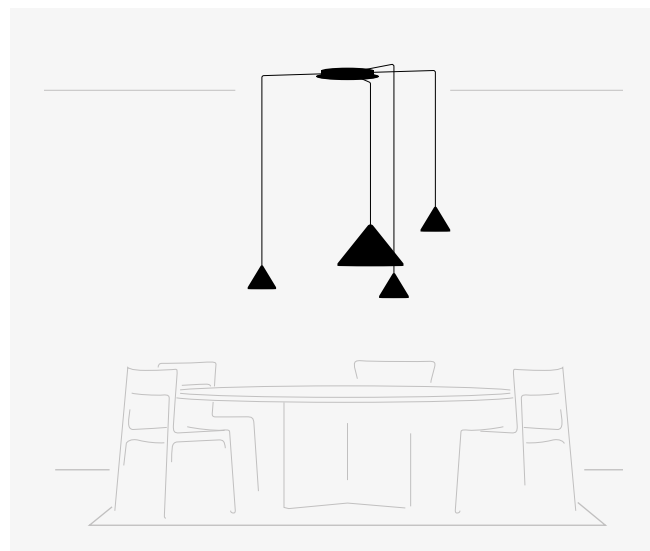

1 x 5664.
3 x 5660.

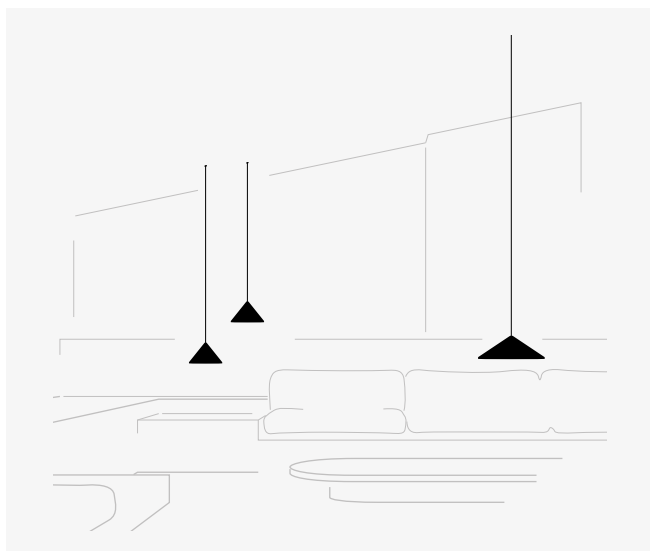

2 x 5662.
1 x 5664.

Each project is unique.
Visit vibia.com and
chose among multiple
compositions designed
and adapted to your
project needs.

Personalise your own
North composition quick
and easy at vibia.com

Electrical connection options for models 5660 / 5662 / 5664

Choose your preferred installation option
according to your needs.
For each composition, the optimal minimum
number of drivers will be delivered.

Drop ceiling

The innovative remote and built-in fittings accentuate
the silkiness and lightness of compositions on
suspended ceilings, its great visual grandeur taking
center stage.

For Ref. 5660 / 5662 / 5664

Remote

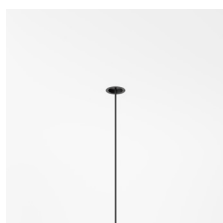

Micro \varnothing 3 cm
height 7 cm
for plaster ceilings.
Black finish.

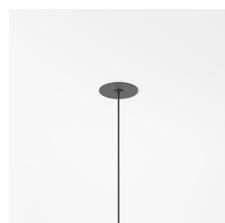
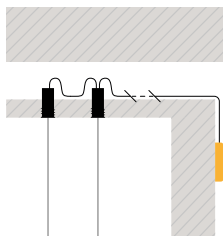

XXS \varnothing 6 cm
height 6 cm
for all types of drop
ceilings. Match with
fixture finish.



Built-in



\varnothing 8 cm
height 6 cm
match with
fixture finish.

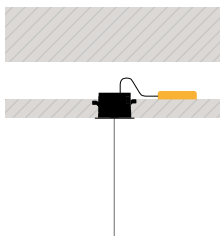

Regular ceiling

When architecture does not allow for performance, surface and free wire showcase possibilities for any need or desire with no limits, ideal for both individual or cluster arrangements.

For Ref. 5660 / 5662 / 5664

Surface

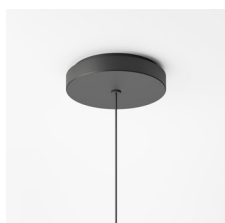

ø 18 cm

match with
fixture finish.

Free Wire

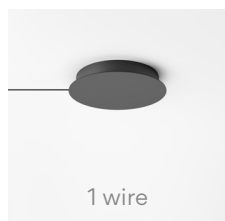

1 wire

ø 20 cm

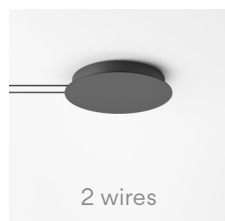

2 wires

ø 22 cm

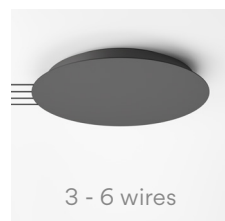

3 - 6 wires

ø 36 cm

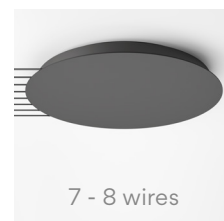

7 - 8 wires

ø 40 cm

you can choose the finish of the canopy
among black, white or any colour
matching one of the pendants.

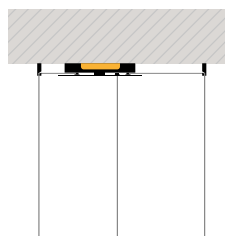
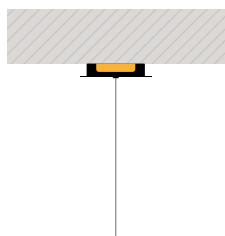

Tempo

Design by Lievore, Altherr

Timeless character. The Tempo collection by Lievore Altherr reclaims our collective memory of light, making it contemporary through its most essential expression. Shades with an architectonic profile recreate different ambiances bringing them right up-to-date with new additions and uses.

Wall



5756 5757



5758 5759



5760 5761



5762 5763



5764 5765



5766 5767

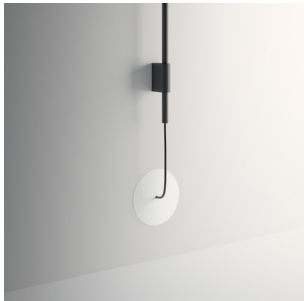

Ref.
 5757, 5759, 5761, 5763, 5765, 5767.
 Recessed dimmable driver.



Ref.
 5756, 5758, 5760, 5762, 5764, 5766.
 Push dimmer on the cable.
 With plug.

5756

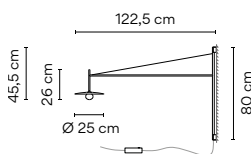

Finishes	LED temperature colour	Control
<ul style="list-style-type: none"> ● 18/ __ Graphite (ADAPTA RF9913WX) ● 37/ __ Terra Red (NCS S 4040-Y70R) ● 58/ __ Cream (RAL 7044) ● 62/ __ Green (NCS S 3010-G20Y) 	/1_ 2700 K CRI >90 415 lm 104 lm/W	5756 __ / _ 5 Push

Materials	Packaging
Diffuser: Blown-glass. LED support: Aluminum. Structures: Steel. Shade: Aluminum.	2 Boxes Total Vol 0,082 m ³ Gross weight 4,3 Kg Net weight 2,5 Kg
Light Source and electronics	Notes
1 x LED 4 W 350 mA Constant Current 350 mA 220~240V 50/60Hz	Push dimmer on the cable. With plug (4 m)

5757

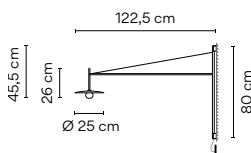

Finishes	LED temperature colour	Control
<ul style="list-style-type: none"> ● 18/ __ Graphite (ADAPTA RF9913WX) ● 37/ __ Terra Red (NCS S 4040-Y70R) ● 58/ __ Cream (RAL 7044) ● 62/ __ Green (NCS S 3010-G20Y) 	/1_ 2700 K CRI >90 415 lm 104 lm/W	5757 __ / _ 1 DALI-2 5757 __ / _ B 1-10V, Push 5757 __ / _ Z Casambi

Materials	Packaging
Diffuser: Blown-glass. LED support: Aluminum. Structures: Steel. Shade: Aluminum.	2 Boxes Total Vol 0,082 m ³ Gross weight 4,3 Kg Net weight 2,5 Kg
Light Source and electronics	Notes
1 x LED 4 W 350 mA Constant Current 350 mA 220~240V 50/60Hz	Recessed dimmable driver (2,5 m)
ø 7,5 cm	

5758

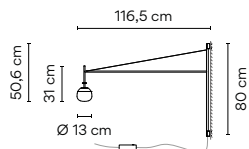

- Finishes**
- **18/** __ Graphite (ADAPTA RF9913WX)
 - **37/** __ Terra Red (NCS S 4040-Y70R)
 - **58/** __ Cream (RAL 7044)
 - **62/** __ Green (NCS S 3010-G20Y)
- LED temperature colour**
- /1_ 2700 K CRI >90 415 lm 104 lm/W

Control

5758 __ / _ 5
Push

Materials

Diffuser: Blown-glass. LED support: Aluminum.
Structures: Steel.

Light Source and electronics

1 x LED 4 W 350 mA
Constant Current 350 mA
220-240V 50/60Hz

Packaging

2 Boxes
Total Vol 0,088 m³
Gross weight 3,5 Kg Net weight 1,7 Kg

Notes

Push dimmer on the cable. With plug (4 m).



5759

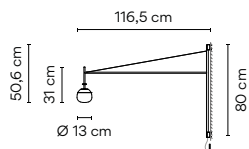

- Finishes**
- **18/** __ Graphite (ADAPTA RF9913WX)
 - **37/** __ Terra Red (NCS S 4040-Y70R)
 - **58/** __ Cream (RAL 7044)
 - **62/** __ Green (NCS S 3010-G20Y)
- LED temperature colour**
- /1_ 2700 K CRI >90 415 lm 104 lm/W

Control

5759 __ / _ 1
DALI-2

5759 __ / _ B
1-10V, Push

5759 __ / _ Z
Casambi

Materials

Diffuser: Blown-glass. LED support: Aluminum.
Structures: Steel.

Light Source and electronics

1 x LED 4 W 350 mA
Constant Current 350 mA
220-240V 50/60Hz

Packaging

2 Boxes
Total Vol 0,088 m³
Gross weight 3,5 Kg Net weight 1,7 Kg

Notes

Recessed dimmable driver (2,5 m)



5760

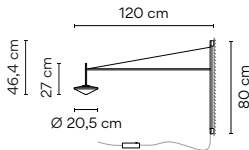

- Finishes**
- **18/** __ Graphite (ADAPTA RF9913WX)
 - **37/** __ Terra Red (NCS S 4040-Y70R)
 - **58/** __ Cream (RAL 7044)
 - **62/** __ Green (NCS S 3010-G20Y)
- LED temperature colour**
- /1_ 2700 K CRI >90 415 lm 104 lm/W

Control

5760 __ / _ 5
Push

Materials

Diffuser: Blown-glass. LED support: Aluminum.
Structures: Steel.

Light Source and electronics

1 x LED 4 W 350 mA
Constant Current 350 mA
220-240V 50/60Hz

Packaging

2 Boxes
Total Vol 0,088 m³
Gross weight 3,7 Kg Net weight 1,9 Kg

Notes

Push dimmer on the cable. With plug (4 m)



5761

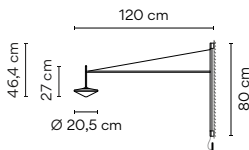

- Finishes**
- **18/** __ Graphite (ADAPTA RF9913WX)
 - **37/** __ Terra Red (NCS S 4040-Y70R)
 - **58/** __ Cream (RAL 7044)
 - **62/** __ Green (NCS S 3010-G20Y)
- LED temperature colour**
- /1_ 2700 K CRI >90 415 lm 104 lm/W

Control

5761 __ / _ 1
DALI-2

5761 __ / _ B
1-10V, Push

5761 __ / _ Z
Casambi

Materials

Diffuser: Blown-glass. LED support: Aluminum.
Structures: Steel.

Light Source and electronics

1 x LED 4 W 350 mA
Constant Current 350 mA
220-240V 50/60Hz

Packaging

2 Boxes
Total Vol 0,088 m³
Gross weight 3,7 Kg Net weight 1,9 Kg

Notes

Recessed dimmable driver (2,5 m)



5762

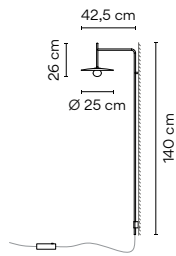

- Finishes**
- 18/ __ Graphite (ADAPTA RF9913WX)
 - 37/ __ Terra Red (NCS S 4040-Y70R)
 - 58/ __ Cream (RAL 7044)
 - 62/ __ Green (NCS S 3010-G20Y)
- LED temperature colour**
- /1_ 2700 K CRI >90 415 lm 104 lm/W

Control

5762 __ / _ 5
 Push

Materials

Diffuser: Blown-glass. LED support: Aluminum.
 Structures: Steel. Shade: Aluminum

Light Source and electronics

1 x LED 4 W 350 mA
 Constant Current 350 mA
 220~240V 50/60Hz

Packaging

2 Boxes
 Total Vol 0,088 m³
 Gross weight 3,2 Kg Net weight 2 Kg

Notes

Push dimmer on the cable. With plug (4 m)



5763

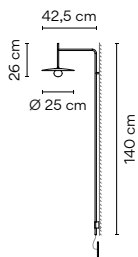

- Finishes**
- 18/ __ Graphite (ADAPTA RF9913WX)
 - 37/ __ Terra Red (NCS S 4040-Y70R)
 - 58/ __ Cream (RAL 7044)
 - 62/ __ Green (NCS S 3010-G20Y)
- LED temperature colour**
- /1_ 2700 K CRI >90 415 lm 104 lm/W

Control

5763 __ / _ 1
 DALI-2

5763 __ / _ B
 1-10V, Push

5763 __ / _ Z
 Casambi

Materials

Diffuser: Blown-glass. LED support: Aluminum.
 Structures: Steel. Shade: Aluminum

Light Source and electronics

1 x LED 4 W 350 mA
 Constant Current 350 mA
 220~240V 50/60Hz

Packaging

2 Boxes
 Total Vol 0,088 m³
 Gross weight 3,2 Kg Net weight 2 Kg

Notes

Recessed dimmable driver (2,5 m)



5764

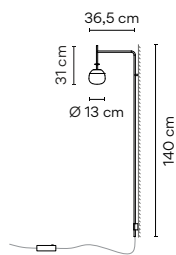

- Finishes**
- 18/ __ Graphite (ADAPTA RF9913WX)
 - 37/ __ Terra Red (NCS S 4040-Y70R)
 - 58/ __ Cream (RAL 7044)
 - 62/ __ Green (NCS S 3010-G20Y)
- LED temperature colour**
- /1_ 2700 K CRI >90 415 lm 104 lm/W

Control

5764 __ / _ 5
 Push

Materials

Diffuser: Blown-glass. LED support: Aluminum.
 Structures: Steel.

Light Source and electronics

1 x LED 4 W 350 mA
 Constant Current 350 mA
 220~240V 50/60Hz

Packaging

2 Boxes
 Total Vol 0,088 m³
 Gross weight 2,45 Kg Net weight 1,25 Kg

Notes

Push dimmer on the cable. With plug (4 m)



5765

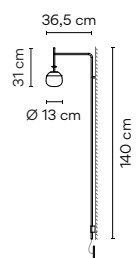

- Finishes**
- 18/ __ Graphite (ADAPTA RF9913WX)
 - 37/ __ Terra Red (NCS S 4040-Y70R)
 - 58/ __ Cream (RAL 7044)
 - 62/ __ Green (NCS S 3010-G20Y)
- LED temperature colour**
- /1_ 2700 K CRI >90 415 lm 104 lm/W

Control

5765 __ / _ 1
 DALI-2

5765 __ / _ B
 1-10V, Push

5765 __ / _ Z
 Casambi

Materials

Diffuser: Blown-glass. LED support: Aluminum.
 Structures: Steel.

Light Source and electronics

1 x LED 4 W 350 mA
 Constant Current 350 mA
 220~240V 50/60Hz

Packaging

2 Boxes
 Total Vol 0,088 m³
 Gross weight 2,45 Kg Net weight 1,25 Kg

Notes

Recessed dimmable driver (2,5 m)



5766

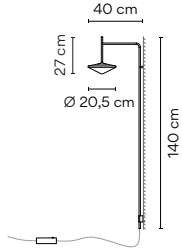

- Finishes**
- 18/ _ _ Graphite (ADAPTA RF9913WX)
 - 37/ _ _ Terra Red (NCS S 4040-Y70R)
 - 58/ _ _ Cream (RAL 7044)
 - 62/ _ _ Green (NCS S 3010-G20Y)
- LED temperature colour**
- /1_ 2700 K CRI >90 415 lm 104 lm/W

Control

5766 _ _ / _ 5
Push

Materials
Diffuser: Blown-glass. LED support: Aluminum.
Structures: Steel.

Packaging
2 Boxes
Total Vol 0,088 m³
Gross weight 2,65 Kg Net weight 1,45 Kg

Light Source and electronics
1 x LED 4 W 350 mA
Constant Current 350 mA
220~240V 50/60Hz

Notes
Push dimmer on the cable. With plug (4 m)



5767

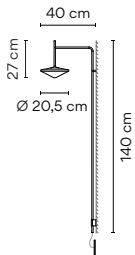

- Finishes**
- 18/ _ _ Graphite (ADAPTA RF9913WX)
 - 37/ _ _ Terra Red (NCS S 4040-Y70R)
 - 58/ _ _ Cream (RAL 7044)
 - 62/ _ _ Green (NCS S 3010-G20Y)
- LED temperature colour**
- /1_ 2700 K CRI >90 415 lm 104 lm/W

Control

5767 _ _ / _ 1
DALI-2

5767 _ _ / _ B
1-10V, Push

5767 _ _ / _ Z
Casambi

Materials
Diffuser: Blown-glass. LED support: Aluminum.
Structures: Steel.

Packaging
2 Boxes
Total Vol 0,088 m³
Gross weight 2,65 Kg Net weight 1,45 Kg

Light Source and electronics
1 x LED 4 W 350 mA
Constant Current 350 mA
220~240V 50/60Hz

Notes
Recessed dimmable driver (2,5 cm)



Pendants



ø 25 cm

5770



ø 13 cm

5772



ø 20,5 cm

5774

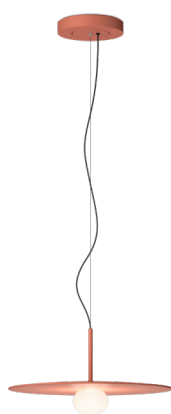

ø 40 cm

5776



ø 24 cm

5778

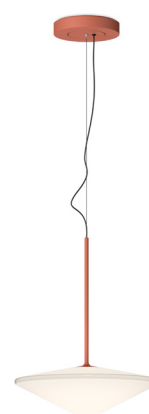

ø 34,5 cm

5780

5770

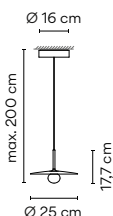

- | | |
|--|--|
| Finishes | LED temperature colour |
| <ul style="list-style-type: none"> ● 18/ Graphite (ADAPTA RF9913WX) ● 37/ Terra Red (NCS S 4040-Y70R) ● 58/ Cream (RAL 7044) ● 62/ Green (NCS S 3010-G20Y) | <ul style="list-style-type: none"> /1 2700 K CRI >90 415 lm 104 lm/W |

Materials
 Diffuser: Blown-glass. LED support: Aluminum.
 Structures: Steel. Shade: Aluminum. Canopy: Steel.

Light Source and electronics
 1 x LED 4 W 350 mA
 Constant Current 350 mA
 110-240V 50/60Hz

Control
5770 / / **_ 1**
 DALI-2

5770 / / **_ B**
 1-10V, Push

5770 / / **_ Z**
 Casambi

Packaging
 1 Box 0,28 x 0,26 x 0,13 m
 Vol 0,01 m³
 Gross weight 2,5 Kg Net weight 2 Kg

Notes
 Extra cable length.



Electrical connection
 Surface
_18 Free Wire
_23 Built-in
_31 Remote Micro for plaster ceilings
_32 Remote XXS for all types of drop ceilings

5772

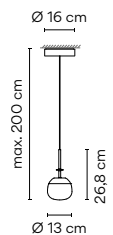

- | | |
|--|--|
| Finishes | LED temperature colour |
| <ul style="list-style-type: none"> ● 18/ Graphite (ADAPTA RF9913WX) ● 37/ Terra Red (NCS S 4040-Y70R) ● 58/ Cream (RAL 7044) ● 62/ Green (NCS S 3010-G20Y) | <ul style="list-style-type: none"> /1 2700 K CRI >90 415 lm 104 lm/W |

Materials
 Diffuser: Blown-glass. LED support: Aluminum.
 Structures: Steel. Shade: Aluminum. Canopy: Steel.

Light Source and electronics
 1 x LED 4 W 350 mA
 Constant Current 350 mA
 110-240V 50/60Hz

Control
5772 / / **_ 1**
 DALI-2

5772 / / **_ B**
 1-10V, Push

5772 / / **_ Z**
 Casambi

Packaging
 1 Box 0,28 x 0,2 x 0,27 m
 Vol 0,015 m³
 Gross weight 1,8 Kg Net weight 1,2 Kg

Notes
 Extra cable length.



Electrical connection
 Surface
_18 Free Wire
_23 Built-in
_31 Remote Micro for plaster ceilings
_32 Remote XXS for all types of drop ceilings

5774

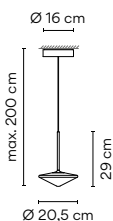

- | | |
|--|--|
| Finishes | LED temperature colour |
| <ul style="list-style-type: none"> ● 18/ Graphite (ADAPTA RF9913WX) ● 37/ Terra Red (NCS S 4040-Y70R) ● 58/ Cream (RAL 7044) ● 62/ Green (NCS S 3010-G20Y) | <ul style="list-style-type: none"> /1 2700 K CRI >90 415 lm 104 lm/W |

Materials
 Diffuser: Blown-glass. LED support: Aluminum.
 Structures: Steel. Shade: Aluminum. Canopy: Steel.

Light Source and electronics
 1 x LED 4 W 350 mA
 Constant Current 350 mA
 110-240V 50/60Hz

Control
5774 / / **_ 1**
 DALI-2

5774 / / **_ B**
 1-10V, Push

5774 / / **_ Z**
 Casambi

Packaging
 1 Box 0,28 x 0,2 x 0,27 m
 Vol 0,015 m³
 Gross weight 2 Kg Net weight 1,4 Kg

Notes
 Extra cable length.



Electrical connection
 Surface
_18 Free Wire
_23 Built-in
_31 Remote Micro for plaster ceilings
_32 Remote XXS for all types of drop ceilings

5776

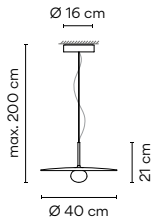

Finishes	LED temperature colour
● 18/ __ Graphite (ADAPTA RF9913WX)	/1_ 2700 K E CRI >90 415 lm 104 lm/W
● 37/ __ Terra Red (NCS S 4040-Y70R)	
● 58/ __ Cream (RAL 7044)	
● 62/ __ Green (NCS S 3010-G20Y)	

Control
5776 __ / __ 1 DALI-2
5776 __ / __ B 1-10V, Push
5776 __ / __ Z Casambi

Materials
Diffuser: Blown-glass. LED support: Aluminum.
Structures: Steel. Shade: Aluminum. Canopy: Steel.

Packaging
1 Box 0,45 x 0,45 x 0,12 m
Vol 0,023 m³
Gross weight 5,5 Kg Net weight 4 Kg

Light Source and electronics
1 x LED 4 W 350 mA
Constant Current 350 mA
110-240V 50/60Hz

Notes
Extra cable length.

5778

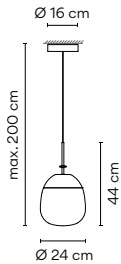

Finishes	LED temperature colour
● 18/ __ Graphite (ADAPTA RF9913WX)	/1_ 2700 K E CRI >90 415 lm 104 lm/W
● 37/ __ Terra Red (NCS S 4040-Y70R)	
● 58/ __ Cream (RAL 7044)	
● 62/ __ Green (NCS S 3010-G20Y)	

Control
5778 __ / __ 1 DALI-2
5778 __ / __ B 1-10V, Push
5778 __ / __ Z Casambi

Materials
Diffuser: Blown-glass. LED support: Aluminum.
Structure: Steel. Canopy: Steel.

Packaging
1 Box 0,33 x 0,33 x 0,42 m
Vol 0,045 m³
Gross weight 4 Kg Net weight 2,5 Kg

Light Source and electronics
1 x LED 4 W 350 mA
Constant Current 350 mA
110-240V 50/60Hz

Notes
Extra cable length.

5780

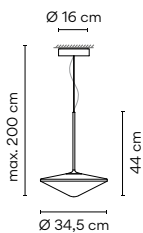

Finishes	LED temperature colour
● 18/ __ Graphite (ADAPTA RF9913WX)	/1_ 2700 K E CRI >90 415 lm 104 lm/W
● 37/ __ Terra Red (NCS S 4040-Y70R)	
● 58/ __ Cream (RAL 7044)	
● 62/ __ Green (NCS S 3010-G20Y)	

Control
5780 __ / __ 1 DALI-2
5780 __ / __ B 1-10V, Push
5780 __ / __ Z Casambi

Materials
Diffuser: Blown-glass. LED support: Aluminum.
Structures: Steel. Shade: Aluminum. Canopy: Steel.

Packaging
1 Box 0,41 x 0,41 x 0,23 m
Vol 0,038 m³
Gross weight 4 Kg Net weight 2,5 Kg

Light Source and electronics
1 x LED 4 W 350 mA
Constant Current 350 mA
110-240V 50/60Hz

Notes
Extra cable length.

Composing pendants

Next sketches are composed by one or more compositions

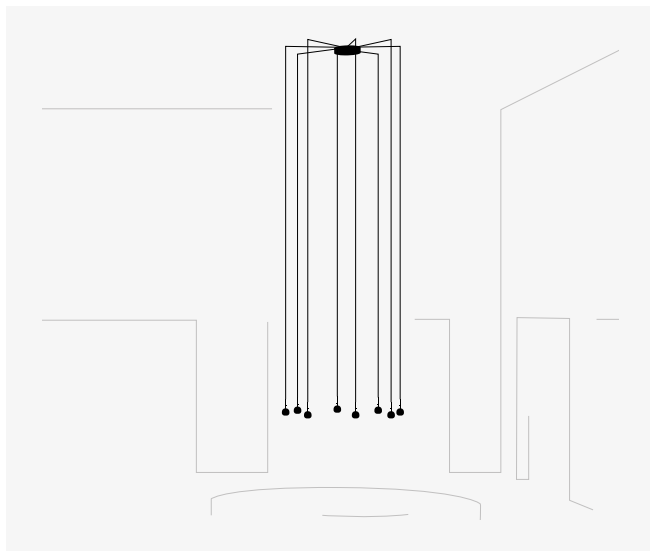

8 x 5772.

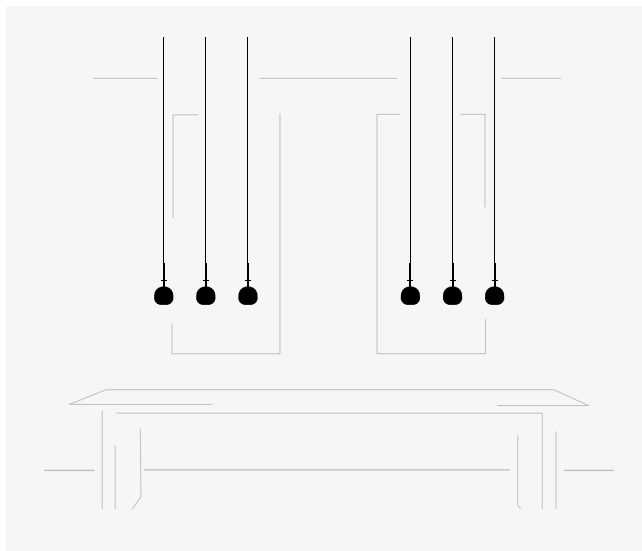

6 x 5772.

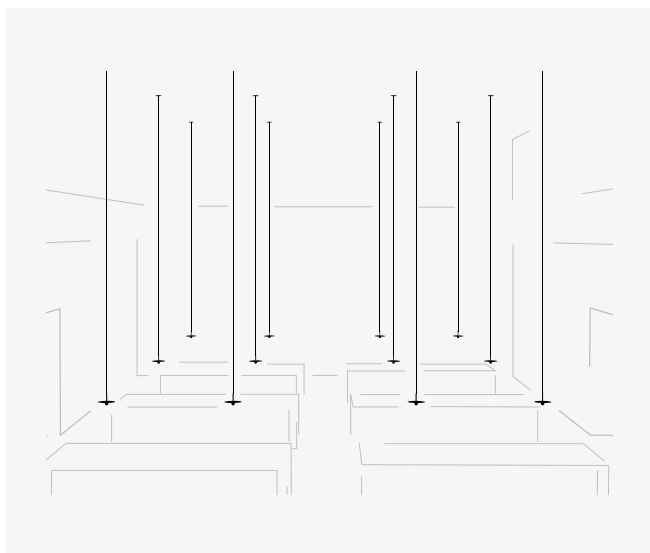

12 x 5770.

Each project is unique.
Visit vibia.com and
chose among multiple
compositions designed
and adapted to your
project needs.

Personalise your own
Tempo composition quick
and easy at vibia.com



Electrical connection options for models 5770 / 5772 / 5774

Choose your preferred installation option
according to your needs.
For each composition, the optimal minimum
number of drivers will be delivered.

Drop ceiling

The innovative remote and built-in fittings accentuate
the silkiness and lightness of compositions on
suspended ceilings, its great visual grandeur taking
center stage.

For Ref. 5770 / 5772 / 5774

Remote

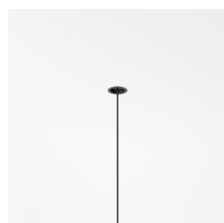

Micro \varnothing 3 cm
height 7 cm
for plaster ceilings.
Black finish.

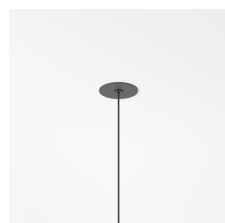
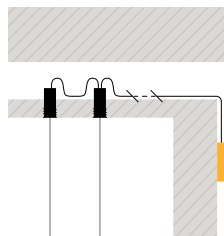

XXS \varnothing 6 cm
height 6 cm
for all types of drop
ceilings. Match with
fixture finish.

Built-in



\varnothing 8 cm
height 6 cm
match with
fixture finish.

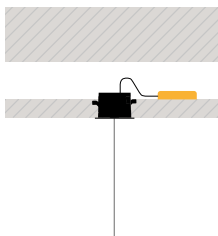

Regular ceiling

When architecture does not allow for performance, surface and free wire showcase possibilities for any need or desire with no limits, ideal for both individual or cluster arrangements.

For Ref. 5770 / 5772 / 5774

Surface



ø 16 cm

match with
fixture finish.

Free Wire

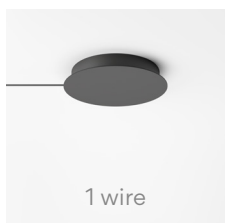

1 wire

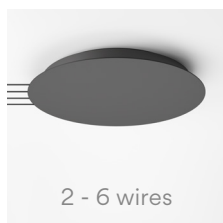

2 - 6 wires

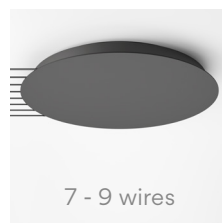

7 - 9 wires

ø 20 cm

ø 36 cm

ø 40 cm

you can choose the finish of the canopy
among black, white or any colour
matching one of the pendants.

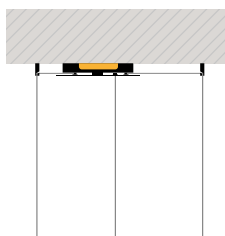
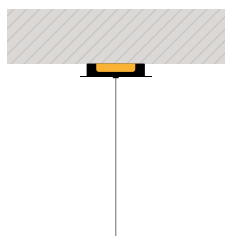

Flat

Design by Ichiro Iwasaki

Flat's distinctive, disc-shaped diffusers form horizontal planes of light that integrate with the surrounding architecture. A study in geometry, the collection creates layers of light that infuse a space with a soothing, Zen sensitivity.

Ceiling

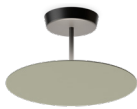

ø 40 cm

5920



ø 55 cm

5915



ø 90 cm

5926



101 x 88 cm

5905

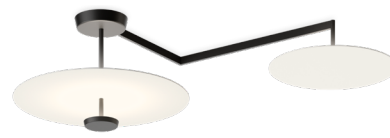

106 x 90 cm

5910

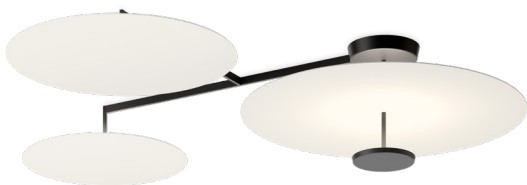

178 x 149 cm

5922



186 x 149 cm

5924

5905

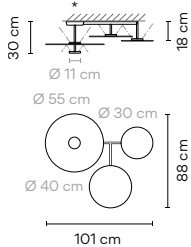

Finishes

- 10/ __ White (NCS S 0300-N)
- 71/ __ White, Green L1, Off-white (NCS S 0300-N, NCS S 4005-G80Y, NCS S 1000-N)

LED temperature colour

- /1 _ 2700 K **E** CRI >90 5906,88 lm 109 lm/W
- /3 _ 3500 K **F** CRI >90 6344,4 lm 117,5 lm/W

Control

5905 __ / __ A
 DALI-2, 1-10V, Push

Materials

Shade: Aluminum. Diffuser: Polycarbonate.
 Structures: Steel. Canopy: Aluminum.

Light Source and electronics

4 x LED PLATE 13,5 W 700 mA
 Constant Current 700 mA
 110-240V 50/60Hz

Packaging

1 Box 0,75 x 0,45 x 0,25 m
 Vol 0,0844 m³
 Gross weight 17,15 Kg Net weight 15,38 Kg

Notes

* Electrical connection point

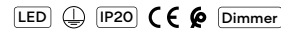

5910

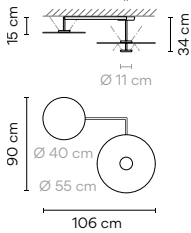

Finishes

- 10/ __ White (NCS S 0300-N)
- 72/ __ White, Green L1 (NCS S 0300-N, NCS S 4005-G80Y)
- 73/ __ White, Grey L1 (S 0300-N, NCS S 1000-N)

LED temperature colour

- /1 _ 2700 K **E** CRI >90 4430,16 lm 109 lm/W
- /3 _ 3500 K **F** CRI >90 4758,3 lm 117,5 lm/W

Control

5910 __ / __ A
 DALI-2, 1-10V, Push

Materials

Shade: Aluminum. Diffuser: Polycarbonate.
 Structures: Steel. Canopy: Aluminum.

Light Source and electronics

3 x LED PLATE 13,5 W 700 mA
 Constant Current 700 mA
 110-240V 50/60Hz

Packaging

1 Box 0,80 x 0,70 x 0,30 m
 Vol 0,1680 m³
 Gross weight 11,90 Kg Net weight 9,10 Kg

Notes

* Electrical connection point



5915

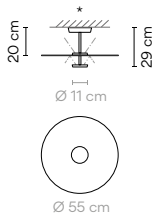

Finishes

- 10/ __ White (NCS S 0300-N)

LED temperature colour

- /1 _ 2700 K **E** CRI >90 2953,44 lm 109 lm/W
- /3 _ 3500 K **F** CRI >90 3172,2 lm 117,5 lm/W

Control

5915 __ / __ A
 DALI-2, 1-10V, Push

Materials

Shade: Aluminum. Diffuser: Polycarbonate.
 Structures: Steel. Canopy: Aluminum.

Light Source and electronics

2 x LED PLATE 13,5 W 700 mA
 Constant Current 700 mA
 110-240V 50/60Hz

Packaging

1 Box 0,65 x 0,65 x 0,25 m
 Vol 0,0106 m³
 Gross weight 6,80 Kg Net weight 4,73 Kg

Notes

* Electrical connection point



5920

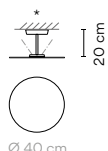

- | | |
|---|-------------------------------|
| Finishes | LED temperature colour |
| ● 10/ __ White
(NCS S 0300-N) | /1 _ 2700 K |
| ● 13/ __ Off-White
(NCS S 1000-N) | CRI >90 1740 lm 129 lm/W |
| ● 47/ __ Green L1
(NCS S 4005-G80Y) | /3 _ 3500 K |
| | CRI >90 1868,9 lm 138,4 lm/W |

- Control**
- 5920** __ / _ 1
DALI-2
-
- 5920** __ / _ B
1-10V, Push

Materials
Shade: Aluminum. Diffuser: Polycarbonate.
Structures: Steel. Canopy: Aluminum.

Light Source and electronics
1 x LED PLATE 13,5 W 700 mA
Constant Current 700 mA
110-240V 50/60Hz

Packaging
1 Box 0,45 x 0,45 x 0,25 m
Vol 0,0051 m³
Gross weight 3,10 Kg Net weight 1,91 Kg

Notes
* Electrical connection point



5922

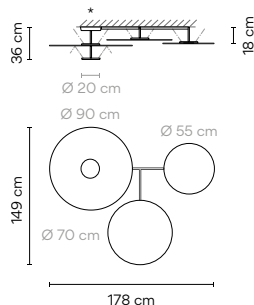

- | | |
|--|-------------------------------|
| Finishes | LED temperature colour |
| ● 10/ __ White
(NCS S 0300-N) | /1 _ 2700 K |
| ● 71/ __ White,
Green L1, Off-white
(NCS S 0300-N,
NCS S 4005-G80Y,
NCS S 1000-N) | CRI >90 13920 lm 139 lm/W |
| | /3 _ 3500 K |
| | CRI >90 14951,1 lm 149,5 lm/W |

- Control**
- 5922** __ / _ A
DALI-2, 1-10V, Push
-
- 5922** __ / _ Z
Casambi

Materials
Shade: Aluminum. Diffuser: Polycarbonate.
Structures: Steel. Canopy: Aluminum.

Light Source and electronics
4 x LED PLATE 25 W 700mA
Constant Current 700 mA
220-240V 50/60Hz

Packaging
1 Box 1,35 x 1,20 x 0,30 m
Vol 0,0486 m³
Gross weight 26,60 Kg Net weight 19,98 Kg

Notes
* Electrical connection point



5924

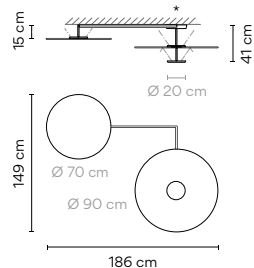

- | | |
|--|-------------------------------|
| Finishes | LED temperature colour |
| ● 10/ __ White
(NCS S 0300-N) | /1 _ 2700 K |
| ● 72/ __ White,
Green L1
(NCS S 0300-N,
NCS S 4005-G80Y) | CRI >90 9897,27 lm 132 lm/W |
| ● 73/ __ White,
Grey L1
(S 0300-N,
NCS S 1000-N) | /3 _ 3500 K |
| | CRI >90 10630,4 lm 141,7 lm/W |

- Control**
- 5924** __ / _ A
DALI-2, 1-10V, Push
-
- 5924** __ / _ Z
Casambi

Materials
Shade: Aluminum. Diffuser: Polycarbonate.
Structures: Steel. Canopy: Aluminum.

Light Source and electronics
3 x LED PLATE 25 W 700mA
Constant Current 700 mA
110-240V 50/60Hz

Packaging
1 Box 1,45 x 1,10 x 0,25 m
Vol 0,0399 m³
Gross weight 27 Kg Net weight 20,80 Kg

Notes
* Electrical connection point



5926

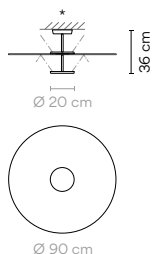

Finishes
 10/ _ _ White
 (NCS S 0300-N)

LED temperature colour
 /1 _ 2700 K **D**
 CRI >90 6598,18 lm 132 lm/W
 /3 _ 3500 K **E**
 CRI >90 7086,9 lm 141,7 lm/W

Control
 5926 _ _ / _ A
 DALI-2, 1-10V, Push

Materials
 Shade: Aluminum. Diffuser: Polycarbonate.
 Structures: Steel. Canopy: Aluminum.

Light Source and electronics
 2 x LED PLATE 25 W 700 mA
 Constant Current 700 mA
 110~240V 50/60Hz

Packaging
 1 Box 1,05 x 1,05 x 0,25 m
 Vol 0,0276 m³
 Gross weight 14,60 Kg Net weight 10,08 Kg

Notes
 * Electrical connection point



Pendants

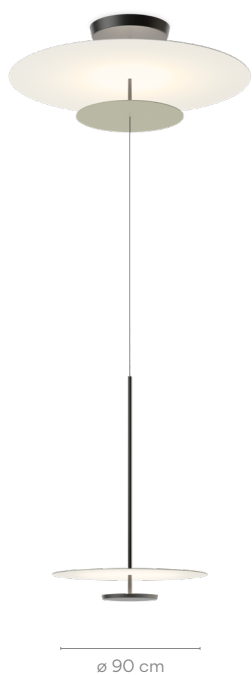

5930



5935



5940

5930

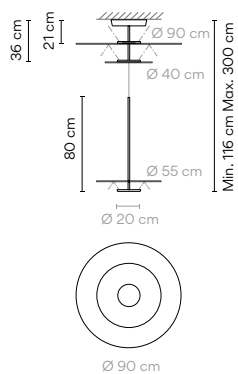

Finishes

- 13/ _ _ Off-White (NCS S 1000-N)
- 37/ _ _ Terra Red (NCS S 4040-Y70R)
- 47/ _ _ Green L1 (NCS S 4005-G80Y)

LED temperature colour

- /1_ 2700 K CRI >90 9897,27 lm 132 lm/W
- /3_ 3500 K CRI >90 10630,4 lm 141,7 lm/W

Control

- 5930 _ _ / _ A
DALI, 1-10V, Push
- 5930 _ _ / _ Z
Casambi

Materials

Shade: Aluminum Diffuser: Polycarbonate.
Structures: Steel. Canopy: Aluminum

Light Source and electronics

3 x LED PLATE 25 W 700mA
Constant Current 700 mA
220-240V 50/60Hz

Packaging

1 Box 0,96x0,96x0,50 m
Vol 0,4608 m³
Gross weight 19 Kg Net weight 10,5 Kg

Notes

Adjust the height on installation



1160 10 /1A _18

Model
Finish
LED temperature colour
Control
Electrical connection
Only for pendants



5935

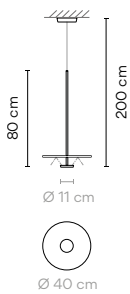

Finishes

- 13/ _ _ Off-White (NCS S 1000-N)
- 37/ _ _ Terra Red (NCS S 4040-Y70R)
- 47/ _ _ Green L1 (NCS S 4005-G80Y)

LED temperature colour

- /1 _ 2700 K CRI >90 1740 lm 129 lm/W
- /3 _ 3500 K CRI >90 1868,9 lm 138,4 lm/W

Control

- 5935 _ _ / _ 1 DALI
- 5935 _ _ / _ B 1-10V, Push

Materials

Shade: Aluminum Diffuser: Polycarbonate.
Structures: Steel. Canopy: Aluminum

Light Source and electronics

1 x LED PLATE 13,5 W 700 mA
Constant Current 700 mA
110-240V 50/60Hz

Packaging

1 Box 0,45 x 0,80 x 0,20 m
Vol 0,0072 m³
Gross weight 6,10 Kg Net weight 5 Kg

Notes

Extra cable length.

Electrical connection

- _18 Surface
- _23 Free Wire
- _23 Built-in
- _31 Remote
- _31 Remote Micro for plaster ceilings
- _32 Remote
- _32 Remote XXS for all types of drop ceilings

5940

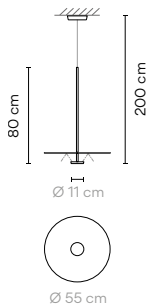

Finishes

- 13/ _ _ Off-White (NCS S 1000-N)
- 37/ _ _ Terra Red (NCS S 4040-Y70R)
- 47/ _ _ Green L1 (NCS S 4005-G80Y)

LED temperature colour

- /1 _ 2700 K CRI >90 1740 lm 129 lm/W
- /3 _ 3500 K CRI >90 1868,9 lm 138,4 lm/W

Control

- 5940 _ _ / _ 1 DALI
- 5940 _ _ / _ B 1-10V, Push

Materials

Shade: Aluminum Diffuser: Polycarbonate.
Structures: Steel. Canopy: Aluminum

Light Source and electronics

1 x LED PLATE 13,5 W 700 mA
Constant Current 700 mA
110-240V 50/60Hz

Packaging

1 Box 0,65 x 0,85 x 0,20 m
Vol 0,0111 m³
Gross weight 7 Kg Net weight 6 Kg

Notes

Extra cable length.

Composing pendants

Next sketches are composed by one or more compositions

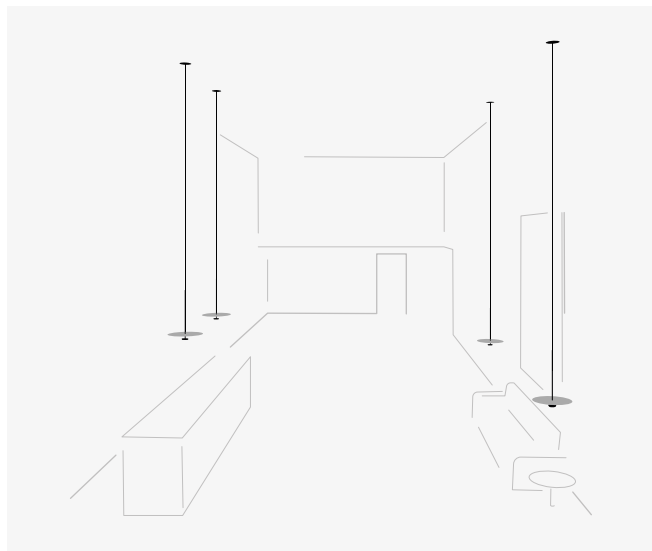

4 x 5935.

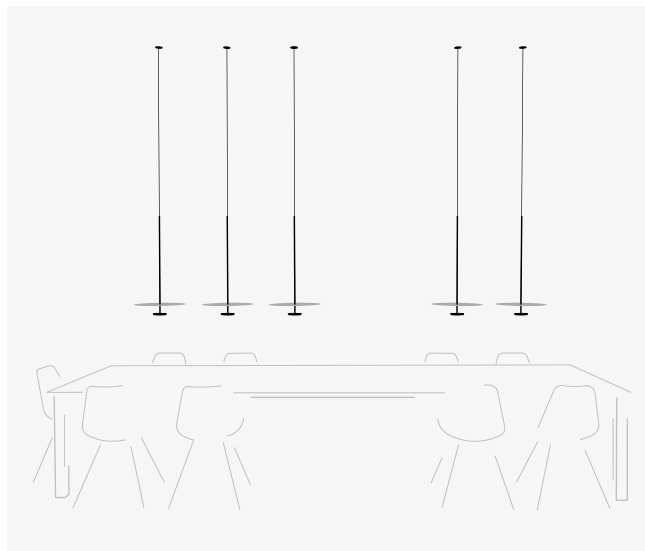

5 x 5935.

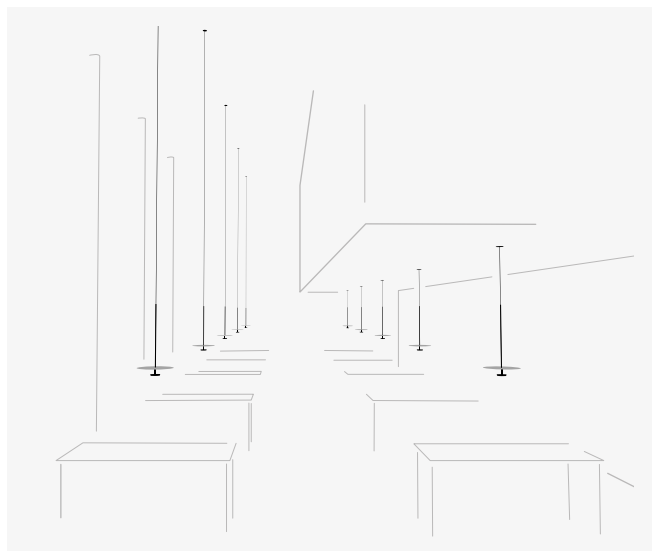

10 x 5935..

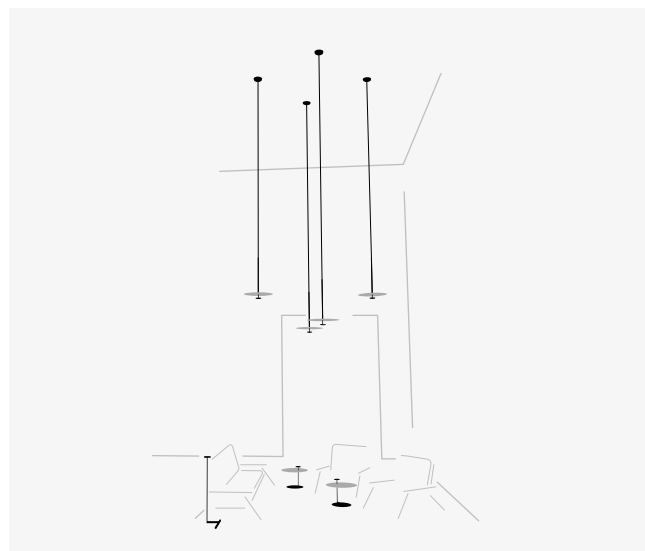

4 x 5935.

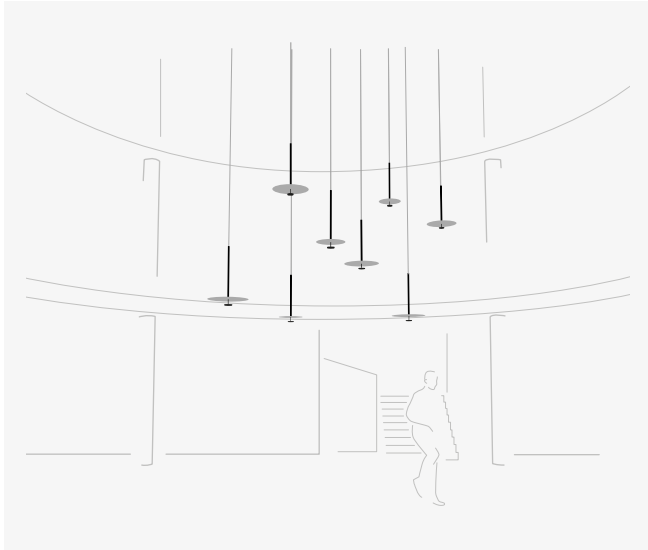

8 x 5935.

Each project is unique.
Visit vibia.com and
choose among multiple
compositions designed
and adapted to your
project needs.

Personalise your own
Flat composition quick
and easy at vibia.com

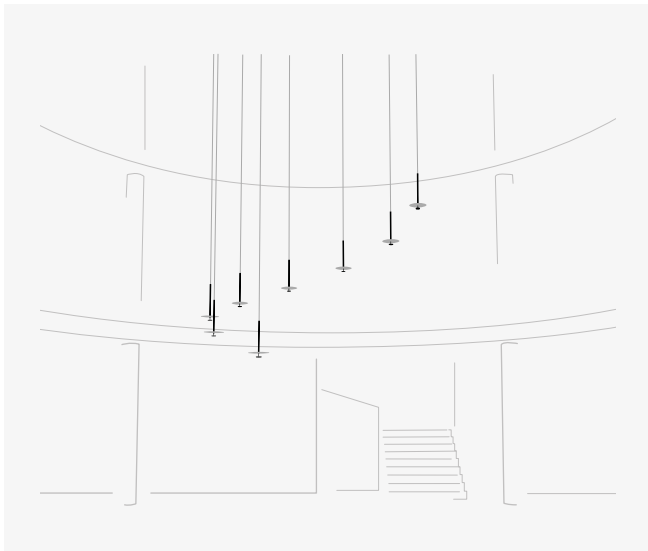

8 x 5935.

Electrical connection options for model 5935

Choose your preferred installation option according to your needs. For each composition, the optimal minimum number of drivers will be delivered.

Drop ceiling

The innovative remote and built-in fittings accentuate the silkiness and lightness of compositions on suspended ceilings, its great visual grandeur taking center stage.

For Ref. 5935

Remote

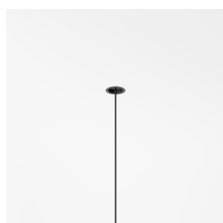

Micro \varnothing 3 cm
height 7 cm
for plaster ceilings.
Black finish.

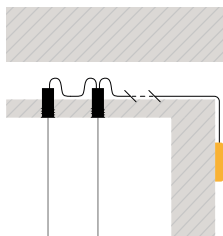

XXS \varnothing 6 cm
height 6 cm
for all types of drop ceilings. Match with fixture finish.

Built-in



\varnothing 8 cm
height 6 cm
match with fixture finish.

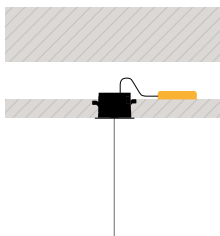

Regular ceiling

When architecture does not allow for performance, surface and free wire showcase possibilities for any need or desire with no limits, ideal for both individual or cluster arrangements.

For Ref. 5935

Surface



ø 16,7 cm
match with
fixture finish.

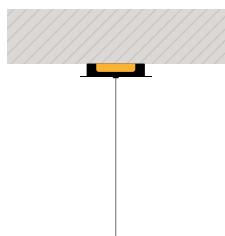

Free Wire

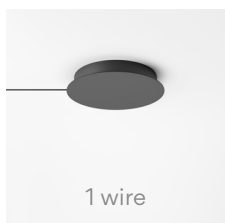

1 wire

ø 20 cm

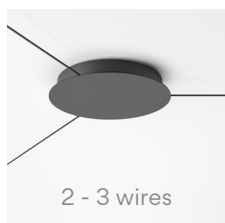

2 - 3 wires

ø 22 cm

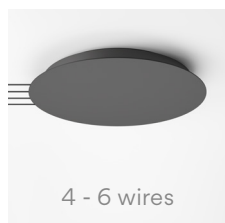

4 - 6 wires

ø 36 cm



7 - 9 wires

ø 40 cm

you can choose the finish of the canopy
among black, white or any colour
matching one of the pendants.

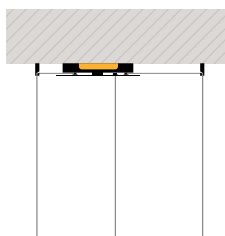

Floor



5945



5950

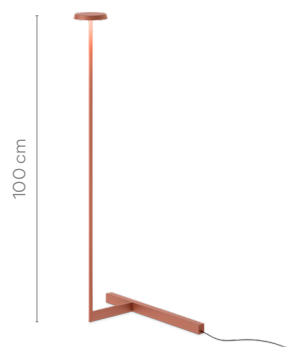

5955



5957

5945

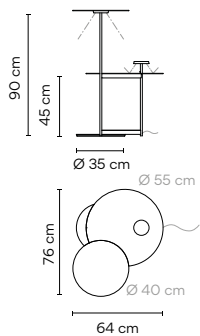

- Finishes**
- 13/ _ _ Off-White (NCS S 1000-N)
 - 47/ _ _ Green L1 (NCS S 4005-G80Y)
- LED temperature colour**
- /1_ 2700 K
 - CRI >90 1365,8 lm 98 lm/W
 - /3_ 3500 K
 - CRI >90 1467,0 lm 104,8 lm/W

Control
5945 _ _ / _ 5
Push

Materials
Shade: Aluminum.
Diffuser: Polycarbonate. Structures: Steel.

Light Source and electronics
2 x LED PLATE 7 W 400 mA
Driver Constant Voltage 24V
110-240V 50/60Hz

Packaging
1 Box 0,65 x 1,00 x 0,25 m
Vol 0,0163 m³
Gross weight 15,85 Kg Net weight 15,25 Kg

Notes
Electric cable 2 m



5950

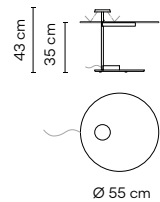

- Finishes**
- 10/ _ _ White (NCS S 0300-N)
- LED temperature colour**
- /1_ 2700 K
 - CRI >90 682,9 lm 98 lm/W
 - /3_ 3500 K
 - CRI >90 733,5 lm 104,8 lm/W

Control
5950 _ _ / _ 5
Push

Materials
Shade: Aluminum.
Diffuser: Polycarbonate. Structures: Steel.

Light Source and electronics
1 x LED PLATE 7 W 400 mA
Driver Constant Voltage 24V
110-240V 50/60Hz

Packaging
1 Box 0,65 x 0,65 x 0,20 m
Vol 0,0085 m³
Gross weight 14,60 Kg Net weight 12,71 Kg

Notes
Electric cable 2 m





5955

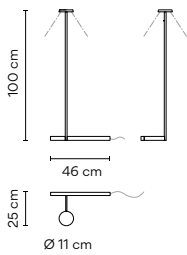

Finishes

- 11/ __ Black (NCS S 8500-N)
- 37/ __ Terra Red (NCS S 4040-Y70R)
- 47/ __ Green L1 (NCS S 4005-G80Y)

LED temperature colour

- /1 _ 2700 K CRI >90 682,9 lm 98 lm/W
- /3 _ 3500 K CRI >90 733,5 lm 104,8 lm/W

Control

5955 __ / _ 5
 Push

Materials

Shade: Aluminum.
 Diffuser: Polycarbonate. Structures: Steel.

Light Source and electronics

1 x LED PLATE 7 W 400 mA
 Driver Constant Voltage 24V
 110-240V 50/60Hz

Packaging

1 Box 0,30 x 1,10 x 0,10 m
 Vol 0,0033 m³
 Gross weight 4,80 Kg Net weight 3,50 Kg

Notes

Electric cable 2 m

5957

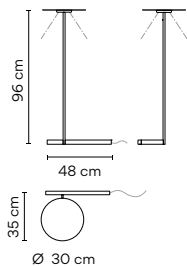

Finishes

- 37/ __ Terra Red (NCS S 4040-Y70R)
- 47/ __ Green L1 (NCS S 4005-G80Y)

LED temperature colour

- /1 _ 2700 K CRI >90 682,9 lm 98 lm/W
- /3 _ 3500 K CRI >90 733,5 lm 104,8 lm/W

Control

5957 __ / _ 5
 Push

Materials

Shade: Aluminum.
 Diffuser: Polycarbonate. Structures: Steel.

Light Source and electronics

1 x LED PLATE 7 W 400 mA
 Constant Voltage 24V
 110-240V 50/60Hz

Packaging

1 Box 0,40 x 1,10 x 0,10 m
 Vol 0,0044 m³
 Gross weight 6,10 Kg Net weight 4,46 Kg

Notes

Electric cable 2 m

Table



5965

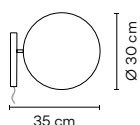

- Finishes**
- 13/ _ _ Off-White (NCS S 1000-N)
 - 47/ _ _ Green L1 (NCS S 4005-G80Y)

LED temperature colour
/1_ 2700 K **F**
CRI >90 682,9 lm 98 lm/W

Control
5965 _ _ / _ 5
Push

Materials
Shade: Aluminum.
Diffuser: Polycarbonate. Structures: Steel.

Light Source and electronics
1 x LED PLATE 7W 400mA
Constant Voltage 24V
110-240V 50/60Hz

Packaging
1 Box 0,50 x 0,50 x 0,7 m
Vol 0,0018 m³
Gross weight 4 Kg Net weight 3,11 Kg

Notes
Electric cable 2 m

LED IP20 Dimmer

5970

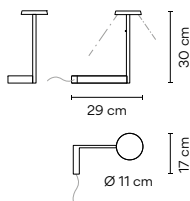

- Finishes**
- 11/ _ _ Black (NCS S 8500-N)
 - 37/ _ _ Terra Red (NCS S 4040-Y70R)
 - 47/ _ _ Green L1 (NCS S 4005-G80Y)

LED temperature colour
/1_ 2700 K **F**
CRI >90 682,9 lm 98 lm/W

Control
5970 _ _ / _ 5
Push

Materials
Shade: Aluminum.
Diffuser: Polycarbonate. Structures: Steel.

Light Source and electronics
1 x LED PLATE 7W 400mA
Constant Voltage 24V
110-240V 50/60Hz

Packaging
1 Box 0,20 x 0,40 x 0,07 m
Vol 0,0072 m³
Gross weight 4 Kg Net weight 3,11 Kg

Notes
Electric cable 2 m

LED IP20 Dimmer



Spa

Design by Ramos & Bassols

Spa is the perfect lighting solution for any wellness space. From public dressing rooms, restaurants and spas, to private kitchens, corridors and bathrooms, its graceful simplicity allows for easy cleaning and seamless integration within the surrounding architecture of a variety of interiors.

Ceiling Wall



5975



5977



5979



5981

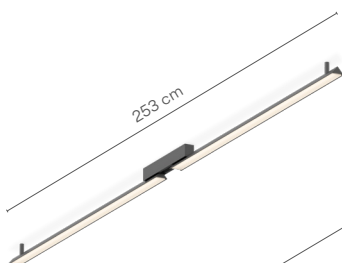

5983



5985

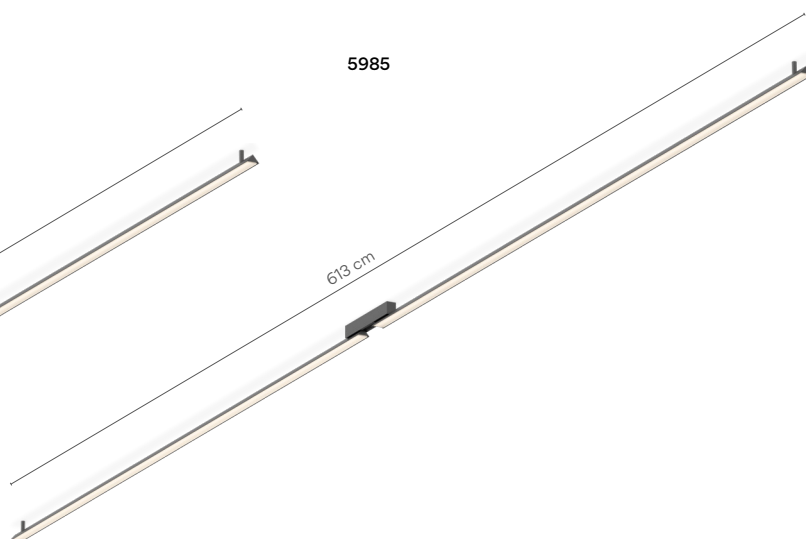



5975

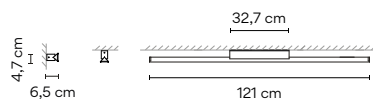

Finishes

- 11/ __ Black (NCS S 8500-N)
- 23/ __ Warm White (NCS S 0502-Y50R)
- 25/ __ Beige D1 (NCS S 4005-Y50R)

LED temperature colour

- /1_ 2700 K CRI >90 1560 lm 144 lm/W
- /3_ 3500 K CRI >90 1290 lm 178 lm/W

Control

- 5975 __ / _ 1 DALI
- 5975 __ / _ 3 1-10V
- 5975 __ / _ Z_ 30 Casambi (Remote)

Materials

Profile: Aluminum. Difuser: PMMA & Silicone.
 Canopy: Aluminum.

Light Source and electronics

1 x LED STRIP 10,8 W 600 mA
 Constant Current 600 mA
 220~240V 50/60Hz

Packaging

1 Box 1,5 x 0,1 x 0,1 m
 Vol 0,015 m³
 Gross weight 3,1 Kg Net weight 1,6 Kg



5977

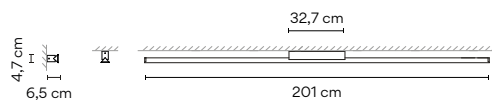

Finishes

- 11/ __ Black (NCS S 8500-N)
- 23/ __ Warm White (NCS S 0502-Y50R)
- 25/ __ Beige D1 (NCS S 4005-Y50R)

LED temperature colour

- /1_ 2700 K CRI >90 2560 lm 119 lm/W
- /3_ 3500 K CRI >90 3360 lm 156 lm/W

Control

- 5977 __ / _ 1 DALI
- 5977 __ / _ 3 1-10V
- 5977 __ / _ Z_ 30 Casambi (Remote)

Materials

Profile: Aluminum. Difuser: PMMA & Silicone.
 Canopy: Aluminum.

Light Source and electronics

1 x LED STRIP 21,6 W 600 mA
 Constant Current 600 mA
 220~240V 50/60Hz

Packaging

1 Box 2,3 x 0,1 x 0,1 m
 Vol 0,023 m³
 Gross weight 4,9 Kg Net weight 2,6



5979

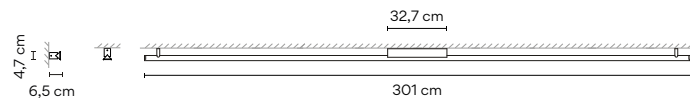

- Finishes**
- **11/** __ Black
(NCS S 8500-N)
 - **23/** __ Warm White
(NCS S 0502-Y50R)
 - **25/** __ Beige D1
(NCS S 4005-Y50R)

LED temperature colour	
/1 _	2700 K
	CRI >90 3840 lm 119 lm/W
/3 _	3500 K
	CRI >90 5040 lm 156 lm/W

Control

5979 __ / _ 1
DALI

5979 __ / _ 3
1-10V

5979 __ / _ Z 30
Casambi (Remote)

Materials

Profile: Aluminum. Difuser: PMMA & Silicone.
Canopy: Aluminum.

Light Source and electronics

1 x LED STRIP 32,4 W 600 mA
Constant Current 600 mA
220~240V 50/60Hz

Packaging

1 Box 3,3 x 0,1 x 0,1 m
Vol 0,033 m³
Gross weight 6,9 Kg Net weight 3,6 Kg



5981

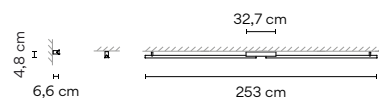

- Finishes**
- **11/** __ Black
(NCS S 8500-N)
 - **23/** __ Warm White
(NCS S 0502-Y50R)
 - **25/** __ Beige D1
(NCS S 4005-Y50R)

LED temperature colour	
/1 _	2700 K
	CRI >90 3120 lm 144 lm/W
/3 _	3500 K
	CRI >90 3840 lm 178 lm/W

Control

5981 __ / _ 1
DALI

5981 __ / _ 3
1-10V

5981 __ / _ Z 30
Casambi (Remote)

Materials

Profile: Aluminum. Difuser: PMMA & Silicone.
Canopy: Aluminum.

Light Source and electronics

2 x LED STRIP 10,8 W 600 mA
Constant Current 600 mA
220~240V 50/60Hz

Packaging

2 Boxes
Total Vol 0,030 m³
Gross weight 5,8 Kg Net weight 2,8 Kg



5983

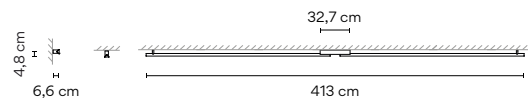

- Finishes**
- **11/** __ Black
(NCS S 8500-N)
 - **23/** __ Warm White
(NCS S 0502-Y50R)
 - **25/** __ Beige D1
(NCS S 4005-Y50R)

LED temperature colour	
/1 _	2700 K
	CRI >90 5120 lm 119 lm/W
/3 _	3500 K
	CRI >90 6720 lm 156 lm/W

Control

5983 __ / _ 1
DALI

5983 __ / _ 3
1-10V

5983 __ / _ Z 30
Casambi (Remote)

Materials

Profile: Aluminum. Difuser: PMMA & Silicone.
Canopy: Aluminum.

Light Source and electronics

2 x LED STRIP 21,6 W 600 mA
Constant Current 1200 mA
220~240V 50/60Hz

Packaging

2 Boxes
Total Vol 0,046 m³
Gross weight 9,4 Kg Net weight 4,8 Kg



5985

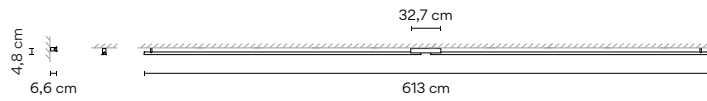

Finishes	LED temperature colour	Control
● 11/ _ _ Black (NCS S 8500-N)	/1 _ 2700 K CRI >90 7680 lm 119 lm/W	5985 _ _ / _ 1 DALI (Remote)
● 23/ _ _ Warm White (NCS S 0502-Y50R)	/3 _ 3500 K CRI >90 10080 lm 156 lm/W	5985 _ _ / _ 3 1-10V (Remote)
● 25/ _ _ Beige D1 (NCS S 4005-Y50R)		5985 _ _ / _ Z Casambi (Remote)

Materials

Profile: Aluminum. Difuser: PMMA & Silicone.
 Canopy: Aluminum.

Light Source and electronics

2 x LED STRIP 32,4 W 600 mA
 Constant Current 600 mA Remote
 220-240V 50/60Hz

Packaging

2 Boxes
 Total Vol 0,066 m³
 Gross weight 13,5 Kg Net weight 6,9 Kg



Wall Vanity light

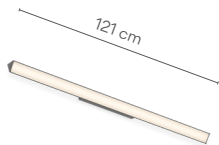

5987

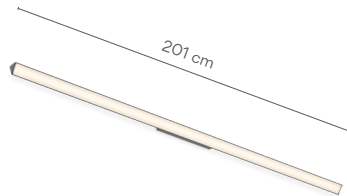

5989

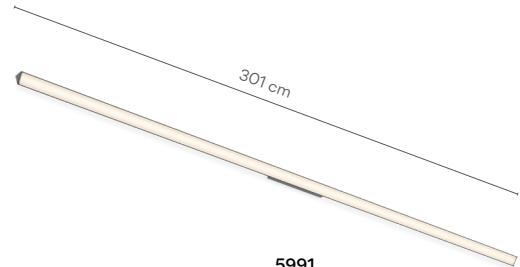

5991



5987

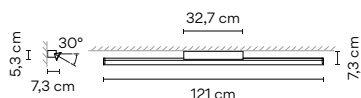

Finishes	LED temperature colour
● 11/ __ Black (NCS S 8500-N)	/1 _ 2700 K CRI >90 1560 lm 144 lm/W
● 23/ __ Warm White (NCS S 0502-Y50R)	/3 _ 3500 K CRI >90 1920 lm 178 lm/W
● 25/ __ Beige D1 (NCS S 4005-Y50R)	

Control

5987 __ / _ 1
DALI

5985 __ / _ 3
1-10V

5985 __ / _ Z
Casambi (Remote)

Materials

Profile: Aluminum. Difuser: PMMA & Silicone.
Canopy: Aluminum.

Light Source and electronics

1 x LED STRIP 10,8 W 600 mA
Constant Current 600 mA
220-240V 50/60Hz

Packaging

1 Box 1,5 x 0,1 x 0,1 m
Vol 0,015 m³
Gross weight 3,1 Kg Net weight 1,6 Kg

Notes

Central canopy with module
LED inclined 30°

5989

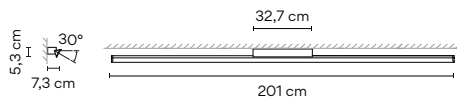

Finishes	LED temperature colour
● 11/ __ Black (NCS S 8500-N)	/1 _ 2700 K CRI >90 2560 lm 119 lm/W
● 23/ __ Warm White (NCS S 0502-Y50R)	/3 _ 3500 K CRI >90 3360 lm 156 lm/W
● 25/ __ Beige D1 (NCS S 4005-Y50R)	

Control

5989 __ / _ 1
DALI

5989 __ / _ 3
1-10V

5989 __ / _ Z
Casambi (Remote)

Materials

Profile: Aluminum. Difuser: PMMA & Silicone.
Canopy: Aluminum.

Light Source and electronics

1 x LED STRIP 21,6 W 600 mA
Constant Current 600 mA
220-240V 50/60Hz

Packaging

1 Box 2,3 x 0,1 x 0,1 m
Vol 0,023 m³
Gross weight 4,9 Kg Net weight 2,6 Kg

Notes

Central canopy with module
LED inclined 30°

5991

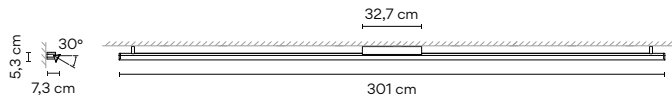

Finishes	LED temperature colour
● 11/ __ Black (NCS S 8500-N)	/1 _ 2700 K CRI >90 3840 lm 119 lm/W
● 23/ __ Warm White (NCS S 0502-Y50R)	/3 _ 3500 K CRI >90 5040 lm 156 lm/W
● 25/ __ Beige D1 (NCS S 4005-Y50R)	

Control

5991 __ / _ 1
DALI

5991 __ / _ 3
1-10V

5991 __ / _ Z
Casambi (Remote)

Materials

Profile: Aluminum. Difuser: PMMA & Silicone.
Canopy: Aluminum.

Light Source and electronics

1 x LED STRIP 32,4 W 600 mA
Constant Current 600 mA
220-240V 50/60Hz

Packaging

1 Box 3,3 x 0,1 x 0,1 m
Vol 0,033 m³
Gross weight 6,9 Kg Net weight 3,6 Kg

Notes

Central canopy with module
LED inclined 30°

Vertical Wall

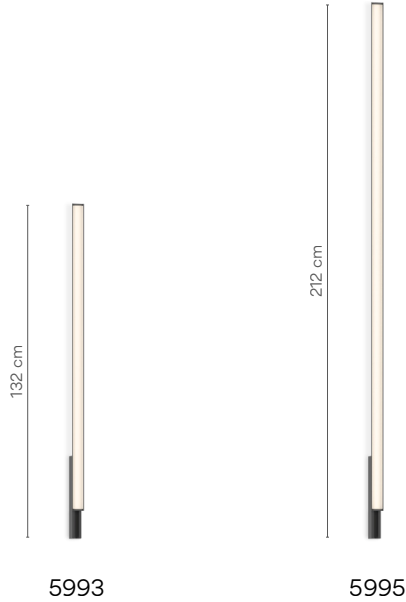

5993

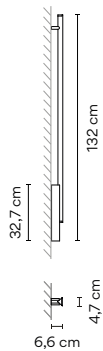

Finishes

- 11/ __ Black (NCS S 8500-N)
- 23/ __ Warm White (NCS S 0502-Y50R)
- 25/ __ Beige D1 (NCS S 4005-Y50R)

LED temperature colour

- /1 _ 2700 K CRI >90 1560 lm 144 lm/W
- /3 _ 3500 K CRI >90 1920 lm 178 lm/W

Control

- 5993 __ / _ 1 DALI
- 5993 __ / _ 3 1-10V
- 5993 __ / _ Z Casambi (Remote)

Materials

Profile: Aluminum. Difuser: PMMA & Silicone.
 Canopy: Aluminum.

Light Source and electronics

1 x LED STRIP 10,8W 600 mA
 Constant Current 600 mA
 220-240V 50/60Hz

Packaging

1 Box 1,5 x 0,1 x 0,1 m
 Vol 0,015 m³
 Gross weight 3,1 Kg Net weight 1,6 Kg



5995

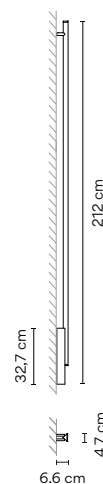

Finishes

- 11/ __ Black (NCS S 8500-N)
- 23/ __ Warm White (NCS S 0502-Y50R)
- 25/ __ Beige D1 (NCS S 4005-Y50R)

LED temperature colour

- /1 _ 2700 K CRI >90 2560 lm 119 lm/W
- /3 _ 3500 K CRI >90 3360 lm 156 lm/W

Control

- 5995 __ / _ 1 DALI
- 5995 __ / _ 3 1-10V
- 5995 __ / _ Z Casambi (Remote)

Materials

Profile: Aluminum. Difuser: PMMA & Silicone.
 Canopy: Aluminum.

Light Source and electronics

1 x LED STRIP 21,6 W 600 mA
 Constant Current 600 mA
 220-240V 50/60Hz

Packaging

1 Box 2,3 x 0,1 x 0,1 m
 Vol 0,023 m³
 Gross weight 4,9 Kg Net weight 2,6 Kg



Suite

Design by Jordi Vilardell & Meritxell Vidal

Reinterprets and updates the traditional combination of side table or shelf with table lamp. Its warm and comfortable lighting effect appears when least expected, a pleasant luminous surprise.

Floor Table

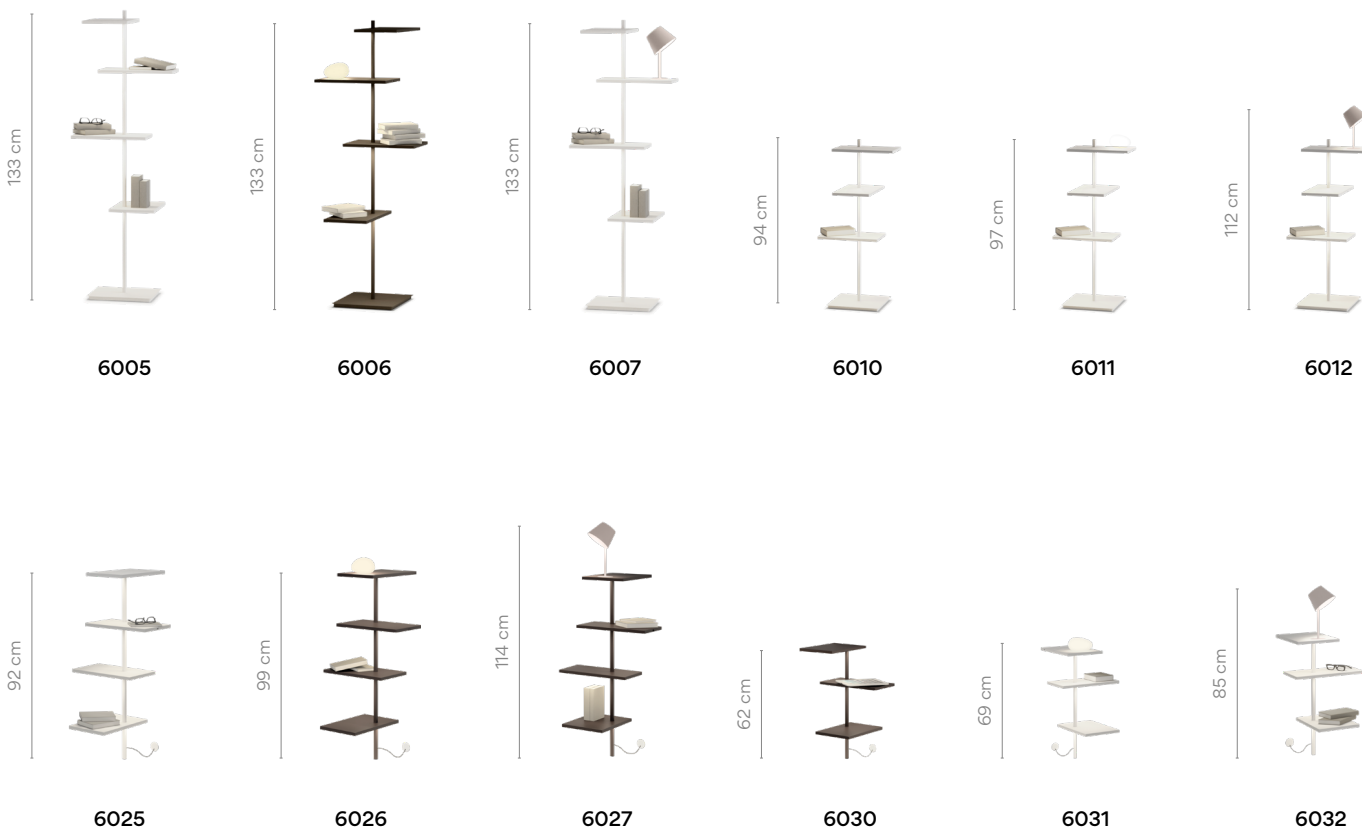

6005

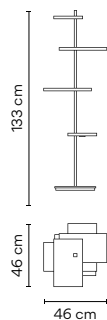

- Finishes**
- 14/ __ Chocolate (RAL 8019)
 - 93/ __ White (RAL 9016)

Finish customization
(Available options:
Vibia colour palette)

Materials
Shelf: Aluminum. Diffuser: Polycarbonate.
Vertical tube: Steel. Base: Steel. Lid: ABS with fiberglass.

Light Source and electronics
8 x LED STRIP 24V 1,63 W
Constant Voltage 24V
220~240V 50Hz

LED temperature colour
/1_ 2700 K 
CRI >90 1054,6 lm 78 lm/W

Control
6005 __ / __ 0
On/ Off

Packaging
1 Box 0,730 x 0,535 x 1,385 m
Vol 0,4513 m³
Gross weight 34,1 Kg Net weight 16,5 Kg

Notes
USB charging connection.
LED on/off switch under the shelf.
Electric cable 2,5 m.

UNTIL STOCK RUNS OUT

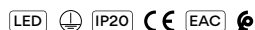

6006

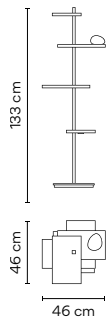

<p>Finishes</p> <ul style="list-style-type: none"> ● 14/ __ Chocolate (RAL 8019) ● 93/ __ White (RAL 9016) <p>Finish customization (Available options: Vibia colour palette)</p> <hr/> <p>Materials Shelf: Aluminum. Diffuser: Polycarbonate. Vertical tube: Steel. Base: Steel. Lid: ABS with fiberglass.</p> <p>Light Source and electronics 8 x LED STRIP 24V 1,63 W. 1 x LED 4,5 W 350 mA Constant Current / Constant Voltage 350 24V 220-240V 50Hz</p>	<p>LED temperature colour /1_ 2700 K CRI >90 1539,64 lm 88 lm/W</p>	<p>Control 6006 __ / _ 5 Push</p> <hr/> <p>Packaging 1 Box 0,730 x 0,535 x 1,385 m Vol 0,4513 m³ Gross weight 34,3 Kg Net weight 16,7 Kg</p> <p>Notes Glass diffuser mounted on shelf with dimmable light. USB charging connection. LED on/off switch under the shelf. Electric cable 2,5 m.</p> <p style="text-align: right;"> </p>
---	---	--

6007

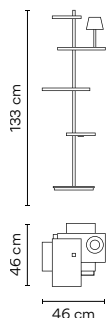

<p>Finishes</p> <ul style="list-style-type: none"> ● 14/ __ Chocolate (RAL 8019) ● 93/ __ White (RAL 9016) <p>Finish customization (Available options: Vibia colour palette)</p> <hr/> <p>Materials Shelf: Aluminum. Diffuser: Polycarbonate. Vertical tube: Steel. Base: Steel. Lid: ABS with fiberglass.</p> <p>Light Source and electronics 8 x LED STRIP 24V 1,63 W. 1 x LED 4,5 W 350 mA Constant Current / Constant Voltage 350 24V 220-240V 50Hz</p>	<p>LED temperature colour /1_ 2700 K CRI >90 1539,64 lm 88 lm/W</p>	<p>Control 6007 __ / _ 5 Push</p> <hr/> <p>Packaging 1 Box 0,730 x 0,535 x 1,385 m Vol 0,4513 m³ Gross weight 34,3 Kg Net weight 17 Kg</p> <p>Notes Reading light mink (Pantone 407C), mounted on shelf with dimmable light. USB charging connection. LED on/off switch under the shelf. Electric cable 2,5 m.</p> <p style="text-align: right;"> </p>
---	---	--

6010

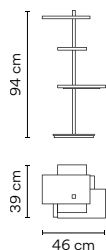

<p>Finishes</p> <ul style="list-style-type: none"> ● 14/ __ Chocolate (RAL 8019) ● 93/ __ White (RAL 9016) <p>Finish customization (Available options: Vibia colour palette)</p> <hr/> <p>Materials Shelf: Aluminum. Diffuser: Polycarbonate. Vertical tube: Steel. Base: Steel. Lid: ABS with fiberglass.</p> <p>Light Source and electronics 6 x LED STRIP 24V 1,63 W Constant Voltage 24V 220-240V 50Hz</p>	<p>LED temperature colour /1_ 2700 K CRI >90 791 lm 77 lm/W</p>	<p>Control 6010 __ / _ 0 On/ Off</p> <hr/> <p>Packaging 1 Box 0,45 x 0,80 x 0,20 m Vol 0,0072 m³ Gross weight 16,10 Kg Net weight 16,10 Kg</p> <p>Notes USB charging connection. LED on/off switch under the shelf. Electric cable 2,5 m.</p> <p>UNTIL STOCK RUNS OUT</p> <p style="text-align: right;"> </p>
---	---	---

6011

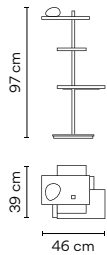

Finishes
 ● 14/ _ _ Chocolate (RAL 8019)
 ● 93/ _ _ White (RAL 9016)

LED temperature colour
 /1_ 2700 K 
 CRI >90 790,98 lm 55 lm/W

Control
 6011 _ _ / _ 5
 Push

Finish customization
 (Available options:
 Vibia colour palette)

Materials
 Shelf: Aluminum. Diffuser: Polycarbonate.
 Vertical tube: Steel. Base: Steel. Lid: ABS with fiberglass.

Packaging
 1 Box 0,730 x 0,535 x 1,385 m
 Vol 0,3623 m³
 Gross weight 32,4 Kg Net weight 15,7 Kg

Light Source and electronics
 6 x LED STRIP 24V 1,63 W.
 1 x LED 4,5 W 350 mA
 Constant Current / Constant Voltage 350 24V
 220-240V 50Hz

Notes
 Glass diffuser mounted on shelf
 with dimmable light.
 USB charging connection.
 LED on/off switch under the shelf.
 Electric cable 2,5 m

6012

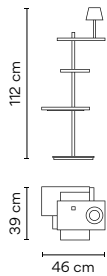

Finishes
 ● 14/ _ _ Chocolate (RAL 8019)
 ● 93/ _ _ White (RAL 9016)

LED temperature colour
 /1_ 2700 K 
 CRI >90 1275,98 lm 89 lm/W

Control
 6012 _ _ / _ 5
 Push

Finish customization
 (Available options:
 Vibia colour palette)

Materials
 Shelf: Aluminum. Diffuser: Polycarbonate.
 Vertical tube: Steel. Base: Steel. Lid: ABS with fiberglass.

Packaging
 1 Box 0,730 x 0,535 x 1,385 m
 Vol 0,3623 m³
 Gross weight 33,6 Kg Net weight 16 Kg

Light Source and electronics
 6 x LED STRIP 24V 1,63 W.
 1 x LED 4,5 W 350 mA
 Constant Current / Constant Voltage 350 24V
 220-240V 50Hz

Notes
 Reading light mink (Pantone 407C),
 mounted on shelf with dimmable light.
 USB charging connection.
 LED on/off switch under the shelf.
 Electric cable 2,5 m

6025

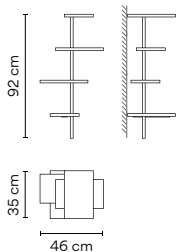

Finishes
 ● 14/ _ _ Chocolate (RAL 8019)
 ● 93/ _ _ White (RAL 9016)

LED temperature colour
 /1_ 2700 K 
 CRI >90 1054,6 lm 78 lm/W

Control
 6025 _ _ / _ 0
 On/ Off

Finish customization
 (Available options:
 Vibia colour palette)





Materials
 Shelf: Aluminum. Diffuser: Polycarbonate.
 Vertical tube: Steel. Lid: ABS with fiberglass.

Packaging
 1 Box 0,61 x 0,54 x 1,1 m
 Vol 0,3623 m³
 Gross weight 11 Kg Net weight 5,6 Kg

Light Source and electronics
 8 x LED STRIP 24V 1,63W
 Constant Voltage 24V
 220-240V 50Hz

Notes
 USB charging connection.
 LED on/off switch under the shelf.
 Electric cable 2,5 m.

UNTIL STOCK RUNS OUT

6026

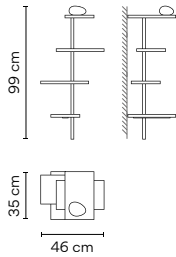

Finishes
 ● 14/ __ Chocolate (RAL 8019)
 ● 93/ __ White (RAL 9016)

LED temperature colour
 /1_ 2700 K [F] CRI >90 1539,6 lm 88 lm/W

Control
 6026 __ / _ 5
 Push

Finish customization
 (Available options:
 Vibia colour palette)

Materials
 Shelf: Aluminum. Diffuser: Polycarbonate.
 Vertical tube: Steel. Lid: ABS with fiberglass.

Light Source and electronics
 8 x LED STRIP 24V 1,63 W.
 1 x LED 4,5 W 350 mA
 Constant Current / Constant Voltage 350 24V
 220-240V 50Hz

Packaging
 1 Box 0,61 x 0,54 x 1,1 m
 Vol 0,3623 m³
 Gross weight 11,2 Kg Net weight 5,8 Kg

Notes
 Glass diffuser mounted on shelf with dimmable light.
 USB charging connection.
 LED on/off switch under the shelf.
 Electric cable 2,5 m.

UNTIL STOCK RUNS OUT



6027

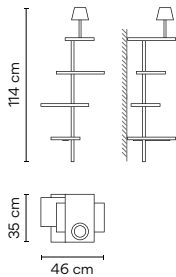

Finishes
 ● 14/ __ Chocolate (RAL 8019)
 ● 93/ __ White (RAL 9016)

LED temperature colour
 /1_ 2700 K [F] CRI >90 1539,6 lm 88 lm/W

Control
 6027 __ / _ 5
 Push

Finish customization
 (Available options:
 Vibia colour palette)

Materials
 Shelf: Aluminum. Diffuser: Polycarbonate.
 Vertical tube: Steel. Lid: ABS with fiberglass.

Light Source and electronics
 8 x LED STRIP 24V 1,63 W.
 1 x LED 4,5 W 350 mA
 Constant Current / Constant Voltage 350 24V
 220-240V 50Hz

Packaging
 1 Box 0,61 x 0,54 x 1,1 m
 Vol 0,4513 m³
 Gross weight 12,4 Kg Net weight 6,1 Kg

Notes
 Reading light mink (Pantone 407C), mounted on shelf with dimmable light.
 USB charging connection.
 LED on/off switch under the shelf.
 Electric cable 2,5 m.

UNTIL STOCK RUNS OUT



6030

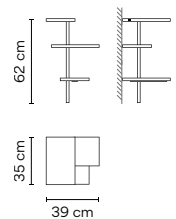

Finishes
 ● 14/ __ Chocolate (RAL 8019)
 ● 93/ __ White (RAL 9016)

LED temperature colour
 /1_ 2700 K [F] CRI >90 791,0 lm 77 lm/W

Control
 6030 __ / _ 0
 On/ Off

Finish customization
 (Available options:
 Vibia colour palette)

Materials
 Shelf: Aluminum. Diffuser: Polycarbonate.
 Vertical tube: Steel. Lid: ABS with fiberglass.

Light Source and electronics
 6 x LED STRIP 24V 1,63 W
 Constant Voltage 24V
 220-240V 50Hz

Packaging
 1 Box 0,61 x 0,54 x 1,1 m
 Vol 0,3623 m³
 Gross weight 9,8 Kg Net weight 4,4 Kg

Notes
 USB charging connection.
 LED on/off switch under the shelf.
 Electric cable 2,5 m.

UNTIL STOCK RUNS OUT

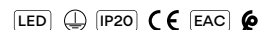

6031

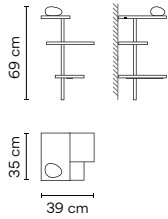

Finishes
 ● 14/ _ _ Chocolate (RAL 8019)
 ● 93/ _ _ White (RAL 9016)

LED temperature colour
 /1_ 2700 K 
 CRI >90 791,0 lm 55 lm/W

Control
 6031 _ _ / _ 5
 Push

Finish customization
 (Available options:
 Vibia colour palette)

Materials
 Shelf: Aluminum. Diffuser: Polycarbonate.
 Vertical tube: Steel. Lid: ABS with fiberglass

Light Source and electronics
 6 x LED STRIP 24V 1,63 W.
 1 x LED 4,5 W 350 mA
 Constant Current / Constant Voltage 350 24V
 220-240V 50Hz

Packaging
 1 Box 0,61 x 0,54 x 1,1 m
 Vol 0,3623 m³
 Gross weight 10 Kg Net weight 4,6 Kg

Notes
 Glass diffuser mounted on shelf
 with dimmable light.
 USB charging connection.
 LED on/off switch under the shelf.
 Electric cable 2,5 m.

UNTIL STOCK RUNS OUT

6032

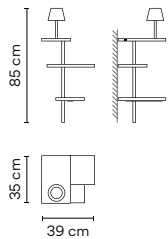

Finishes
 ● 14/ _ _ Chocolate (RAL 8019)
 ● 93/ _ _ White (RAL 9016)

LED temperature colour
 /1_ 2700 K 
 CRI >90 791,0 lm 55 lm/W

Control
 6032 _ _ / _ 5
 Push

Finish customization
 (Available options:
 Vibia colour palette)

Materials
 Shelf: Aluminum. Diffuser: Polycarbonate.
 Vertical tube: Steel. Lid: ABS with fiberglass.

Light Source and electronics
 6 x LED STRIP 24V 1,63 W.
 1 x LED 4,5 W 350 mA
 Constant Current / Constant Voltage 350 24V
 220-240V 50Hz

Packaging
 1 Box 0,61 x 0,54 x 1,1 m
 Vol 0,3623 m³
 Gross weight 10,3 Kg Net weight 4,9 Kg

Notes
 Reading light mink (Pantone 407C),
 mounted on shelf with dimmable light.
 USB charging connection.
 LED on/off switch under the shelf.
 Electric cable 2,5 m.

UNTIL STOCK RUNS OUT

    

Wall



<p>6035</p>	<p>Finishes</p> <ul style="list-style-type: none"> ● 14/ _ _ Chocolate (RAL 8019) ● 93/ _ _ White (RAL 9016) <p>Finish customization (Available options: Vibia colour palette)</p> <hr/> <p>Materials Shelf: Aluminum. Diffuser: Polycarbonate. Lid: Steel.</p> <p>Light Source and electronics 1 x LED STRIP 24V 1,63 W Constant Voltage 24V 220-240V 50Hz</p>	<p>LED temperature colour /1_ 2700 K CRI >90 131,8 lm 81 lm/W</p> <p>Control 6035 _ / _ 0 On/ Off</p> <hr/> <p>Packaging 1 Box 0,21 x 0,48 x 0,21 m Vol 0,0212 m³ Gross weight 1,8 Kg Net weight 1,5 Kg</p> <p>Notes UNTIL STOCK RUNS OUT</p> <p> </p>
<p>6040</p>	<p>Finishes</p> <ul style="list-style-type: none"> ● 14/ _ _ Chocolate (RAL 8019) ● 93/ _ _ White (RAL 9016) <p>Finish customization (Available options: Vibia colour palette)</p> <hr/> <p>Materials Shelf: Aluminum. Diffuser: Blown-glass. Lid: Steel.</p> <p>Light Source and electronics 1 x LED 4,5 W 350 mA Constant Current 350 mA 220-240V 50Hz</p>	<p>LED temperature colour /1_ 2700 K CRI >90 485 lm 121 lm/W</p> <p>Control 6040 _ / _ 0 On/ Off</p> <hr/> <p>Packaging 1 Box 0,21 x 0,48 x 0,21 m Vol 0,0212 m³ Gross weight 2,6 Kg Net weight 1,6 Kg</p> <p> </p>
<p>6041</p>	<p>Finishes</p> <ul style="list-style-type: none"> ● 14/ _ _ Chocolate (RAL 8019) ● 93/ _ _ White (RAL 9016) <p>Finish customization (Available options: Vibia colour palette)</p> <hr/> <p>Materials Shelf: Aluminum. Diffuser: Blown-glass. Lid: Steel.</p> <p>Light Source and electronics 1 x LED 4,5 W 350 mA Constant Current 350 mA 220-240V 50/60Hz</p>	<p>LED temperature colour /1_ 2700 K CRI >90 485 lm 121 lm/W</p> <p>Control 6041 _ / _ 0 On/ Off</p> <hr/> <p>Packaging 1 Box 0,21 x 0,48 x 0,21 m Vol 0,0212 m³ Gross weight 2,6 Kg Net weight 1,6 Kg</p> <p> </p>

6045

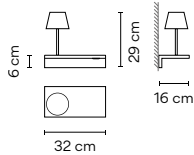

- Finishes
- 14/ __ Chocolate (RAL 8019)
 - 93/ __ White (RAL 9016)

Finish customization
 (Available options:
 Vibia colour palette)

Materials

Shelf: Aluminum. Diffuser: Polycarbonate.
 Lid: Steel.

Light Source and electronics

1 x LED STRIP 24V 1,63W.
 1 x LED 4,5W 350mA.
 Constant Current / Constant Voltage 350 24V
 220~240V 50Hz

LED temperature colour
 /1_ 2700 K
 CRI >90 616,83 lm 101 lm/W

Control
 6045 __ / __ 0
 On/ Off

Packaging

1 Box 0,29 x 0,38 x 0,38 m
 Vol 0,418 m³
 Gross weight 2,6 Kg Net weight 1,8 Kg

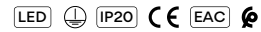

6046

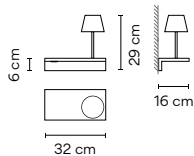

- Finishes
- 14/ __ Chocolate (RAL 8019)
 - 93/ __ White (RAL 9016)

Finish customization
 (Available options:
 Vibia colour palette)

Materials

Shelf: Aluminum. Diffuser: Polycarbonate.
 Lid: Steel.

Light Source and electronics

1 x LED STRIP 24V 1,63W.
 1 x LED 4,5W 350mA.
 Constant Current / Constant Voltage 350 24V
 220~240V 50Hz

LED temperature colour
 /1_ 2700 K
 CRI >90 616,83 lm 101 lm/W

Control
 6046 __ / __ 0
 On/ Off

Packaging

1 Box 0,29 x 0,38 x 0,38 m
 Vol 0,418 m³
 Gross weight 2,6 Kg Net weight 1,8 Kg



6050

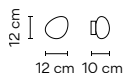

- Finishes
- 93/ __ White (RAL 9016)

Light Source and electronics

1 x LED 4,5W 350 mA
 Constant Current 350 mA
 100~240V 50/60Hz

LED temperature colour
 /1_ 2700 K
 CRI >90 485 lm 121 lm/W

Control
 6050 __ / __ 0
 On/ Off

Materials

Wall support: Aluminum.
 Diffuser: Blown-glass

Packaging

1 Box 0,13 x 0,20 x 0,21 m
 Vol 0,00055 m³
 Gross weight 0,6 Kg Net weight 0,4 Kg



Tube

Design by Ichiro Iwasaki

Shade Landscape. A fluid gesture outlines the tubes, which when set out over a space become the structure that facilitates a meeting of the shades in a harmonious coming together.

Ceiling Pendants

6100

ø 28,5 cm



6105

ø 41 cm



6110

ø 52 cm

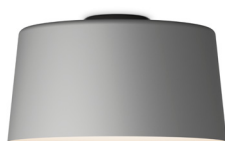

6115

97 cm



6160



ø 22 cm

6165



ø 28,5 cm

Each project is unique. Visit vibia.com and chose among multiple compositions designed and adapted to your project needs.

Personalise your own Tube composition quick and easy at vibia.com

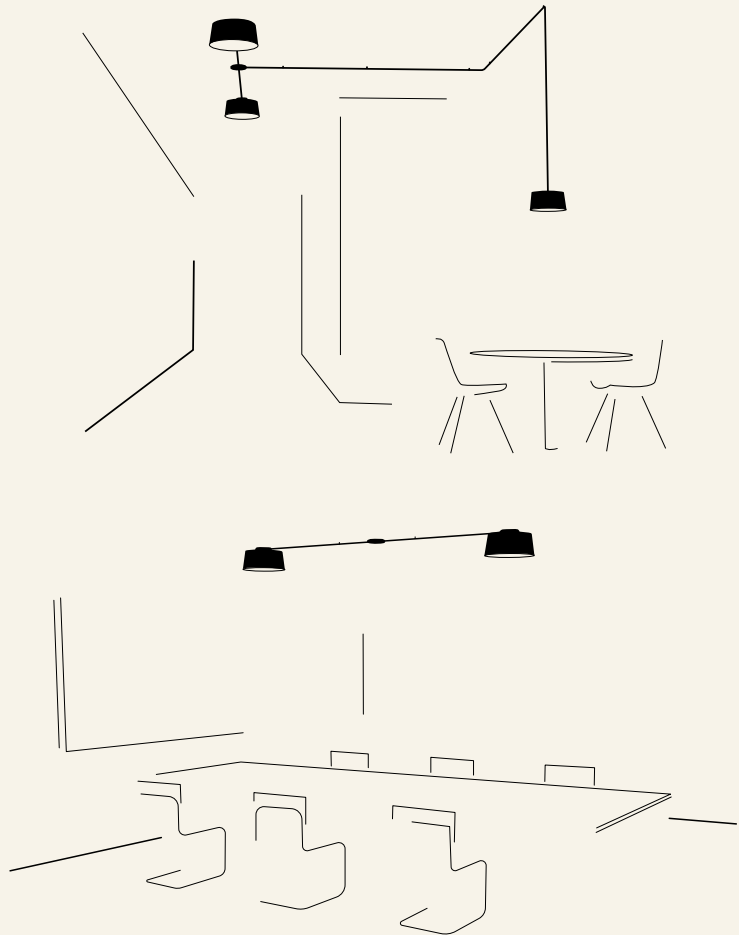

6100

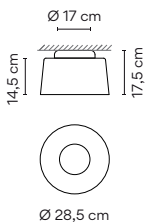

Finishes

- 10/ __ White (NCS S 0300-N)
- 15/ __ Grey L2 (NCS S 2500-N)
- 16/ __ Grey M1 (NCS S 4500-N)
- 21/ __ Black Grey (NCS S 7000-N)
- 24/ __ Beige M1 (NCS S 2005-Y50R)
- 37/ __ Terra Red (NCS S 4040-Y70R)

LED temperature colour

- /1_ 2700 K CRI >90 1476,7 lm 109 lm/W
- /2_ 3000 K CRI >90 1521,0 lm 113 lm/W
- /3_ 3500 K CRI >90 1550,6 lm 114,9 lm/W

Control

6100 __ / __ A
 DALI-2

Materials

Diffuser: Polycarbonate. Led support: Aluminum.
 Shade: Aluminum. Canopy: Steel.

Light Source and electronics

1 x LED PLATE 13,5 W 700 mA
 Constant Current 700 mA
 110-240V 50/60Hz

Packaging

1 Box 0,40 x 0,40 x 0,35 m
 Vol 0,056 m³
 Gross weight 4,5 Kg Net weight 2,5 Kg



6105

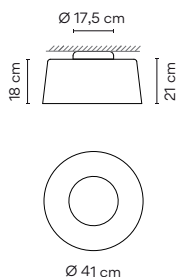

- | | |
|--|--|
| Finishes | LED temperature colour |
| <ul style="list-style-type: none"> ● 10/ __ White (NCS S 0300-N) ● 15/ __ Grey L2 (NCS S 2500-N) ● 16/ __ Grey M1 (NCS S 4500-N) ● 21/ __ Black Grey (NCS S 7000-N) ● 24/ __ Beige M1 (NCS S 2005-Y50R) ● 37/ __ Terra Red (NCS S 4040-Y70R) | <ul style="list-style-type: none"> /1 _ 2700 K CRI >90 2413,2 lm 121 lm/W /2 _ 3000 K CRI >90 2485,6 lm 124 lm/W /3 _ 3500 K CRI >90 2533,9 lm 126,7 lm/W |

Control
6105 __ / _ A
DALI-2

Materials
Diffuser: Polycarbonate. Led support: Aluminum.
Shade: Aluminum. Canopy: Steel.

Packaging
1 Box 0,60 x 0,60 x 0,40 m
Vol 0,144 m³
Gross weight 5,5 Kg Net weight 3,5 Kg

Light Source and electronics
1 x LED PLATE 20 W 700 mA
Constant Current 700 mA
110-240V 50/60Hz



6110

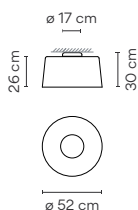

- | | |
|--|--|
| Finishes | LED temperature colour |
| <ul style="list-style-type: none"> ● 10/ __ White (NCS S 0300-N) ● 15/ __ Grey L2 (NCS S 2500-N) ● 16/ __ Grey M1 (NCS S 4500-N) ● 21/ __ Black Grey (NCS S 7000-N) ● 24/ __ Beige M1 (NCS S 2005-Y50R) ● 37/ __ Terra Red (NCS S 4040-Y70R) | <ul style="list-style-type: none"> /1 _ 2700 K CRI >90 3299,1 lm 132 lm/W /2 _ 3000 K CRI >90 3398,1 lm 136 lm/W /3 _ 3500 K CRI >90 3464,0 lm 138,6 lm/W |

Control
6110 __ / _ A
DALI-2

Materials
Diffuser: Polycarbonate. Led support: Aluminum.
Shade: Aluminum. Canopy: Steel.

Packaging
1 Box 0,60 x 0,60 x 0,40 m
Vol 0,144 m³
Gross weight 6,5 Kg Net weight 4,5 Kg

Light Source and electronics
1 x LED PLATE 25 W 700 mA
Constant Current 700 mA
110-240V 50/60Hz



6115

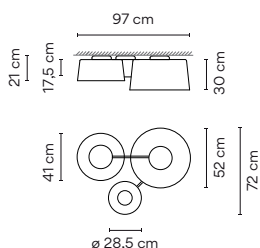

- | | |
|--|--|
| Finishes | LED temperature colour |
| <ul style="list-style-type: none"> ● 10/ __ White (NCS S 0300-N) ● 24/ __ Beige M1 (NCS S 2005-Y50R) ● 37/ __ Terra Red (NCS S 4040-Y70R) ● 71/ __ Grey L2, Grey M1, Black Grey (NCS S 2500-N, NCS S 4500-N, NCS S 7000-N) | <ul style="list-style-type: none"> /1 _ 2700 K CRI >90 7189,0 lm 123 lm/W /2 _ 3000 K CRI >90 7404,7 lm 127 lm/W /3 _ 3500 K CRI >90 7548,5 lm 129 lm/W |

Control
6115 __ / _ A
DALI-2

Materials
Diffuser: Polycarbonate. Led support: Aluminum.
Shade: Aluminum. Canopy: Steel.

Packaging
1 Box 1 x 1 x 0,40 m
Vol 0,40 m³
Gross weight 16 Kg Net weight 12 Kg

Light Source and electronics
1 x LED PLATE 13,5 W 700 mA
1 x LED PLATE 20 W 700 mA
1 x LED PLATE 25 W 700 mA
Constant Current 700 mA
110-240V 50/60Hz



6160

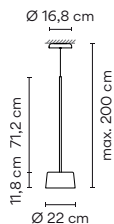

Finishes

- 10/ __ White (NCS S 0300-N)
- 15/ __ Grey L2 (NCS S 2500-N)
- 16/ __ Grey M1 (NCS S 4500-N)
- 21/ __ Black Grey (NCS S 7000-N)
- 24/ __ Beige M1 (NCS S 2005-Y50R)
- 37/ __ Terra Red (NCS S 4040-Y70R)

Finish customization
(Available options:
Vibia colour palette)

LED temperature colour

- /1 _ 2700 K CRI >90 1170 lm 111 lm/W
- /2 _ 3000 K CRI >90 1251 lm 119 lm/W
- /3 _ 3500 K CRI >90 1251 lm 119 lm/W

Control

6160 __ / _ 1
DALI

6160 __ / _ B
1-10V, Push

6160 __ / _ Z
Casambi

Materials

Diffuser: Polycarbonate. Shade: Aluminum.
Led support: Aluminum. Tube: Steel. Canopy: Steel.

Light Source and electronics

1 x LED PLATE 10,5 W
Constant Current 700 mA
110-240V 50/60Hz

Packaging

Total Vol 0,04 m3
Gross weight 4,2 Kg Net weight 1,6 Kg

Notes

Extra cable length.



Electrical connection

Surface
_18 Free Wire
_23 Built-in
_31 Remote
Micro
for plaster
ceilings
_32 Remote
XXS
for all types
of drop
ceilings

6165

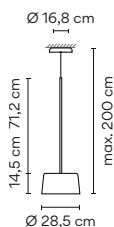

Finishes

- 10/ __ White (NCS S 0300-N)
- 15/ __ Grey L2 (NCS S 2500-N)
- 16/ __ Grey M1 (NCS S 4500-N)
- 21/ __ Black Grey (NCS S 7000-N)
- 24/ __ Beige M1 (NCS S 2005-Y50R)
- 37/ __ Terra Red (NCS S 4040-Y70R)

Finish customization
(Available options:
Vibia colour palette)

LED temperature colour

- /1 _ 2700 K CRI >90 1170 lm 111 lm/W
- /2 _ 3000 K CRI >90 1251 lm 119 lm/W
- /3 _ 3500 K CRI >90 1251 lm 119 lm/W

Control

6165 __ / _ 1
DALI

6165 __ / _ B
1-10V, Push

6165 __ / _ Z
Casambi

Materials

Diffuser: Polycarbonate. Shade: Aluminum.
Led support: Aluminum. Tube: Steel. Canopy: Steel.

Light Source and electronics

1 x LED PLATE 13,5 W
Constant Current 700 mA
110-240V 50/60Hz

Packaging

Total Vol 0,04 m3
Gross weight 4,3 Kg Net weight 1,7 Kg

Notes

Extra cable length.



Electrical connection

Surface
_18 Free Wire
_23 Built-in
_31 Remote
Micro
for plaster
ceilings
_32 Remote
XXS
for all types
of drop
ceilings

Composing pendants

Next sketches are composed by one or more compositions

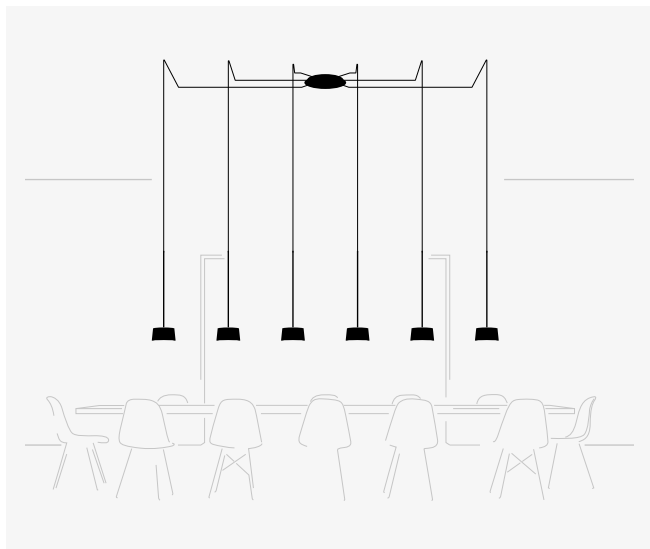

6 x 6165.

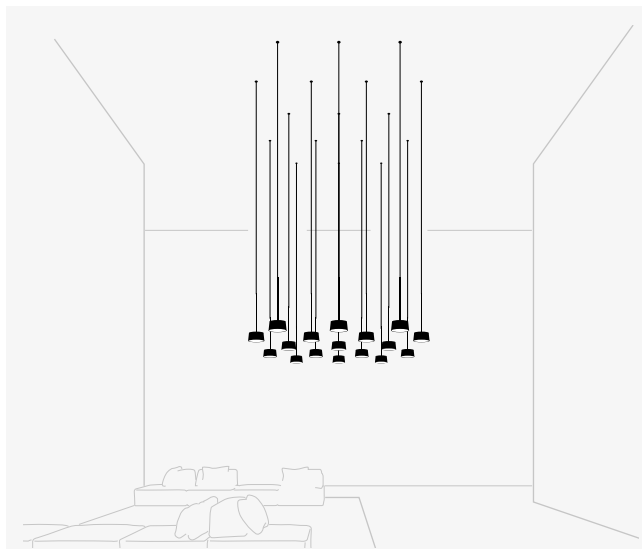

17 x 6160.

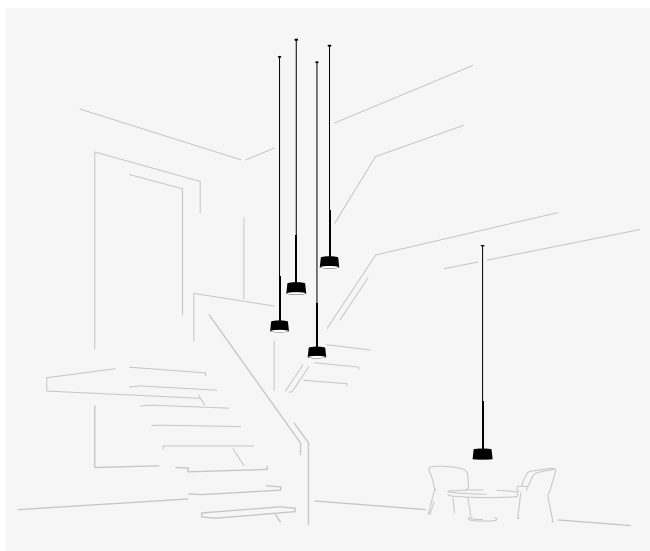

5 x 6160.

Each project is unique.
Visit vibia.com and
chose among multiple
compositions designed
and adapted to your
project needs.

Personalise your own
Tube composition quick
and easy at vibia.com



Electrical connection options for models 6160 / 6165

Choose your preferred installation option according to your needs. For each composition, the optimal minimum number of drivers will be delivered.

Drop ceiling

The innovative remote and built-in fittings accentuate the silkiness and lightness of compositions on suspended ceilings, its great visual grandeur taking center stage.

For Ref. 6160 / 6165

Remote

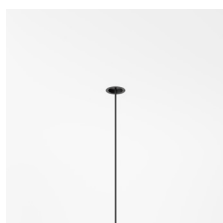

Micro \varnothing 3 cm
height 7 cm
for plaster ceilings.
Black finish.

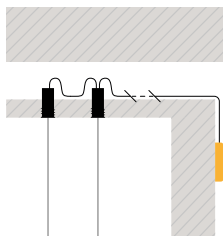

Built-in



\varnothing 8 cm
height 6 cm
match with
fixture finish.

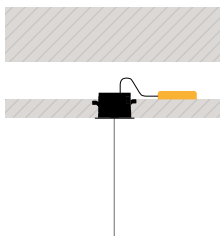

Regular ceiling

When architecture does not allow for performance, surface and free wire showcase possibilities for any need or desire with no limits, ideal for both individual or cluster arrangements.

For Ref. 6160 / 6165

Surface

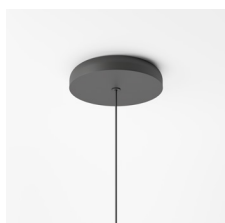

ø 16,8 cm
match with
fixture finish.

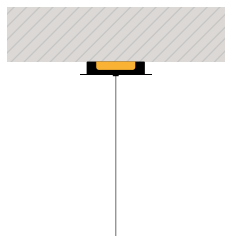

Free Wire

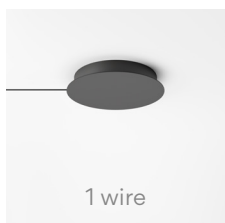

1 wire

ø 20 cm

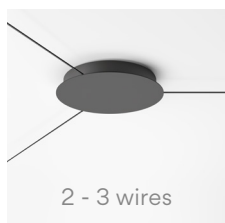

2 - 3 wires

ø 22 cm

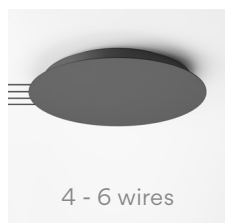

4 - 6 wires

ø 36 cm

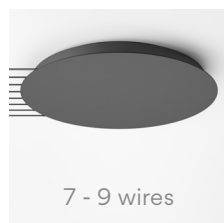

7 - 9 wires

ø 40 cm

you can choose the finish of the canopy
among black, white or any colour
matching one of the pendants.

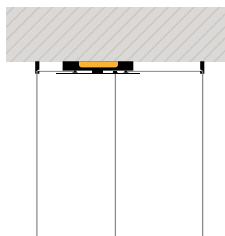

Plusminus

Design by Diez Office.

Plusminus is a versatile lighting system that takes the concept of the light rail to a new level.

The conductive textile ribbon at its core allows for free placement of the luminaires and the creation of unique light solutions on the spot.





Easy to design and install

Compose a personalised Plusminus at vibia.com

From scratch

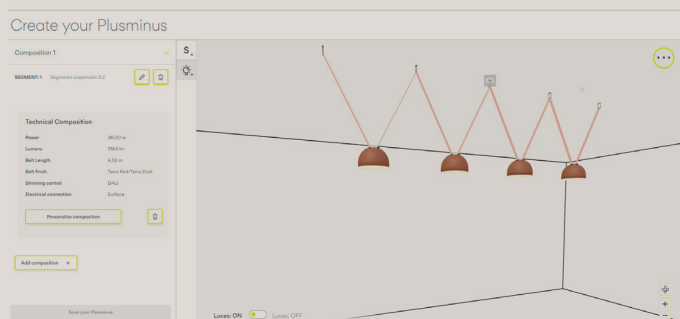

- + Create and compose projects in detail.
- + Draw and customise in 3D to see it in space.
- + Or customise it step by step without drawing.

From a layout

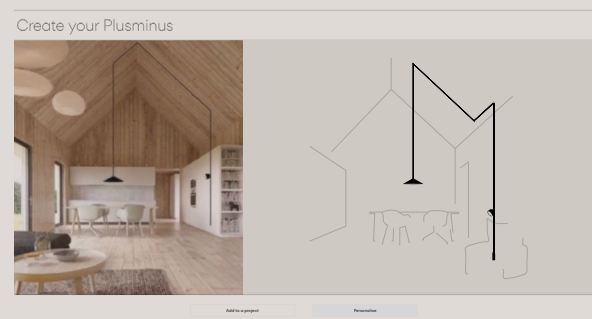

- + Customise and adapt it to the needs of your project.
- + Add it to your project and edit it at any time.
- + More than 100 creations for you.

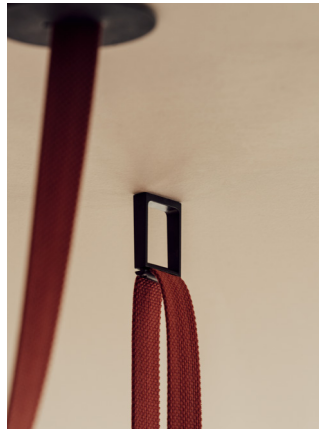
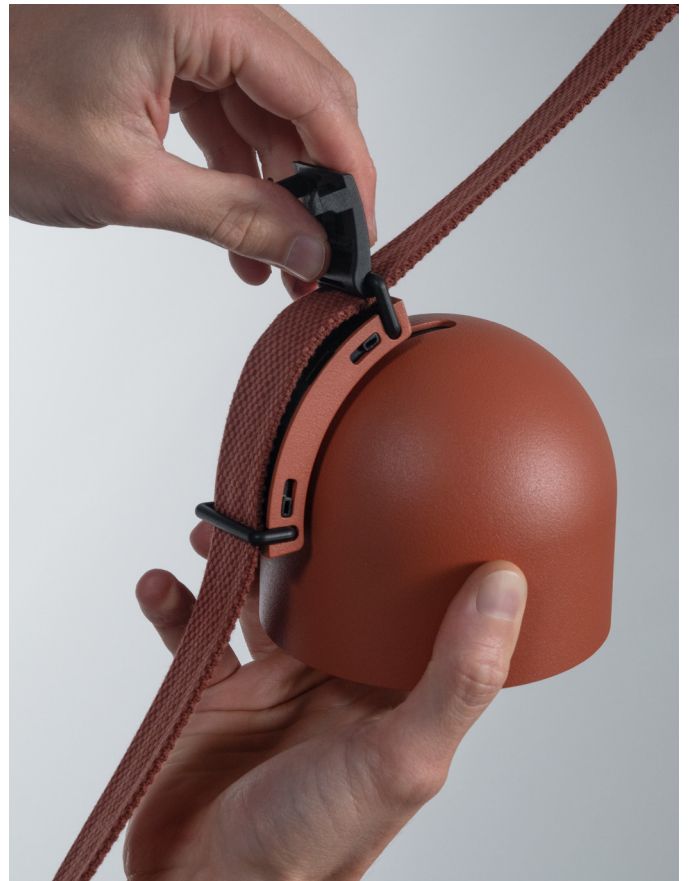

Easy connection Fix / Click / Connect

Each belt, which can be cut as needed, accommodates multiple luminaires and operates with simple plug-in technology for unparalleled ease of installation and connection. The belt offers adjustments in tension from taut to relaxed as well as click-and-connect functionality, snapping into a buckle attached to each luminaire.

Luminaire types and lighting effects



Sphere



360° Diffusion lighting distributes light equally in all directions (360°). It attracts a relaxed gaze towards the point of light, and creates a calm, very comfortable atmosphere. The light sphere bathes all surfaces of the space, producing a peaceful, richer and extremely homogenous ambience.



Semisphere



Directed diffusion lighting emits a soft light that generates low contrasts between the illuminated areas and the shadows cast. The opaque part of the shade helps to direct the light through the diffuser, providing illumination that is both peaceful and concentrated at the same time.



Cone



Directed diffusion lighting emits a soft light that generates low contrasts between the illuminated areas and the shadows cast. The opaque part of the shade helps to direct the light through the diffuser, providing illumination that is both peaceful and concentrated at the same time.

Spotlight

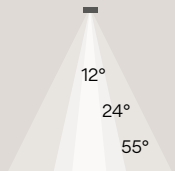

Directed diffusion lighting

emits a soft light that generates low contrasts between the illuminated areas and the shadows cast. It is ideal for reading situations or when the light output is visible, as it does not produce glare.

Accent lighting

emphasizes objects or architectural elements with intensive cones of light. Luminance contrasts attract the eye and bring the illuminated objects into the foreground. The light output is directed towards the object or architectural element and not towards the person, in order to avoid glare.



Linear Diffuser

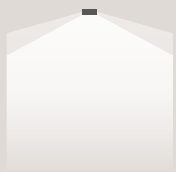

General lighting

provides a high degree of uniformity on the horizontal plane and generates a first layer of illumination on which to add more specific lighting applications. It generates soft shadows and subdued brightness in which the space and its component elements do not display visual hierarchies.



Linear Low UGR



High-efficiency, low-glare general linear lighting

offers medium brightness and clarity of forms. Direct illumination, extended beam and luminaire performance enable installations with high-energy efficiencies and low-glare levels below UGR<19.

High-comfort, low-glare general linear lighting

provides high levels of illumination and comfort with UGR levels below 19. It is also ideal for work or meeting areas.



Luminaire types

It is not possible to order luminaires alone, you need to design your Plusminus on our website vibia.com

Sphere



Ø 20 cm

6230



Ø 30 cm

6235

6230

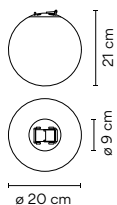

- Finishes**
- **11/** _ _ Black (NCS S 8500-N)
 - **24/** _ _ Beige M1 (NCS S 2005-Y50R)
 - **37/** _ _ Terra Red (NCS S 4040-Y70R)
 - **42/** _ _ Blue M1 (NCS S 5010-B10G)
 - **53/** _ _ Green M1 (NCS S 6005-G80Y)

- LED temperature colour**
- /1** _ 2700 K CRI >90 846 lm 107,09 lm/W
 - /2** _ 3000 K CRI >90 884 lm 111,9 lm/W
 - /3** _ 3500 K CRI >90 916 lm 115,95 lm/W

- Control**
- 6230** _ _ / _ **O**
On/ Off
 - 6230** _ _ / _ **F**
Simultaneous line
DALI, 1-10V, Push, Casambi
 - 6230** _ _ / _ **Z**
Casambi integrated on each individual luminaire (P2P)

Materials
Diffuser: Triplex opal glass.
Body: Aluminum.

Light Source and electronics
1 x LED 7,9 W 450 mA

Packaging
1 Box 0,26 x 0,26 x 0,260 m
Vol 0,0175 m³
Gross weight 1,56 Kg Net weight 0,93 Kg



6235

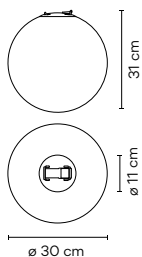

- Finishes**
- **11/** _ _ Black (NCS S 8500-N)
 - **24/** _ _ Beige M1 (NCS S 2005-Y50R)
 - **37/** _ _ Terra Red (NCS S 4040-Y70R)
 - **42/** _ _ Blue M1 (NCS S 5010-B10G)
 - **53/** _ _ Green M1 (NCS S 6005-G80Y)

- LED temperature colour**
- /1** _ 2700 K CRI >90 1492 lm 93,25 lm/W
 - /2** _ 3000 K CRI >90 1569 lm 98,06 lm/W
 - /3** _ 3500 K CRI >90 1606 lm 100,38 lm/W

- Control**
- 6235** _ _ / _ **O**
On/ Off
 - 6235** _ _ / _ **F**
Simultaneous line
DALI, 1-10V, Push, Casambi
 - 6235** _ _ / _ **Z**
Casambi integrated on each individual luminaire (P2P)

Materials
Diffuser: Triplex opal glass.
Body: Aluminum.

Light Source and electronics
1 x LED 16 W 850 mA

Packaging
1 Box 0,364 x 0,364 x 0,364 m
Vol 0,0482 m³
Gross weight 2,50 Kg Net weight 1,80 Kg



Semisphere



Ø 20 cm

6220



Ø 30 cm

6225

6220

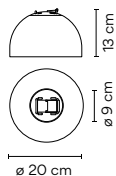

- Finishes**
- 11/ _ _ Black (NCS S 8500-N)
 - 24/ _ _ Beige M1 (NCS S 2005-Y50R)
 - 37/ _ _ Terra Red (NCS S 4040-Y70R)
 - 42/ _ _ Blue M1 (NCS S 5010-B10G)
 - 53/ _ _ Green M1 (NCS S 6005-G80Y)

- LED temperature colour**
- /1 _ 2700 K CRI >90 846 lm 107,09 lm/W
 - /2 _ 3000 K CRI >90 884 lm 111,9 lm/W
 - /3 _ 3500 K CRI >90 916 lm 115,95 lm/W

- Control**
- 6220 _ _ / _ 0
On/ Off
-
- 6220 _ _ / _ F
Simultaneous line
DALI, 1-10V, Push, Casambi
-
- 6220 _ _ / _ Z
Casambi integrated on each individual luminaire (P2P)

Materials
 Shade: Aluminum.
 Diffuser: Polycarbonate.

Light Source and electronics
 1 x LED 7,9 W 450 mA

Packaging
 1 Box 0,26 x 0,26 x 0,26 m
 Vol 0,0175 m³
 Gross weight 1,20 Kg Net weight 0,78 Kg



6225

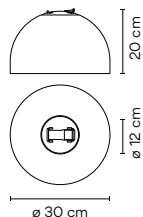

- Finishes**
- 11/ _ _ Black (NCS S 8500-N)
 - 24/ _ _ Beige M1 (NCS S 2005-Y50R)
 - 37/ _ _ Terra Red (NCS S 4040-Y70R)
 - 42/ _ _ Blue M1 (NCS S 5010-B10G)
 - 53/ _ _ Green M1 (NCS S 6005-G80Y)

- LED temperature colour**
- /1 _ 2700 K CRI >90 1492 lm 93,25 lm/W
 - /2 _ 3000 K CRI >90 1569 lm 98,06 lm/W
 - /3 _ 3500 K CRI >90 1606 lm 100,38 lm/W

- Control**
- 6225 _ _ / _ 0
On/ Off
-
- 6225 _ _ / _ F
Simultaneous line
DALI, 1-10V, Push, Casambi
-
- 6225 _ _ / _ Z
Casambi integrated on each individual luminaire (P2P)

Materials
 Shade: Aluminum.
 Diffuser: Polycarbonate.

Light Source and electronics
 1 x LED 16 W 850 mA

Packaging
 1 Box 0,364 x 0,364 x 0,364 m
 Vol 0,0482 m³
 Gross weight 2 Kg Net weight 1,5 Kg



Luminaire types

It is not possible to order luminaires alone, you need to design your Plusminus on our website vibia.com

Cone



Ø 60 cm

6240



Ø 80 cm

6245

6240

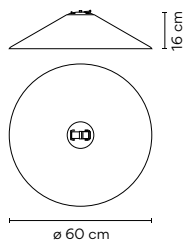

- Finishes**
- **11/** __ Black (NCS S 8500-N)
 - **24/** __ Beige M1 (NCS S 2005-Y50R)
 - **37/** __ Terra Red (NCS S 4040-Y70R)
 - **42/** __ Blue M1 (NCS S 5010-B10G)
 - **53/** __ Green M1 (NCS S 6005-G80Y)

- LED temperature colour**
- /1 _ 2700 K CRI >90 1492 lm 93,25 lm/W
 - /2 _ 3000 K CRI >90 1569 lm 98,06 lm/W
 - /3 _ 3500 K CRI >90 1606 lm 100,38 lm/W

- Control**
- 6240** __ / __ **O**
On/ Off
-
- 6240** __ / __ **F**
Simultaneous line
DALI, 1-10V, Push, Casambi
-
- 6240** __ / __ **Z**
Casambi integrated on each individual luminaire (P2P)

Materials
Shade: Aluminum.
Diffuser: Triplex opal glass.
Light Source and electronics
1 x LED 16 W 850 mA

Packaging
0,727 x 0,727 x 0,32 m
Vol 0,1691 m³
Gross weight 5 Kg Net weight 2,5 Kg



6245

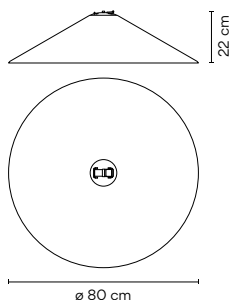

- Finishes**
- **11/** __ Black (NCS S 8500-N)
 - **24/** __ Beige M1 (NCS S 2005-Y50R)
 - **37/** __ Terra Red (NCS S 4040-Y70R)
 - **42/** __ Blue M1 (NCS S 5010-B10G)
 - **53/** __ Green M1 (NCS S 6005-G80Y)

- LED temperature colour**
- /1 _ 2700 K CRI >90 1492 lm 93,25 lm/W
 - /2 _ 3000 K CRI >90 1569 lm 98,06 lm/W
 - /3 _ 3500 K CRI >90 1606 lm 100,38 lm/W

- Control**
- 6245** __ / __ **O**
On/ Off
-
- 6245** __ / __ **F**
Simultaneous line
DALI, 1-10V, Push, Casambi
-
- 6245** __ / __ **Z**
Casambi integrated on each individual luminaire (P2P)

Materials
Shade: Aluminum.
Diffuser: Triplex opal glass.
Light Source and electronics
1 x LED 16 W 850 mA

Packaging
1 Box 0,96 x 0,96 x 0,27 m
Vol 0,2488 m³
Gross weight 7 Kg Net weight 3,5 Kg



Spotlight



Ø 10 cm

6200



Ø 10 cm

6205 6210



Ø 10 cm

6215

6200

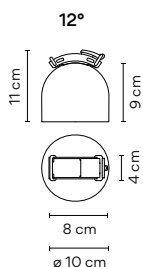

- Finishes**
- 11/ __ Black (NCS S 8500-N)
 - 24/ __ Beige M1 (NCS S 2005-Y50R)
 - 37/ __ Terra Red (NCS S 4040-Y70R)
 - 42/ __ Blue M1 (NCS S 5010-B10G)
 - 53/ __ Green M1 (NCS S 6005-G80Y)

- LED temperature colour**
- /1 _ 2700 K CRI >90 846 lm 107,09 lm/W
 - /2 _ 3000 K CRI >90 884 lm 111,9 lm/W
 - /3 _ 3500 K CRI >90 916 lm 115,95 lm/W

- Control**
- 6200 __ / _ 0
On/ Off
-
- 6200 __ / _ F
Simultaneous line
DALI, 1-10V, Push, Casambi
-
- 6200 __ / _ Z
Casambi integrated on each individual luminaire (P2P)

Materials
 Shade: Aluminum.
 Diffuser: Polycarbonate.

Light Source and electronics
 1 x LED 7,9 W 450 mA

Packaging
 1 Box 0,193 x 0,161 x 0,148 m
 Vol 0,0046 m³
 Gross weight 0,719 Kg Net weight 0,51 Kg



Bi-volt Dimmer

6205

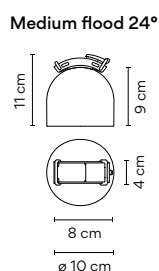

- Finishes**
- 11/ __ Black (NCS S 8500-N)
 - 24/ __ Beige M1 (NCS S 2005-Y50R)
 - 37/ __ Terra Red (NCS S 4040-Y70R)
 - 42/ __ Blue M1 (NCS S 5010-B10G)
 - 53/ __ Green M1 (NCS S 6005-G80Y)

- LED temperature colour**
- /1 _ 2700 K CRI >90 846 lm 107,09 lm/W
 - /2 _ 3000 K CRI >90 884 lm 111,9 lm/W
 - /3 _ 3500 K CRI >90 916 lm 115,95 lm/W

- Control**
- 6205 __ / _ 0
On/ Off
-
- 6205 __ / _ F
Simultaneous line
DALI, 1-10V, Push, Casambi
-
- 6205 __ / _ Z
Casambi integrated on each individual luminaire (P2P)

Materials
 Shade: Aluminum.
 Diffuser: Polycarbonate.

Light Source and electronics
 1 x LED 7,9 W 450 mA

Packaging
 1 Box 0,193 x 0,161 x 0,148 m
 Vol 0,0046 m³
 Gross weight 0,719 Kg Net weight 0,51 Kg



Bi-volt Dimmer

Luminaire types

It is not possible to order luminaires alone, you need to design your Plusminus on our website vibia.com

6210

Wide flood 55°

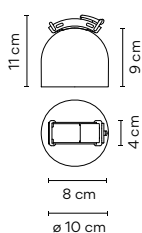

- | | |
|--|--|
| Finishes | LED temperature colour |
| ● 11/ __ Black
(NCS S 8500-N) | /1 _ 2700 K CRI >90 846 lm 107,09 lm/W |
| ● 24/ __ Beige M1
(NCS S 2005-Y50R) | /2 _ 3000 K CRI >90 884 lm 111,9 lm/W |
| ● 37/ __ Terra Red
(NCS S 4040-Y70R) | /3 _ 3500 K CRI >90 916 lm 115,95 lm/W |
| ● 42/ __ Blue M1
(NCS S 5010-B10G) | |
| ● 53/ __ Green M1
(NCS S 6005-G80Y) | |

- Control**
- 6210** __ / _ **0**
On/ Off
-
- 6210** __ / _ **F**
Simultaneous line
DALI, 1-10V, Push, Casambi
-
- 6210** __ / _ **Z**
Casambi integrated on each individual luminaire (P2P)

Materials
Shade: Aluminum.
Diffuser: Polycarbonate.

Packaging
1 Box 0,193 x 0,161 x 0,148 m
Vol 0,0046 m³
Gross weight 0,719 Kg Net weight 0,51 Kg

Light Source and electronics
1 x LED 7,9 W 450 mA



Bi-volt Dimmer

6215

Directed diffusion lighting

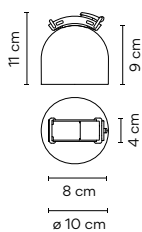

- | | |
|--|--|
| Finishes | LED temperature colour |
| ● 11/ __ Black
(NCS S 8500-N) | /1 _ 2700 K CRI >90 491 lm 116,9 lm/W |
| ● 24/ __ Beige M1
(NCS S 2005-Y50R) | /2 _ 3000 K CRI >90 513 lm 122,14 lm/W |
| ● 37/ __ Terra Red
(NCS S 4040-Y70R) | /3 _ 3500 K CRI >90 532 lm 126,67 lm/W |
| ● 42/ __ Blue M1
(NCS S 5010-B10G) | |
| ● 53/ __ Green M1
(NCS S 6005-G80Y) | |

- Control**
- 6215** __ / _ **0**
On/ Off
-
- 6215** __ / _ **F**
Simultaneous line
DALI, 1-10V, Push, Casambi
-
- 6215** __ / _ **Z**
Casambi integrated on each individual luminaire (P2P)

Materials
Shade: Aluminum.
Diffuser: Polycarbonate.

Packaging
1 Box 0,193 x 0,161 x 0,148 m
Vol 0,0046 m³
Gross weight 0,719 Kg Net weight 0,51 Kg

Light Source and electronics
1 x LED 4,2 W 250 mA



Bi-volt Dimmer

Accent lighting



Directed diffusion lighting

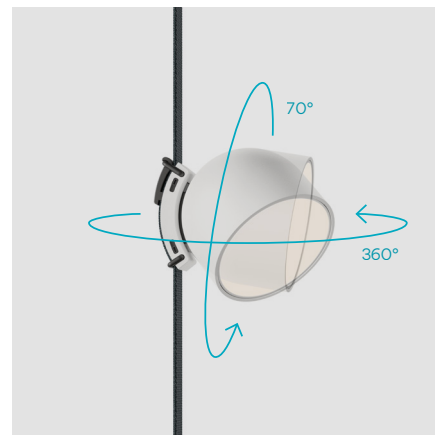

Linear diffuser

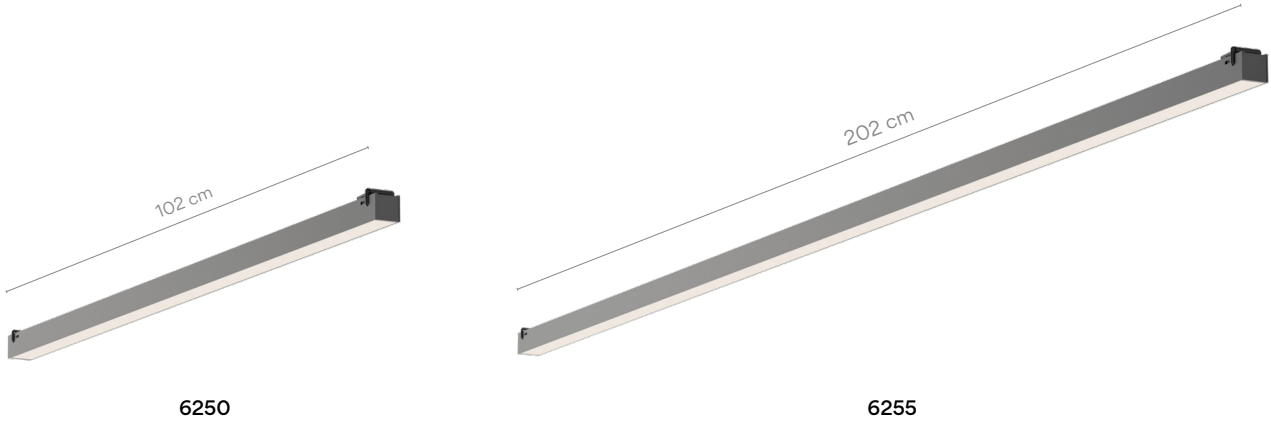

6250

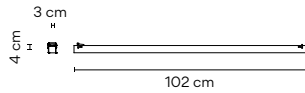

Finishes	LED temperature colour	Control
● 11/ __ Black (NCS S 8500-N)	/1 2700 K CRI >90 2544 lm 123,5 lm/W	6250 __ / __ O On/ Off
● 24/ __ Beige M1 (NCS S 2005-Y50R)	/2 3000 K CRI >90 2628 lm 127,57 lm/W	6250 __ / __ F Simultaneous line DALI, 1-10V, Push, Casambi
● 37/ __ Terra Red (NCS S 4040-Y70R)	/3 3500 K CRI >90 2712 lm 131,65 lm/W	6250 __ / __ Z Casambi integrated on each individual luminaire (P2P)
● 42/ __ Blue M1 (NCS S 5010-B10G)		
● 53/ __ Green M1 (NCS S 6005-G80Y)		
Materials	Packaging	
Shade: Aluminum. Diffuser: Polycarbonate.	1 Box 0,06 x 0,06 x 1,25 m Vol 0,0057 m ³ Gross weight 1,5 Kg Net weight 0,72 Kg	
Light Source and electronics		
1 x LED STRIP 20,6 W 24 V		

6255

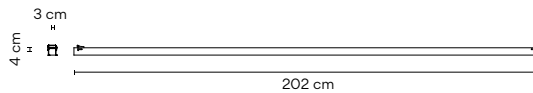

Finishes	LED temperature colour	Control
● 11/ __ Black (NCS S 8500-N)	/1 2700 K D CRI >90 5088 lm 123,5 lm/W	6255 __ / __ O On/ Off
● 24/ __ Beige M1 (NCS S 2005-Y50R)	/2 3000 K D CRI >90 5256 lm 127,57 lm/W	6255 __ / __ F Simultaneous line DALI, 1-10V, Push, Casambi
● 37/ __ Terra Red (NCS S 4040-Y70R)	/3 3500 K D CRI >90 5424 lm 131,65 lm/W	6255 __ / __ Z Casambi integrated on each individual luminaire (P2P)
● 42/ __ Blue M1 (NCS S 5010-B10G)		
● 53/ __ Green M1 (NCS S 6005-G80Y)		
Materials	Packaging	
Shade: Aluminum. Diffuser: Polycarbonate.	1 Box 0,06 x 0,06 x 2,24 m Vol 0,0103 m ³ Gross weight 2 Kg Net weight 1,45 Kg	
Light Source and electronics		
1 x LED STRIP 41,3 W 24 V		

Linear Low UGR
High-Comfort



6260

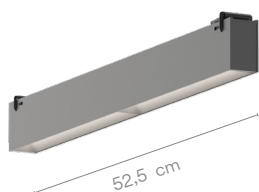

6265

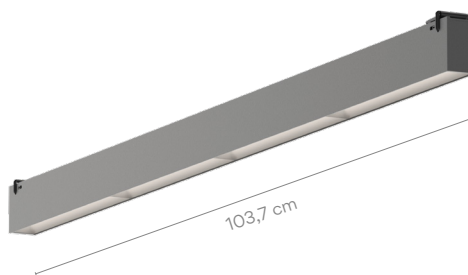

6270



6260

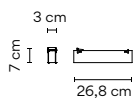

- Finishes**
- **11/** _ _ Black
(NCS S 8500-N)
 - **24/** _ _ Beige M1
(NCS S 2005-Y50R)
 - **37/** _ _ Terra Red
(NCS S 4040-Y70R)
 - **42/** _ _ Blue M1
(NCS S 5010-B10G)
 - **53/** _ _ Green M1
(NCS S 6005-G80Y)

- LED temperature colour**
- /1** _ 2700 K
CRI >90 1281 lm 124,37 lm/W
 - /2** _ 3000 K
CRI >90 1323 lm 128,45 lm/W
 - /3** _ 3500 K
CRI >90 1366 lm 132,62 lm/W

- Control**
- 6260** _ _ / _ **O**
On/ Off
 - 6260** _ _ / _ **F**
Simultaneous line
DALI, 1-10V, Push, Casambi
 - 6260** _ _ / _ **Z**
Casambi integrated on each
individual luminaire (P2P)

Materials
Shade: Aluminum.
Diffuser: PET.

Light Source and electronics
1 x LED STRIP 20,6 W 24 V

Packaging
1 Box 0,08 x 0,11 x 0,32 m
Vol 0,0028 m³
Gross weight 0,8 Kg Net weight 0,41 Kg

Notes
UGR <19



6265

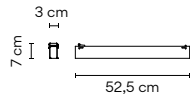

- Finishes**
- **11/** __ Black
(NCS S 8500-N)
 - **24/** __ Beige M1
(NCS S 2005-Y50R)
 - **37/** __ Terra Red
(NCS S 4040-Y70R)
 - **42/** __ Blue M1
(NCS S 5010-B10G)
 - **53/** __ Green M1
(NCS S 6005-G80Y)

- LED temperature colour**
- /1** _ 2700 K
CRI >90 2562 lm 124,37 lm/W
 - /2** _ 3000 K
CRI >90 2647 lm 128,5 lm/W
 - /3** _ 3500 K
CRI >90 2731 lm 132,57 lm/W

- Control**
- 6265** __ / __ **0**
On/ Off
 - 6265** __ / __ **F**
Simultaneous line
DALI, 1-10V, Push, Casambi
 - 6265** __ / __ **Z**
Casambi integrated on each
individual luminaire (P2P)

Materials
 Shade: Aluminum.
 Diffuser: PET.

Light Source and electronics
 1 x LED STRIP 20,6 W 24 V

Packaging
 1 Box 0,08 x 0,11 x 0,57 m
 Vol 0,0050 m³
 Gross weight 1,5 Kg Net weight 0,89 Kg

- Notes**
 UGR <19
-
-

6270

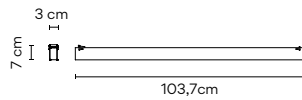

- Finishes**
- **11/** __ Black
(NCS S 8500-N)
 - **24/** __ Beige M1
(NCS S 2005-Y50R)
 - **37/** __ Terra Red
(NCS S 4040-Y70R)
 - **42/** __ Blue M1
(NCS S 5010-B10G)
 - **53/** __ Green M1
(NCS S 6005-G80Y)

- LED temperature colour**
- /1** _ 2700 K
CRI >90 5124 lm 124,07 lm/W
 - /2** _ 3000 K
CRI >90 5293 lm 128,16 lm/W
 - /3** _ 3500 K
CRI >90 5462 lm 132,25 lm/W

- Control**
- 6270** __ / __ **0**
On/ Off
 - 6270** __ / __ **F**
Simultaneous line
DALI, 1-10V, Push, Casambi
 - 6270** __ / __ **Z**
Casambi integrated on each
individual luminaire (P2P)

Materials
 Shade: Aluminum.
 Diffuser: PET.

Light Source and electronics
 1 x LED STRIP 41,3 W 24 V

Packaging
 1 Box 0,08 x 0,11 x 1,10 m
 Vol 0,0096 m³
 Gross weight 2,5 Kg Net weight 1,5 Kg

- Notes**
 UGR <19
-
-

Linear Low UGR
High-Efficiency

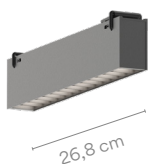

6275

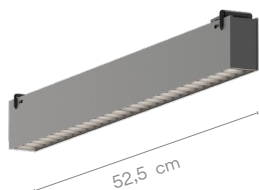

6280

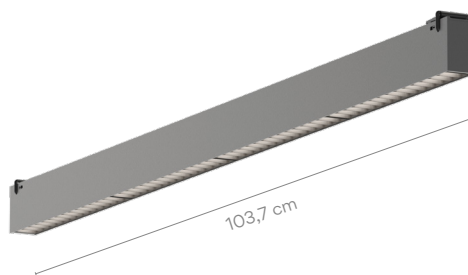

6285

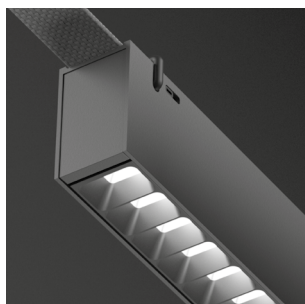

6275

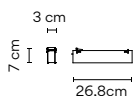

- Finishes**
- **11/** _ _ Black
(NCS S 8500-N)
 - **24/** _ _ Beige M1
(NCS S 2005-Y50R)
 - **37/** _ _ Terra Red
(NCS S 4040-Y70R)
 - **42/** _ _ Blue M1
(NCS S 5010-B10G)
 - **53/** _ _ Green M1
(NCS S 6005-G80Y)

- LED temperature colour**
- /1** _ 2700 K CRI >90 1281 lm 124,37 lm/W
 - /2** _ 3000 K CRI >90 1323 lm 128,45 lm/W
 - /3** _ 3500 K CRI >90 1366 lm 132,62 lm/W

- Control**
- 6275** _ _ / _ **0**
On/ Off
 - 6275** _ _ / _ **F**
Simultaneous line
DALI, 1-10V, Push, Casambi
 - 6275** _ _ / _ **Z**
Casambi integrated on each
individual luminaire (P2P)

Materials
Shade: Aluminum.

Light Source and electronics
1 x LED STRIP 10,3 W 24 V

Packaging
1 Box 0,08 x 0,11 x 0,32 m
Vol 0,0028 m³
Gross weight 0,8 Kg Net weight 0,41 Kg

Notes
UGR <19



6280

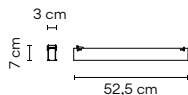

- Finishes**
- 11/ __ Black (NCS S 8500-N)
 - 24/ __ Beige M1 (NCS S 2005-Y50R)
 - 37/ __ Terra Red (NCS S 4040-Y70R)
 - 42/ __ Blue M1 (NCS S 5010-B10G)
 - 53/ __ Green M1 (NCS S 6005-G80Y)

- LED temperature colour**
- /1_ 2700 K CRI >90 2562 lm 124,37 lm/W
 - /2_ 3000 K CRI >90 2647 lm 128,5 lm/W
 - /3_ 3500 K CRI >90 2731 lm 132,57 lm/W

- Control**
- 6280 __ / __ 0 On/ Off
 - 6280 __ / __ F Simultaneous line DALI, 1-10V, Push, Casambi
 - 6280 __ / __ Z Casambi integrated on each individual luminaire (P2P)

Materials
 Shade: Aluminum.
Light Source and electronics
 1 x LED STRIP 20,6 W 24 V

Packaging
 1 Box 0,08 x 0,11 x 0,57 m
 Vol 0,0050 m³
 Gross weight 1,5 Kg Net weight 0,89 Kg

Notes
 UGR <19

6285

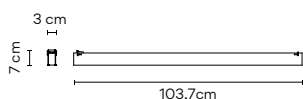

- Finishes**
- 11/ __ Black (NCS S 8500-N)
 - 24/ __ Beige M1 (NCS S 2005-Y50R)
 - 37/ __ Terra Red (NCS S 4040-Y70R)
 - 42/ __ Blue M1 (NCS S 5010-B10G)
 - 53/ __ Green M1 (NCS S 6005-G80Y)

- LED temperature colour**
- /1_ 2700 K CRI >90 5124 lm 124,07 lm/W
 - /2_ 3000 K CRI >90 5293 lm 128,16 lm/W
 - /3_ 3500 K CRI >90 5462 lm 132,25 lm/W

- Control**
- 6285 __ / __ 0 On/ Off
 - 6285 __ / __ F Simultaneous line DALI, 1-10V, Push, Casambi
 - 6285 __ / __ Z Casambi integrated on each individual luminaire (P2P)

Materials
 Shade: Aluminum.
Light Source and electronics
 1 x LED STRIP 41,3 W 24V

Packaging
 1 Box 0,08 x 0,11 x 1,102 m
 Vol 0,0096 m³
 Gross weight 2,5 Kg Net weight 1,5 Kg

Notes
 UGR <19

Accessories Toolbox

Thought out to the smallest detail.
Receive your personalised accessories
toolbox for a quick and easy installation.



Installation accessories

You will receive a personalised accessories toolbox per every composition made at vibia.com. The Toolbox includes some extra units for on-site adjustments.

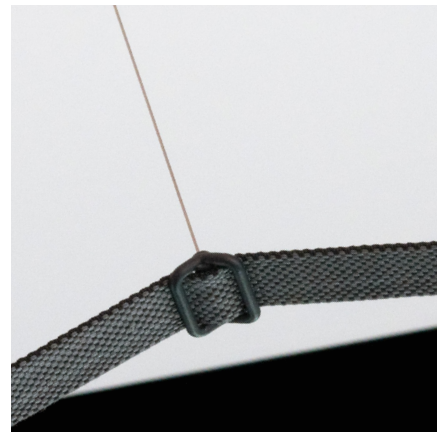

Belt terminations options

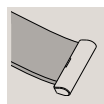

B3
Belt End Cap



B4
Double End Cap

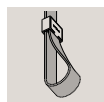

B5
Pendant End Cap

Fasten accessories options



F1
Circular Ratchet

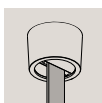

F2
Circular Anchor

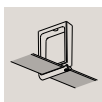

F3
Belt Support



F4
Counterweight

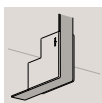

F5
Corner Support



F6
Freestyle Bar
2 m. bar length
5 m. maximum tensor cable

Tension clips options

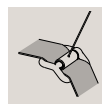

T1
Suspension Clip



T2
V-Tension Clip

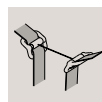

T3
Parallel Tension Clip S



T4
Parallel Tension Clip M



T5
Cable End Cap

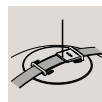

T6
Pendant Cable S



T7
Pendant Cable M

Materials

Counterweight: Cast iron

Finishes

11 Black (NCS S 0300-N)

Electrical connection options

Choose your preferred installation option according to your needs.



Surface



Built-in



Remote
Built-in



Surface

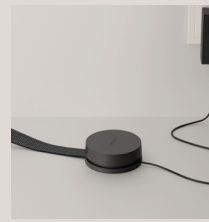

Plug



Optional wire
connector

Dimming control options

Choose your preferred installation option according to your needs.

Dimming Control

Electrical Connection

	Surface	Built-in	Remote	Plug
	25 - 240 W	25 - 240 W	25 - 240 W	Max 60W
On/ Off	✓	✓	✓	✓
Push Switch	—	—	—	✓
Push Simultaneous	✓	✓	✓	—
1-10V Simultaneous	✓	✓	✓	—
DALI Simultaneous	✓	✓	✓	—
Casambi Simultaneous	✓	✓	✓	✓
Casambi integrated on each individual luminaire (P2P)	✓	✓	✓	✓

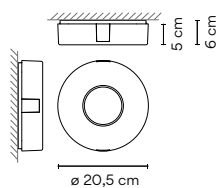

Surface Canopy S
E1 Ø 205 mm.
Wattage options:
< 60W.

Driver Constant Voltage 42V.
90-305 VAC. 100-240V. 50/60Hz.

Dimming options:
On/ Off.
Simultaneous line DALI / 1-10V / Push / Casambi.
Casambi integrated on each individual luminaire (P2P).

Body: ABS.
Net weight 0,9 Kg.

11 Black
(NCS S 8500-N)

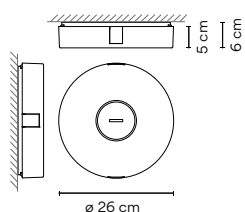

Surface Canopy M
E2 Ø 260 mm.
Wattage options:
>60W.
<240W.

Driver Constant Voltage 42V.
90-305 VAC. 100-240V. 50/60Hz.

Dimming options:
On/ Off.
Simultaneous line DALI / 1-10V / Push / Casambi.
Casambi integrated on each individual luminaire (P2P).

Body: ABS.
Net weight 1,8 Kg.

11 Black
(NCS S 8500-N)

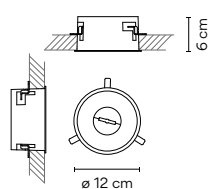

Built-in Canopy
E3 Ø 120 mm.
Wattage options:
>25W.
<240W.

Driver Constant Voltage 42V.
90-305 VAC. 100-240V. 50/60Hz.

Dimming options:
On/ Off.
Simultaneous line DALI / 1-10V / Push / Casambi.
Casambi integrated on each individual luminaire (P2P).

Body: ABS.
Net weight 1,08 - 1,860 Kg.

11 Black
(NCS S 8500-N)

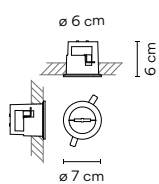

Remote Built-in Canopy
E4 Ø 60 mm.
Wattage options:
>25W.
<240W.

Driver Constant Voltage 42V.
90-305 VAC. 100-240V. 50/60Hz.

Dimming options:
On/ Off.
Simultaneous line DALI / 1-10V / Push / Casambi.
Casambi integrated on each individual luminaire (P2P).

Body: ABS.
Net weight 0,87 - 1,65 Kg.

11 Black
(NCS S 8500-N)

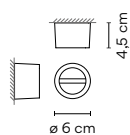

Remote Surface Canopy
E5 Ø 60 mm.
Wattage options:
>25W.
<240W.

Driver Constant Voltage 42V.
90-305 VAC. 100-240V. 50/60Hz.

Dimming options:
On/ Off.
Simultaneous line DALI / 1-10V / Push / Casambi.
Casambi integrated on each individual luminaire (P2P).

Body: Aluminum.
Net weight 0,95 - 1,73 Kg.

11 Black
(NCS S 8500-N)

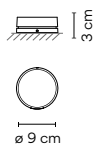

Plug-in Floor Switch
E6 Ø 90 mm.
Wattage options:
< 60W.

Driver Constant Voltage 42V.
90-305 VAC. 100-240V. 50/60Hz.

Dimming options:
On/ Off.
Push.
Casambi P2P.

Body: ABS.

11 Black
(NCS S 8500-N)

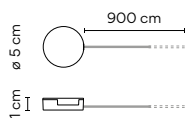

Wire Connector
E8 Ø 3,1 mm.
Wattage options:
< 60W.
Wire connector
E8 Ø 5,8 mm.
Wattage options:
< 60W.
<240W.

Driver Constant Voltage 42V.
90-305 VAC. 50/60Hz.

Body: ABS.

11 Black
(NCS S 8500-N)

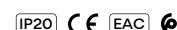

Belt

Maximum 60 metres per electrical connection, belt length personalised for each composition on www.vibia.com

Finishes	Belt	Fire Hazard Testing. GW-960.
Black Terra Red Blue Beige	Polyester	fulfills the requirements of: standards EN 60695-2-10:2013; EN 60695-2-11:2015; EN 60695-2-12:2011 / A1:2014

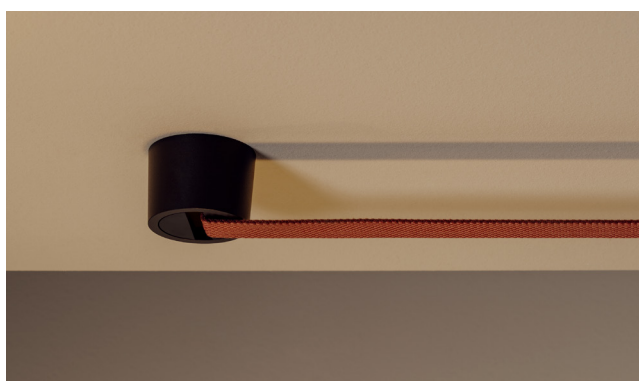
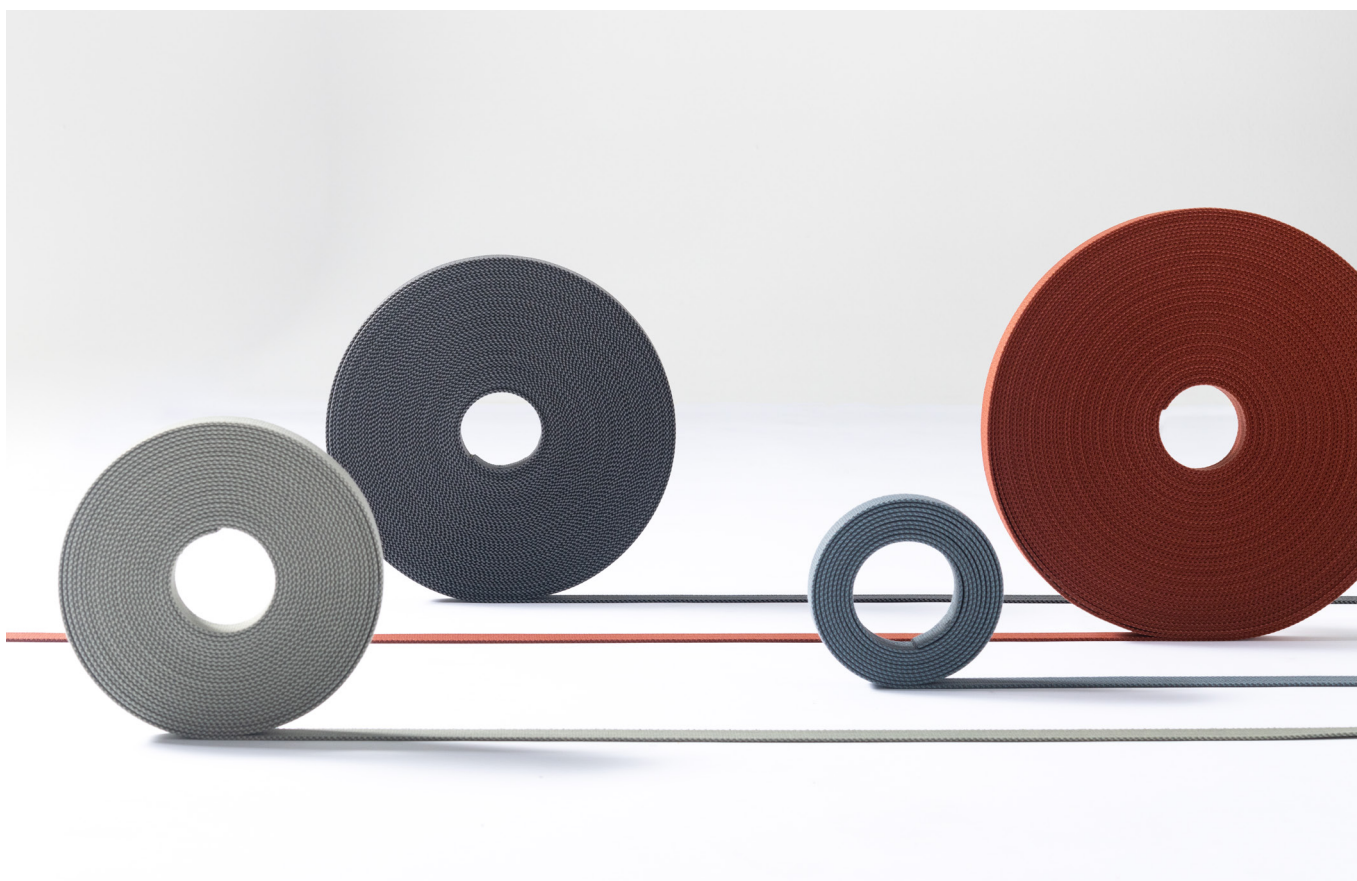

The distance of the belt from the wall or the ceiling, when installed in parallel, is always 4,5 cm.

Belt terminations

Belt terminations can be adjusted during the installation process according to your preference.

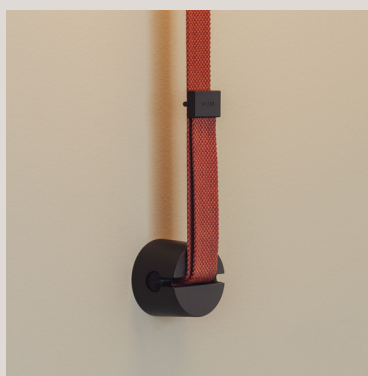
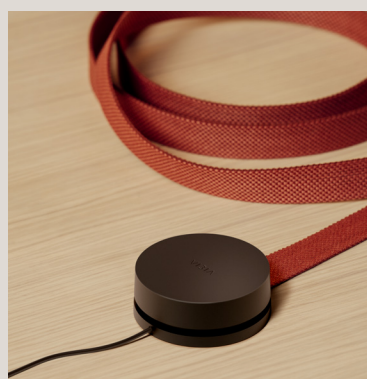
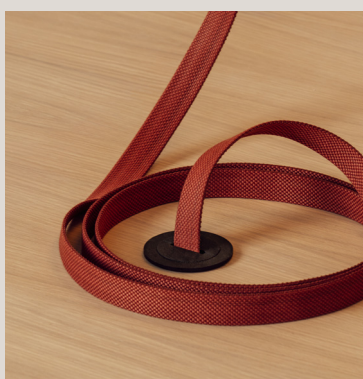
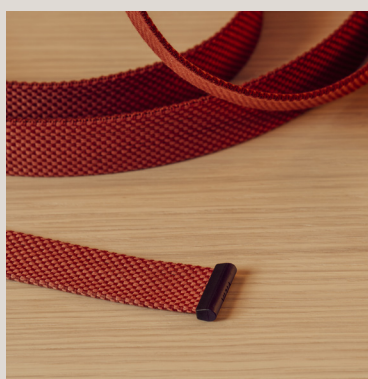

Composition examples for orientative prices

The final price of the composition depends on the number of luminaires, belt length, dimming control and the electrical connection type chosen.

Composition examples for orientative prices

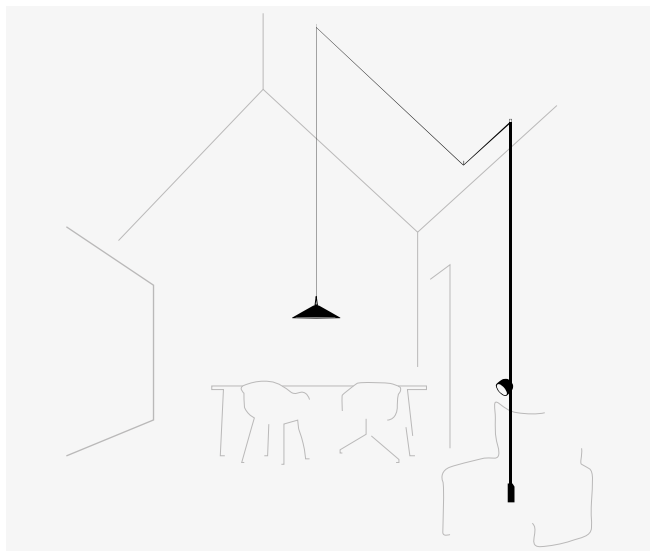

Sketch composed by one composition.
2 luminaires: Cone 6240, Spotlight 6215.

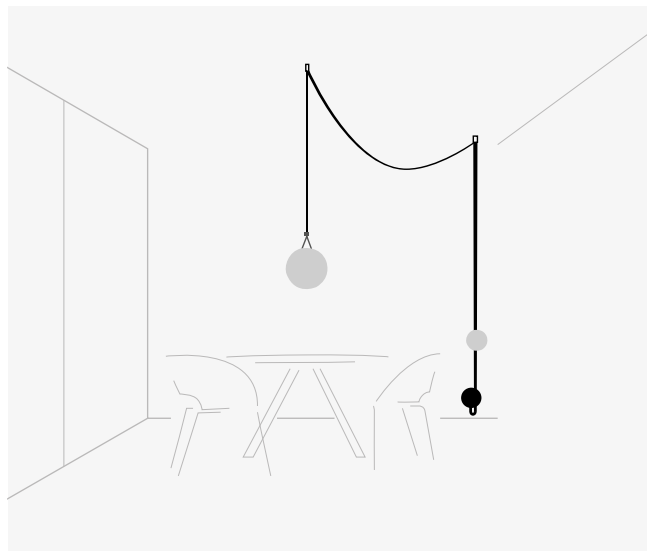

Sketch composed by one composition.
2 luminaires: Sphere 6230, Sphere 6235.

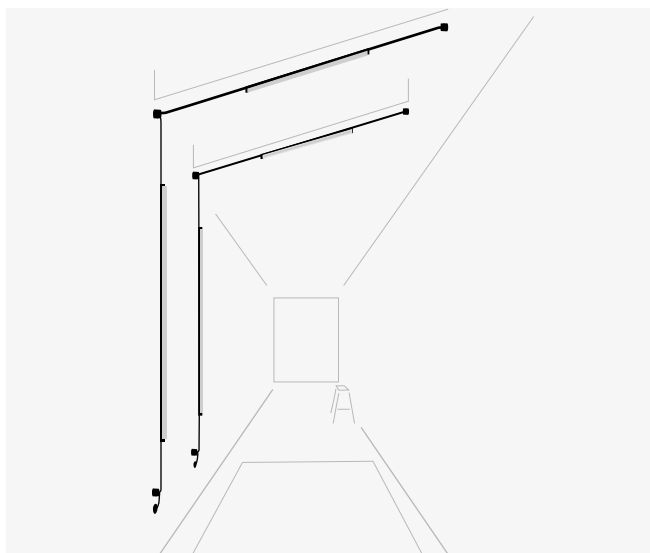

Sketch composed by two identical compositions.
2 luminaires: Linear Diffuser 6250, Linear Diffuser 6255.

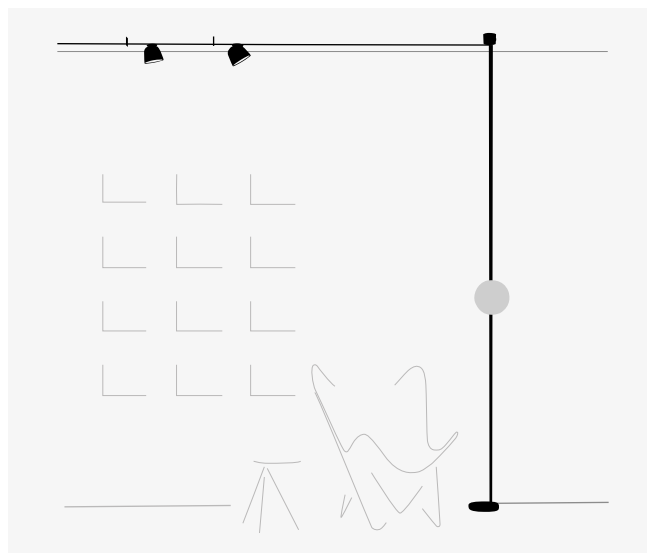

Sketch composed by one composition.
3 luminaires: Spotlight 6205 x 2, Sphere 6230.



Sketch composed by one composition.

1 luminaire: Sphere 6230.

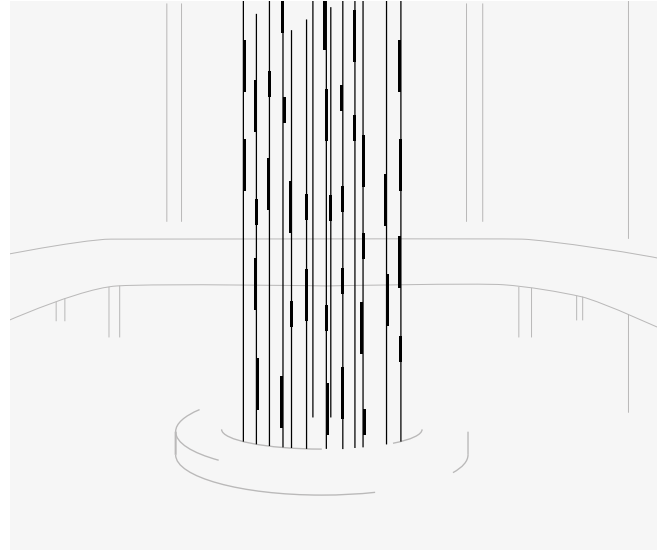

Sketch composed by several compositions.

3 luminaires: Linear Diffuser 6255.

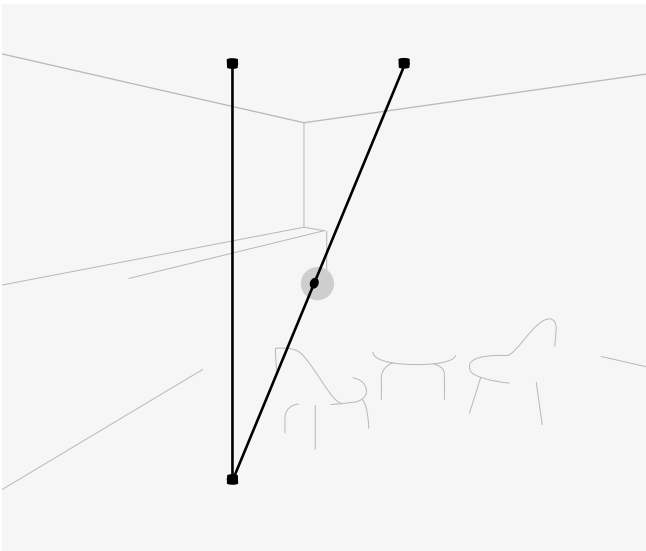

Sketch composed by one composition.

1 luminaire: Sphere 6230.

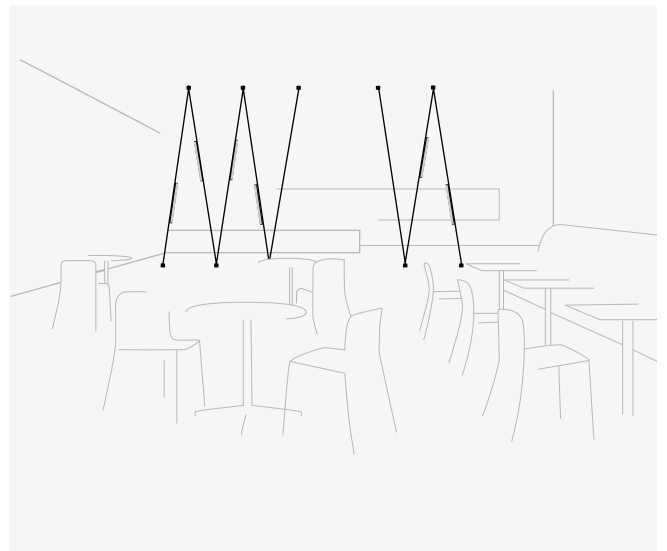

Sketch composed by two compositions.

2 luminaires: Linear Diffuser 6250.

Composition examples for orientative prices

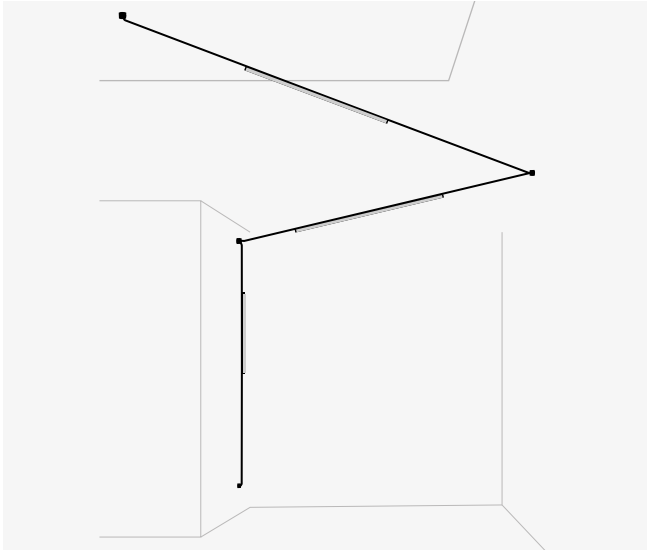

Sketch composed by one composition.

3 luminaires: Linear Diffuser 6250, Linear Diffuser 6255 x 2.

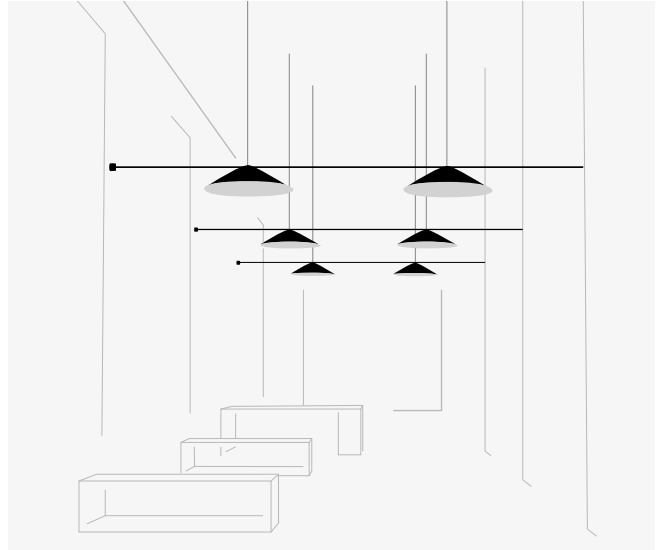

Sketch composed by three identical compositions.

2 luminaires: Cone 6245 x 2.

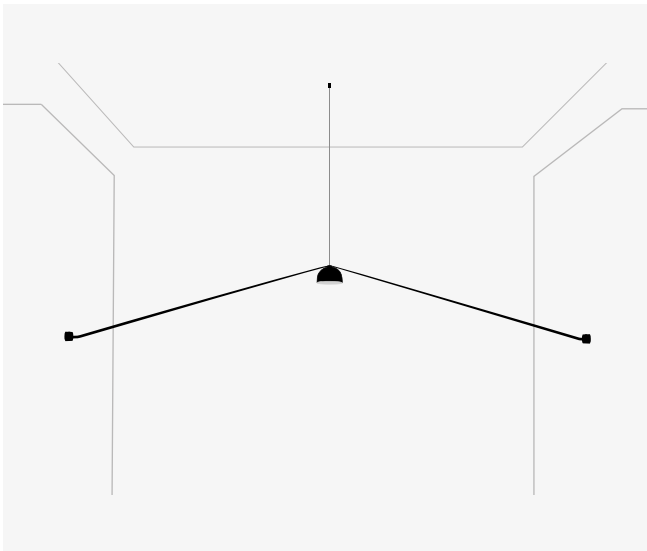

Sketch composed by one composition.

1 luminaire: Semisphere 6225.

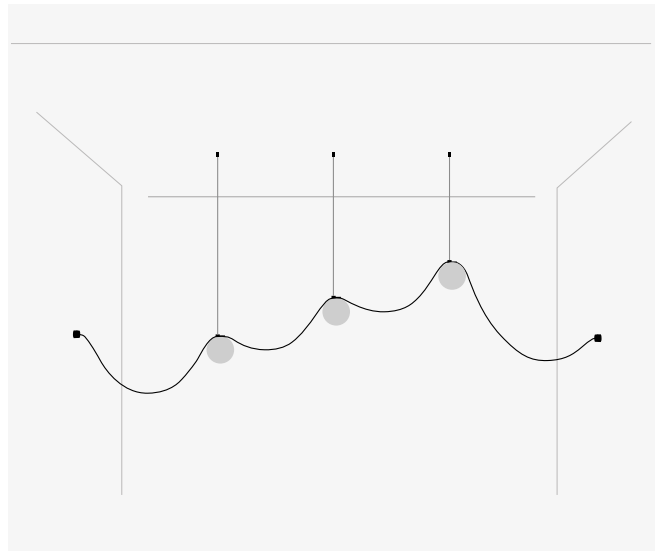

Sketch composed by one composition.

3 luminaires: Sphere 6230 x 3.

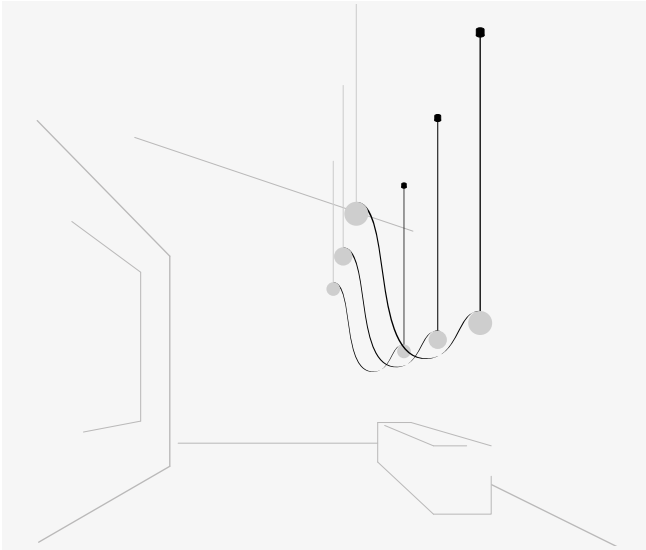

Sketch composed by three identical compositions.

2 luminaires: Sphere 6235 x 2.

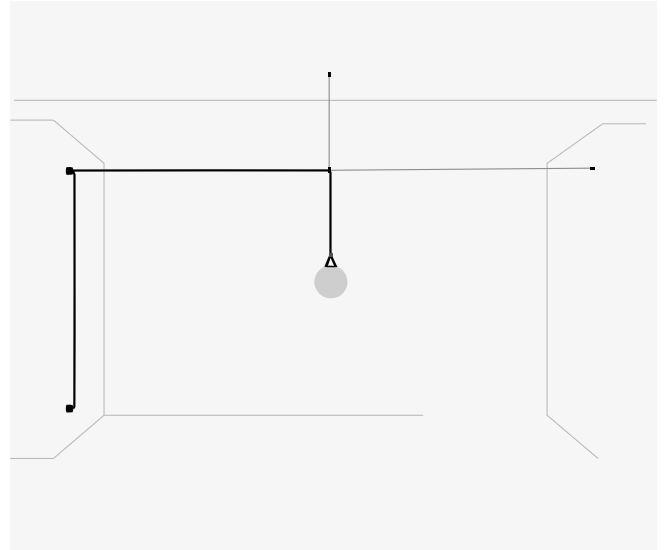

Sketch composed by one composition.

1 luminaire: Sphere 6235.

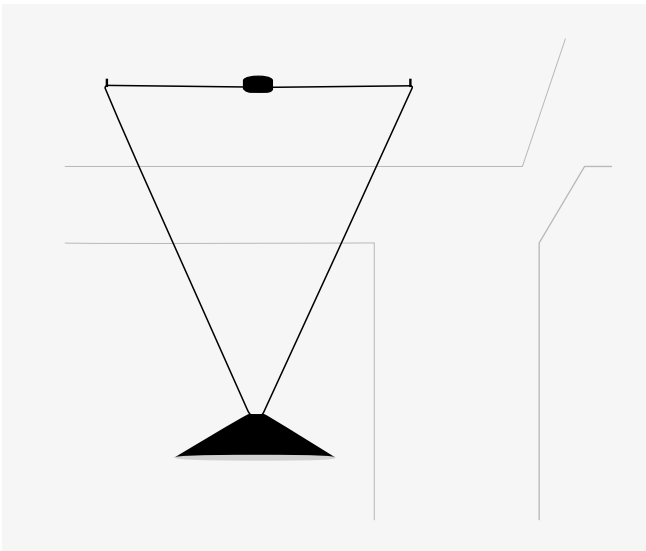

Sketch composed by one composition.

1 luminaire: Cone 6245.

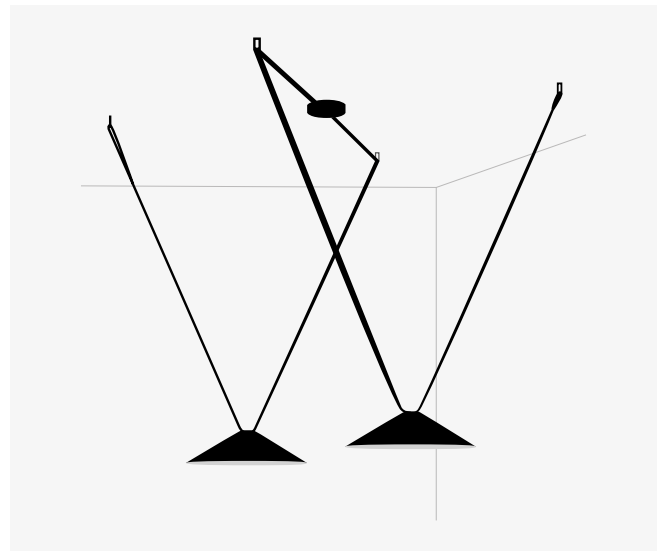

Sketch composed by one composition.

2 luminaires: Cone 6240 x 2.

Composition examples for orientative prices

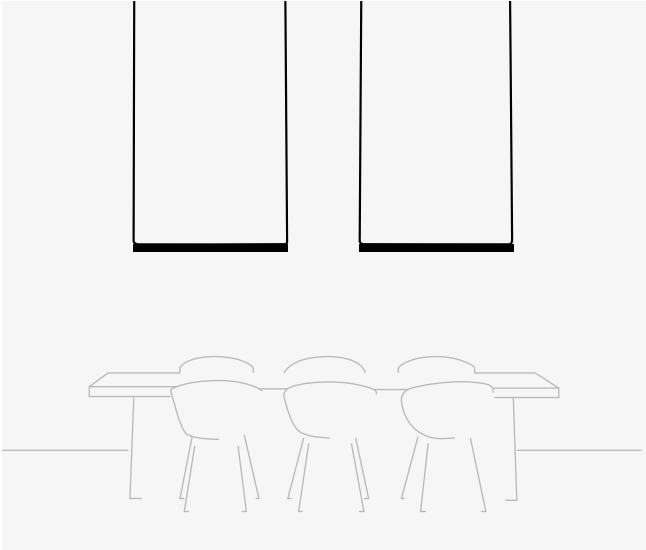

Sketch composed by one composition.

2 luminaires: Linear Low UGR High-Comfort 6270 x 2.



Sketch composed by one composition.

5 luminaires: Sphere 6230 x 5.

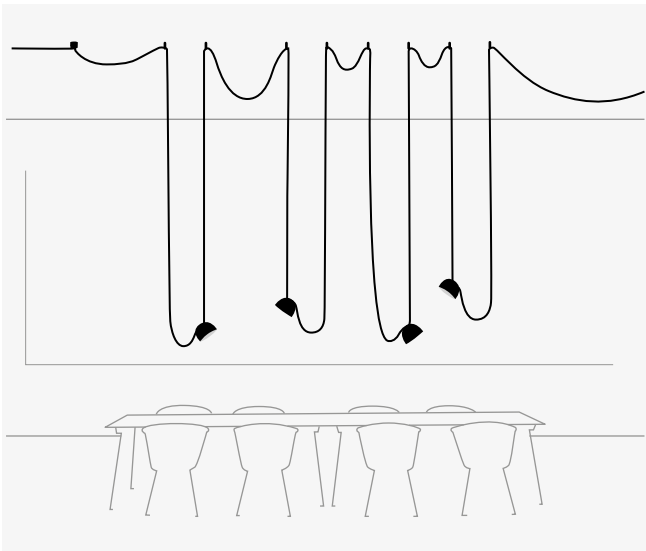

Sketch composed by one composition.

4 luminaires: Semisphere 6220 x 4.

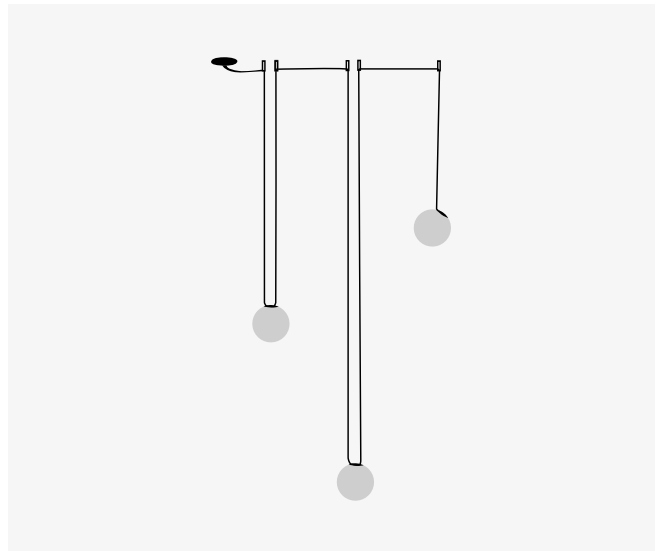

Sketch composed by one composition.

3 luminaires: Sphere 6230 x 3.

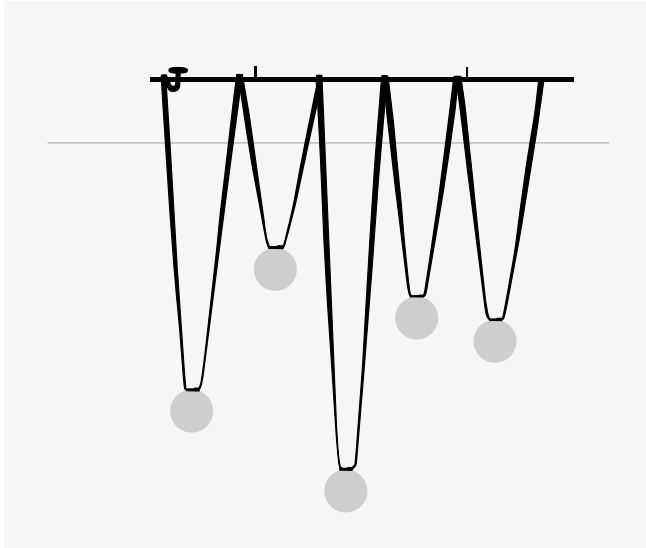

Sketch composed by one composition.

5 luminaires: Sphere 6230 x 5.

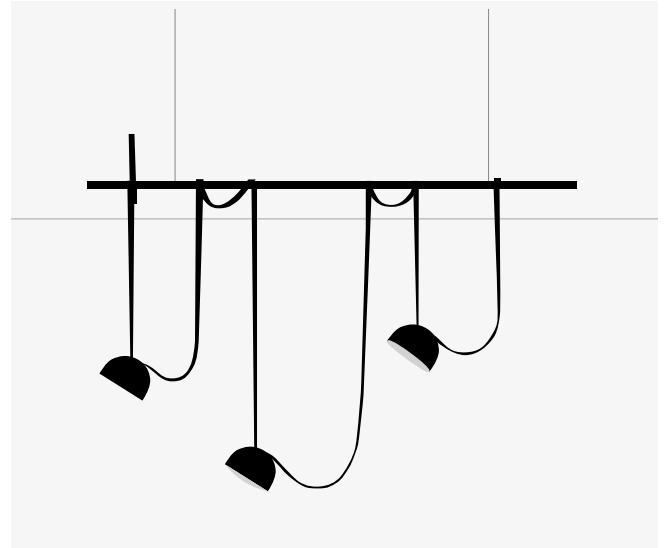

Sketch composed by one composition.

3 luminaires: Semisphere 6220 x 3.

Each project is unique.
Visit vibia.com and chose among
multiple compositions designed
and adapted to your project needs.

Personalise your own Plusminus composition
quick and easy at vibia.com

Kontur

Design by Sebastian Herkner

Providing a framework for light, the Kontur collection serves as an elegant stage setting for the linear light source it contains. Its minimalist black frame pairs with different diffusers or reflectors in a poetic balance, creating myriad lighting ambiances.

Wall



20 x 92 cm

6414

20 x 122 cm

6416

20 x 162 cm

6418

19 x 92 cm

6444

19 x 122 cm

6446

6414

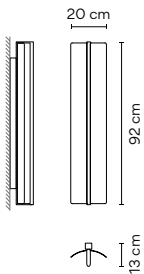

Finishes

- 11/ __ Black (NCS S 8500-N)

LED temperature colour

- /7 _ 2200 K CRI >90 2041,15 lm 97,2 lm/W
- /1 _ 2700 K CRI >90 2381,3 lm 113 lm/W
- /2 _ 3000 K CRI >90 2381,3 lm 113 lm/W

Control

- 6414 __ / _ 1 DALI
- 6414 __ / _ 3 1-10V
- 6414 __ / _ 5 Push
- 6414 __ / _ Z Casambi

Materials

Concave shade: Aluminum. Diffuser: Polycarbonate. Structures: Steel. Canopy: Aluminum.

Light Source and electronics

1 x LED STRIP 20,8 W 750 mA
Constant Current 750 mA
90-305V 50/60Hz

Packaging

1 Box 0,30 x 0,30 x 1,05 m
Vol 0,095 m³
Gross weight 5,5 Kg Net weight 3,5 Kg

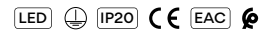

6416

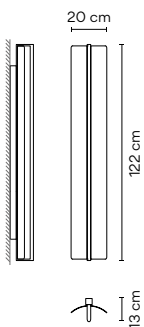

Finishes

- 11/ __ Black (NCS S 8500-N)

LED temperature colour

- /7 _ 2200 K CRI >90 2703,32 lm 96,9 lm/W
- /1 _ 2700 K CRI >90 3153,9 lm 113 lm/W
- /2 _ 3000 K CRI >90 3153,0 lm 113 lm/W

Control

- 6416 __ / _ 1 DALI
- 6416 __ / _ 3 1-10V
- 6416 __ / _ 5 Push
- 6416 __ / _ Z Casambi

Materials

Concave shade: Aluminum. Diffuser: Polycarbonate. Structures: Steel. Canopy: Aluminum.

Light Source and electronics

1 x LED STRIP 27,9 W 750 mA
Constant Current 750 mA
90-305V 50/60Hz

Packaging

1 Box 0,30 x 0,30 x 1,35 m
Vol 0,122 m³
Gross weight 5,8 Kg Net weight 3,8 Kg

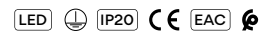

6418

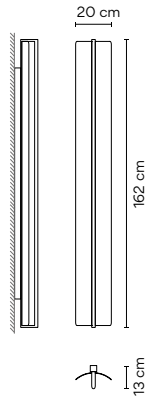

Finishes
 ● 11/ _ _ Black
 (NCS S 8500-N)

LED temperature colour
 /7 _ 2200 K **F** →
 CRI >90 3604,42 lm 96,9 lm/W
 /1 _ 2700 K **E** →
 CRI >90 4205,2 lm 113 lm/W
 /2 _ 3000 K **F** →
 CRI >90 4205,2 lm 113 lm/W

Control
 6418 _ _ / _ 1
 DALI

6418 _ _ / _ 3
 1-10V

6418 _ _ / _ 5
 Push

6418 _ _ / _ Z
 Casambi

Materials

Concave shade: Aluminum. Diffuser: Polycarbonate.
 Structures: Steel. Canopy: Aluminum.

Light Source and electronics

1 x LED STRIP 37,2 W 750 mA
 Constant Current 750 mA
 90-305V 50/60Hz

Packaging

1 Box 0,30 x 0,30 x 0,175 m
 Vol 0,1580 m³
 Gross weight 6,5 Kg Net weight 4 Kg

LED IP20 CE EAC

Dimmer Multi-volt

6444

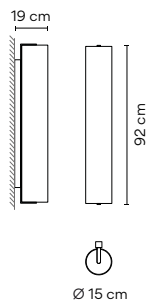

Finishes
 ● 11/ _ _ Black
 (NCS S 8500-N)

LED temperature colour
 /7 _ 2200 K **F** →
 CRI >90 2041,15 lm 98,1 lm/W
 /1 _ 2700 K **E** →
 CRI >90 2381,3 lm 114 lm/W
 /2 _ 3000 K **F** →
 CRI >90 2381,3 lm 114 lm/W
 /3 _ 3500 K **E** →
 CRI >90 2551,44 lm 122,7 lm/W

Control
 6444 _ _ / _ 1
 DALI

6444 _ _ / _ 3
 1-10V

6444 _ _ / _ 5
 Push

6444 _ _ / _ Z
 Casambi

Materials

Glass shade: Opal triplex Diffuser: Polycarbonate.
 Structures: Steel. Canopy: Aluminum.

Light Source and electronics

1 x LED STRIP 20,8 W 750 mA
 Constant Current 750 mA
 90-305V 50/60Hz

Packaging

1 Box 0,30 x 0,30 x 1,05 m
 Vol 0,095 m³
 Gross weight 6,2 Kg Net weight 3,7 Kg

LED IP20 CE EAC

Dimmer Multi-volt

6446

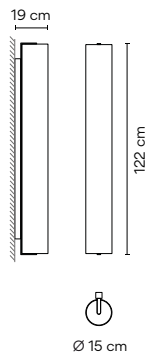

Finishes
 ● 11/ _ _ Black
 (NCS S 8500-N)

LED temperature colour
 /7 _ 2200 K **F** →
 CRI >90 2703,32 lm 96,9 lm/W
 /1 _ 2700 K **E** →
 CRI >90 3153,9 lm 113 lm/W
 /2 _ 3000 K **F** →
 CRI >90 3153,0 lm 113 lm/W
 /3 _ 3500 K **E** →
 CRI >90 3379,15 lm 121,1 lm/W

Control
 6446 _ _ / _ 1
 DALI

6446 _ _ / _ 3
 1-10V

6446 _ _ / _ 5
 Push

6446 _ _ / _ Z
 Casambi

Materials

Glass shade: Opal triplex Diffuser: Polycarbonate.
 Structures: Steel. Canopy: Aluminum.

Light Source and electronics

1 x LED STRIP 27,9 W 750 mA
 Constant Current 750 mA
 90-305V 50/60Hz

Packaging

1 Box 0,30 x 0,30 x 1,35 m
 Vol 0,122 m³
 Gross weight 9 Kg Net weight 6 Kg

LED IP20 CE EAC

Dimmer Multi-volt

Pendants

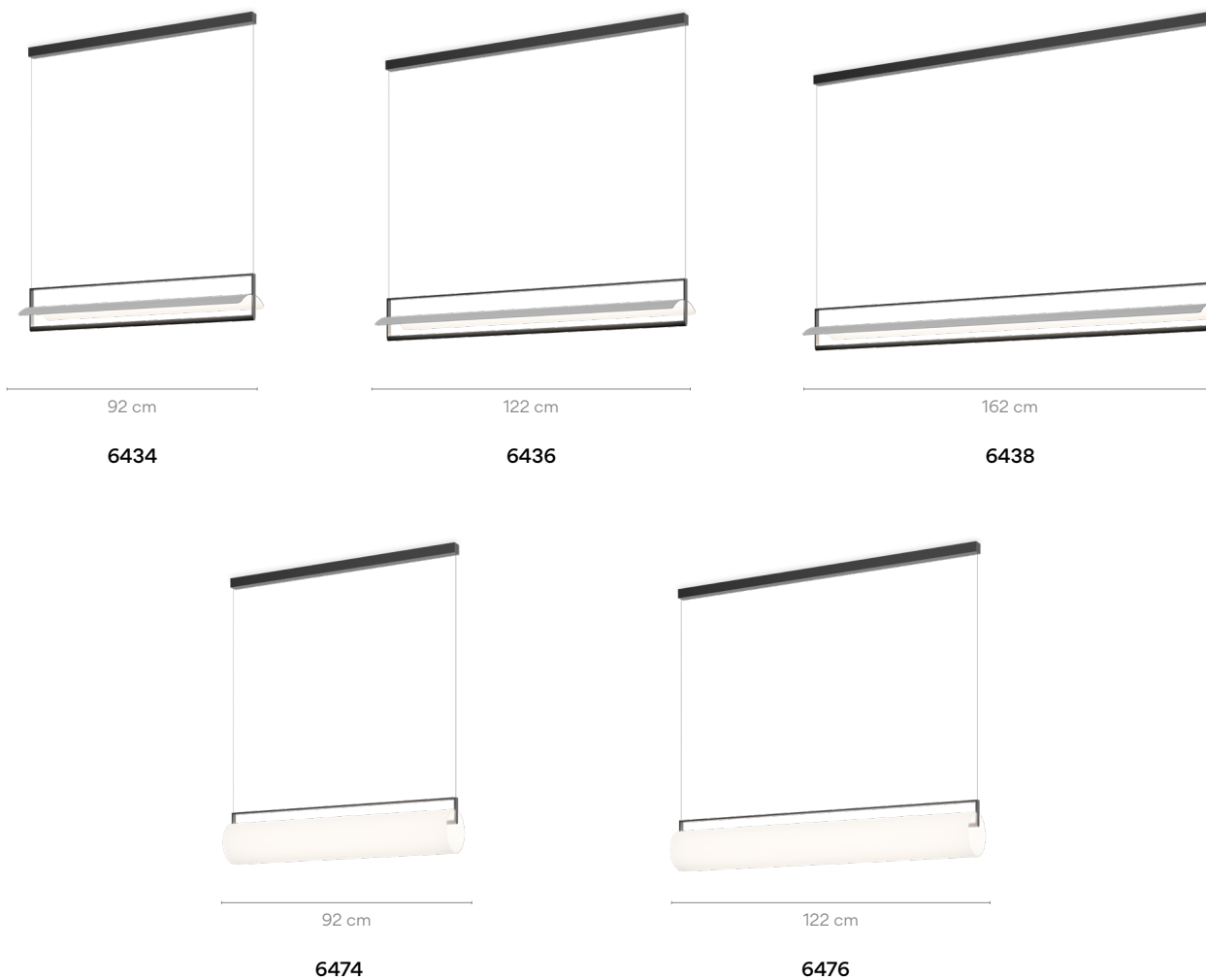

6434

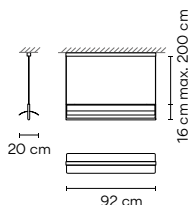

<p>Finishes</p> <ul style="list-style-type: none"> ● 11/ _ _ Black (NCS S 8500-N) 	<p>LED temperature colour</p> <ul style="list-style-type: none"> /7 _ 2200 K E CRI >90 2041,15 lm 98,1 lm/W /1 _ 2700 K E CRI >90 2381,3 lm 114 lm/W /2 _ 3000 K F CRI >90 2381,3 lm 114 lm/W /3 _ 3500 K E CRI >90 2551,44 lm 122,7 lm/W 	<p>Control</p> <ul style="list-style-type: none"> 6434 _ _ / _ 1 DALI 6434 _ _ / _ 3 1-10V 6434 _ _ / _ 5 Push 6434 _ _ / _ Z Casambi
<p>Materials</p> <p>Concave shade: Aluminum. Diffuser: Polycarbonate. Structures: Steel. Canopy: Aluminum.</p> <p>Light Source and electronics</p> <p>1 x LED STRIP 20,8 W 750 mA Constant Current 750 mA 90-305V 50/60Hz</p>	<p>Packaging</p> <p>1 Box 0,30 x 0,30 x 1,05 m Vol 0,095 m³ Gross weight 5,5 Kg Net weight 3,5 Kg</p> <p>Notes</p> <p>Extra cable length.</p>	<p>LED Ⓡ IP20 CE EAC Ⓡ</p> <p>Dimmer Multi-volt</p>

6436

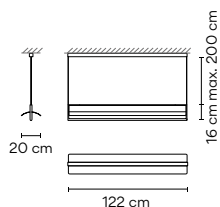

Finishes
 ● 11/ __ Black
 (NCS S 8500-N)

LED temperature colour
 /7 _ 2200 K **F**
 CRI >90 2703,32 lm 96,9 lm/W
 /1 _ 2700 K **E**
 CRI >90 3153,9 lm 113 lm/W
 /2 _ 3000 K **F**
 CRI >90 3154,0 lm 113 lm/W
 /3 _ 3500 K **E**
 CRI >90 3379,15 lm 121,1 lm/W

Control

6436 __ / _ 1

DALI

6436 __ / _ 3

1-10V

6436 __ / _ 5

Push

6436 __ / _ Z

Casambi

Materials

Concave shade: Aluminum. Diffuser: Polycarbonate.
 Structures: Steel. Canopy: Aluminum.

Light Source and electronics

1 x LED STRIP 27,9 W 750 mA
 Constant Current 750 mA
 90~305V 50/60Hz

Packaging

1 Box 0,30 x 0,30 x 1,35 m
 Vol 0,122 m³
 Gross weight 5,8 Kg Net weight 3,8 Kg

Notes

Extra cable length.



6438

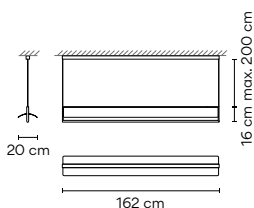

Finishes
 11/ __ Black
 (NCS S 8500-N)

LED temperature colour
 /7 _ 2200 K **F**
 CRI >90 3604,42 lm 96,9 lm/W
 /1 _ 2700 K **E**
 CRI >90 4205,2 lm 113 lm/W
 /2 _ 3000 K **F**
 CRI >90 4205,2 lm 113 lm/W
 /3 _ 3500 K **E**
 CRI >90 4505,53 lm 121,1 lm/W

Control

6438 __ / _ 1

DALI

6438 __ / _ 3

1-10V

6438 __ / _ 5

Push

6438 __ / _ Z

Casambi

Materials

Concave shade: Aluminum. Diffuser: Polycarbonate.
 Structures: Steel. Canopy: Aluminum.

Light Source and electronics

1 x LED STRIP 37,2 W 750 mA
 Constant Current 750 mA
 90~305V 50/60Hz

Packaging

1 Box 0,30 x 0,30 x 1,75 m
 Vol 0,158 m³
 Gross weight 6,5 Kg Net weight 4 Kg

Notes

Extra cable length.



6474

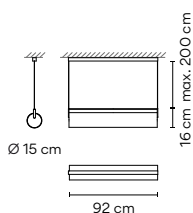

Finishes
 ● 11/ __ Black
 (NCS S 8500-N)

LED temperature colour
 /7 _ 2200 K **F**
 CRI >90 2041,15 lm 98,1 lm/W
 /1 _ 2700 K **E**
 CRI >90 2381,3 lm 114 lm/W
 /2 _ 3000 K **F**
 CRI >90 2381,3 lm 114 lm/W

Control

6474 __ / _ 1

DALI

6474 __ / _ 3

1-10V

6474 __ / _ 5

Push

6474 __ / _ Z

Casambi

Materials

Glass shade: Opal triplex. Diffuser: Polycarbonate.
 Structures: Steel. Canopy: Aluminum.

Light Source and electronics

1 x LED STRIP 20,8 W 750 mA
 Constant Current 750 mA
 90~305V 50/60Hz

Packaging

1 Box 0,30 x 0,30 x 1,05 m
 Vol 0,095 m³
 Gross weight 6,2 Kg Net weight 3,7 Kg

Notes

Extra cable length.



6476

Finishes
 ● 11/ _ _ Black
 (NCS S 8500-N)

LED temperature colour
 /7 2200 K **F**
 CRI >90 2703,32 lm 96,9 lm/W
 /1 2700 K **E**
 CRI >90 3153,9 lm 113 lm/W
 /2 3000 K **F**
 CRI >90 3153,0 lm 113 lm/W

Control
 6476 _ _ / _ 1
 DALI
 6476 _ _ / _ 3
 1-10V
 6476 _ _ / _ 5
 Push
 6476 _ _ / _ Z
 Casambi

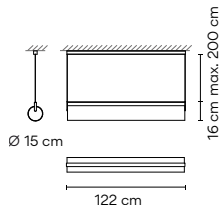

Materials
 Glass shade: Opal triplex. Diffuser: Polycarbonate.
 Structures: Steel. Canopy: Aluminum.

Light Source and electronics
 1 x LED STRIP 27,9 W 750 mA
 Constant Current 750 mA
 90-305V 50/60Hz

Packaging
 1 Box 0,75 x 0,45 x 1,35 m
 Vol 0,122 m³
 Gross weight 9 Kg Net weight 6 Kg

Notes
 Extra cable length.

LED IP20 CE EAC
 Dimmer Multi-volt

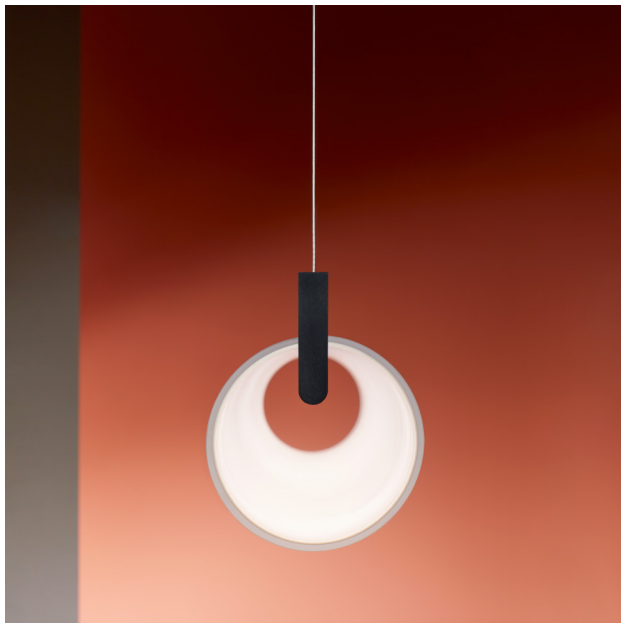



Sticks Connectable

Design by Arik Levy

Fusing technology, space, and architecture, Sticks offers a creative toolkit for integrating light elements in an interior. Pure and graphic, the minimalist aluminum rods transform linear light into floating sculpture.



You can choose the desired composition through one of the following three options:

A - Choose among pre-designed layouts the one that fits with your project and order it directly (see page 366).

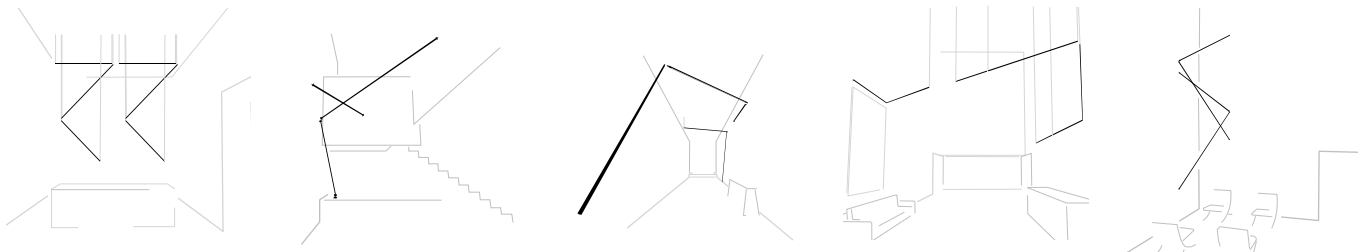

B - Select one composition on vibia.com among multiple applications in spaces, and adjust it to your project by modifying:

- + Length of the sticks.
- + Position of each stick in the space.
- + Colour temperature and dimming.
- + Installation type.

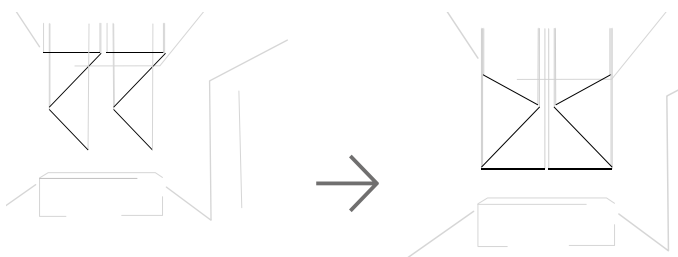

C - Create your configuration on vibia.com from scratch in three easy steps, without sketches.

1

Choose the location for your electrical connection point



2

Add connectable Sticks up to 6.5 meters



3

Configure
+ Colour temperature
+ Dimming control
+ Installation type
+ Pendants height



Technical Specifications

(see page 374)

The Sticks collection has three sizes: 1.5 m, 2 m, or 3 m, and they can be connected one to each other to a total maximum length of 6.5 meters per electrical connection.

Wall-Wall / Ceiling-Ceiling

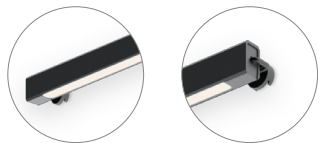

Wall-Wall (corner) / Wall-Ceiling

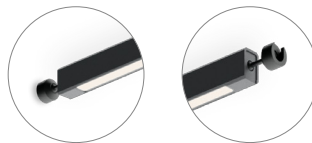

Wall-Pendants

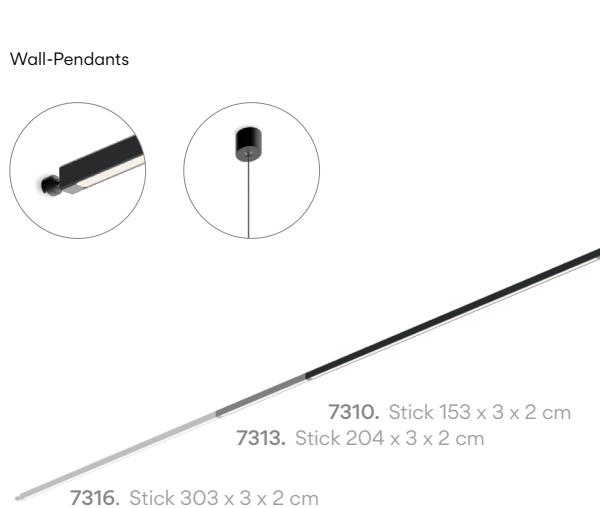
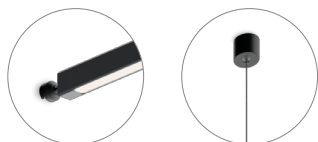

Pendants-Pendants

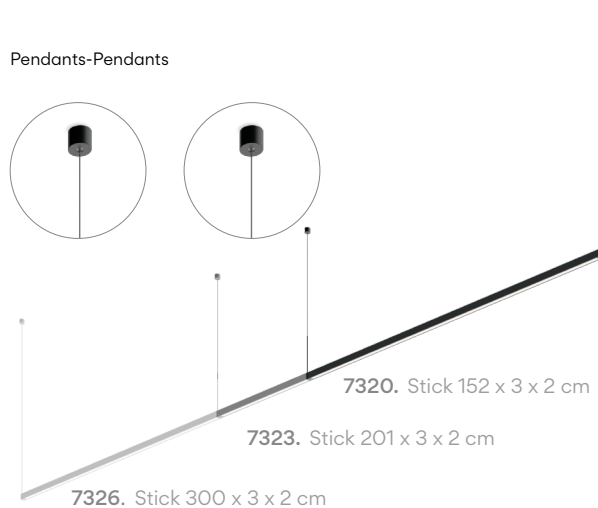
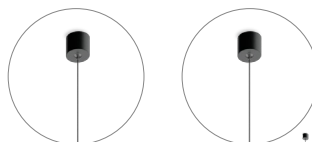

Pendants



Floor-Wall

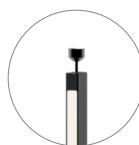

Sticks Connectable

Next sketches are composed by one or more compositions

Pendant / Ceiling

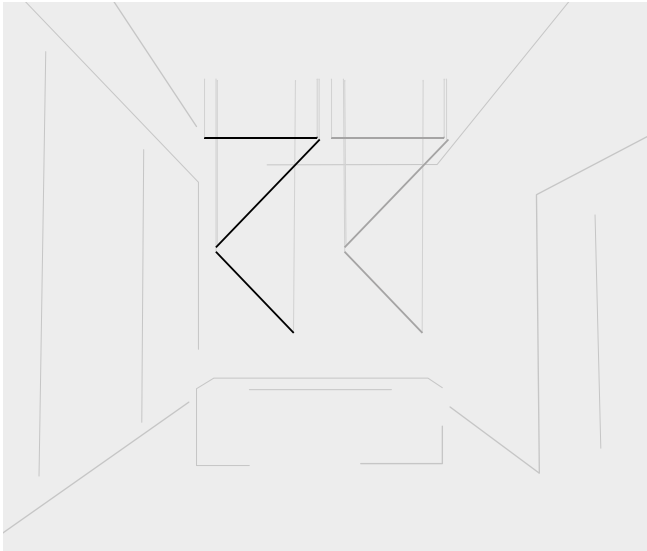

ST1001
Sketch composed by two identical compositions.

Each composition:
3 Sticks: 2 x 150 cm, 1 x 200 cm. Total 5 m.
LED 4000 K. 11870 lm. 88 W.
Remote driver Built-in Micro. 1-10V.

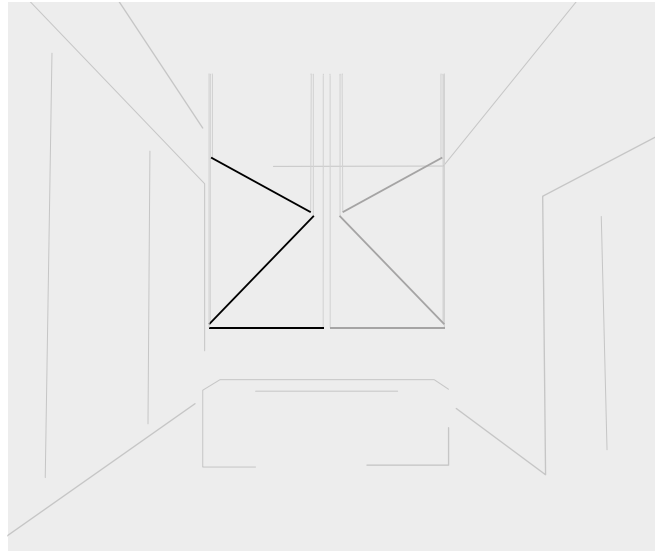

ST1005
Sketch composed by two identical compositions.

Each composition:
3 Sticks: 2 x 150 cm, 1 x 200 cm. Total 5 m.
LED 4000 K. 11870 lm. 88 W.
Remote driver Built-in Micro. 1-10V.

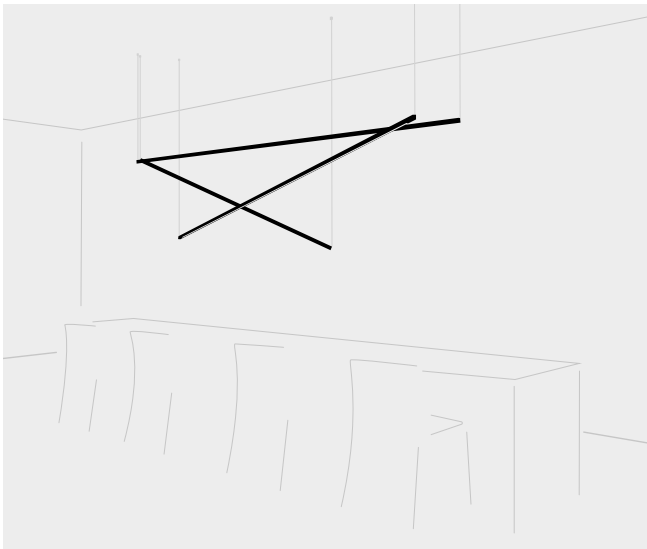

ST1015
Sketch composed by two compositions.

Composition 1:
2 Sticks: 1 x 150 cm, 1 x 300 cm. Total 4,5 m.
LED 2700 K. 9779 lm. 79,2 W.
Built-in disc S canopy. 1-10V.

Composition 2:
1 Stick: 1 x 300 cm. Total 3 m.
LED 2700 K. 6519 lm. 52,8 W.
Built-in disc S canopy. 1-10V.

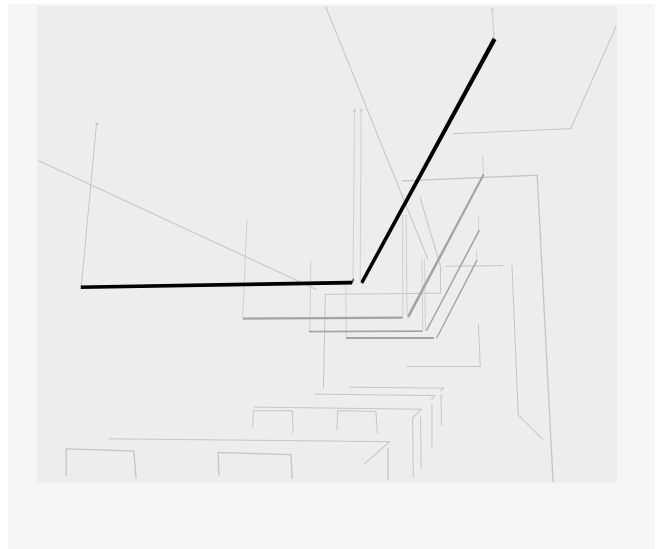

ST1021
Sketch composed by four identical compositions.

Each composition:
2 Sticks: 2 x 200 cm. Total 4 m.
LED 4000 K. 9496 lm. 140,8 W.
Built-in disc S canopy. 1-10V.

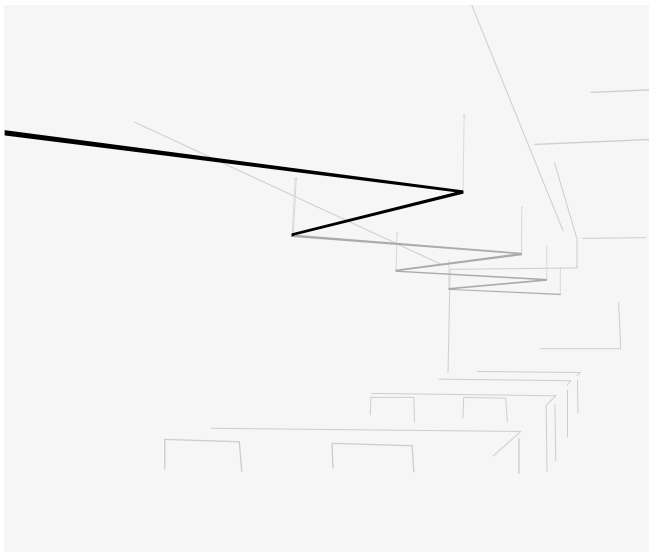

ST1025

Sketch composed by four identical compositions.

Each composition:

2 Sticks: 2 x 300 cm. Total 6 m.
LED 4000 K. 14244 lm. 105,6 W.
Built-in disc S canopy. 1-10V.

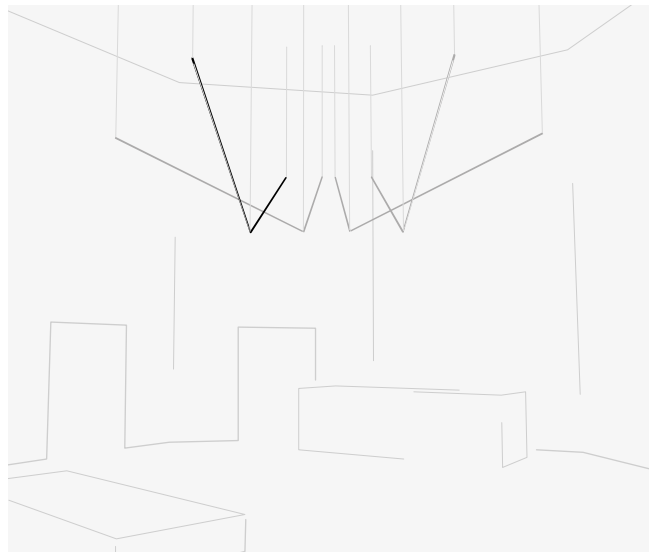

ST1035

Sketch composed by four identical compositions.

Each composition:

2 Sticks: 1 x 300 cm, 1 x 150 cm. Total 4,5 m.
LED 4000 K. 10683 lm. 79,2 W.
Built-in disc S canopy. 1-10V.

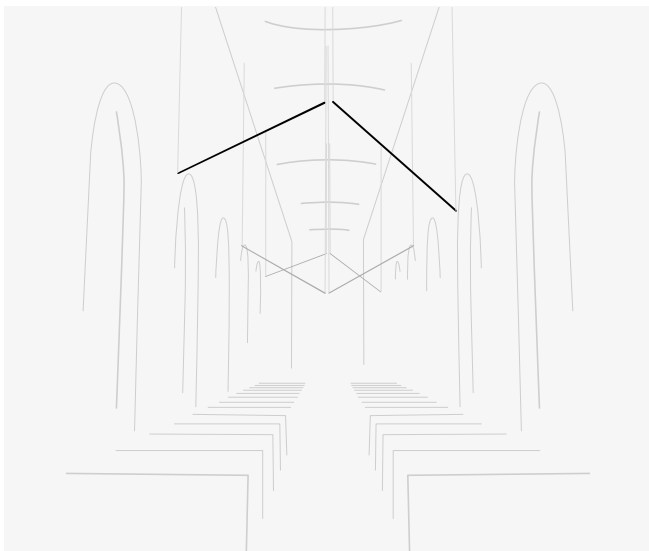

ST1041

Sketch composed by three identical compositions.

Each composition:

2 Sticks: 2 x 300 cm. Total 6 m.
LED 4000 K. 14244 lm. 105,6 W.
Built-in disc S canopy. 1-10V.

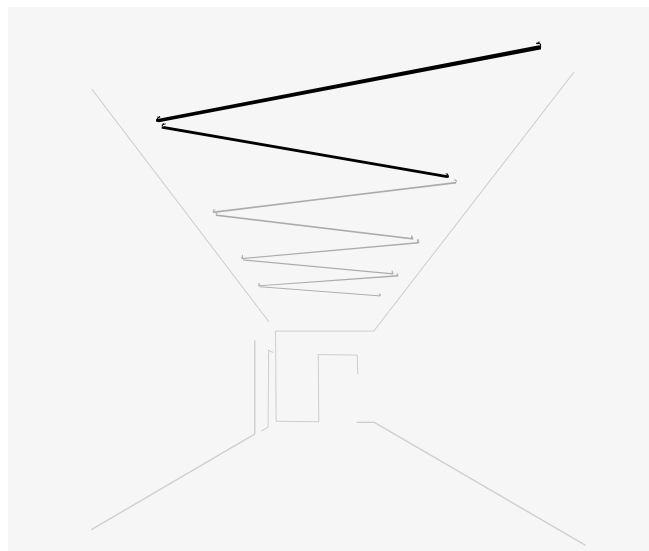

ST1085

Sketch composed by four identical compositions.

Each composition:

2 Sticks: 2 x 300 cm. Total 6 m.
LED 4000 K. 14244 lm. 105,6 W.
Remote driver Built-in Micro. 1-10V.

Sticks Connectable

Next sketches are composed by one or more compositions

Some sticks are attached to the Wall

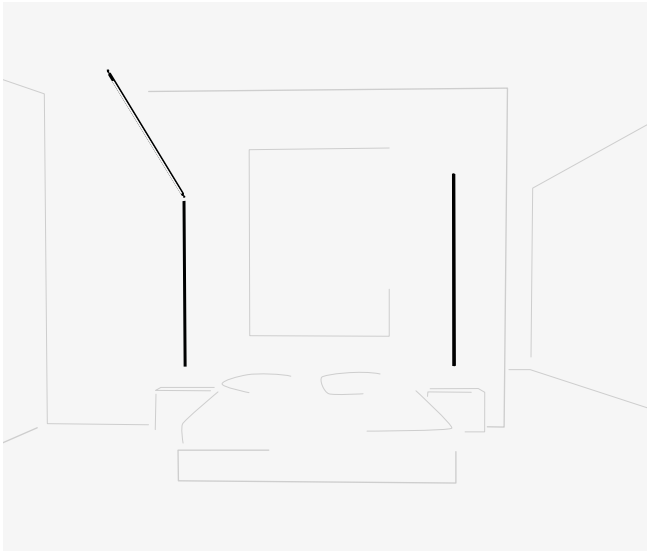

STI051
Sketch composed by two compositions.

Composition 1:
2 Sticks: 2 x 150 cm. Total 3 m.
LED 2700 K. 6520 lm. 52,8 W.
Floor base & plug. Push.

Composition 2:
1 Stick: 1 x 200 cm. Total 2 m.
LED 2700 K. 4346 lm. 35,2 W.
Floor base & plug. Push.

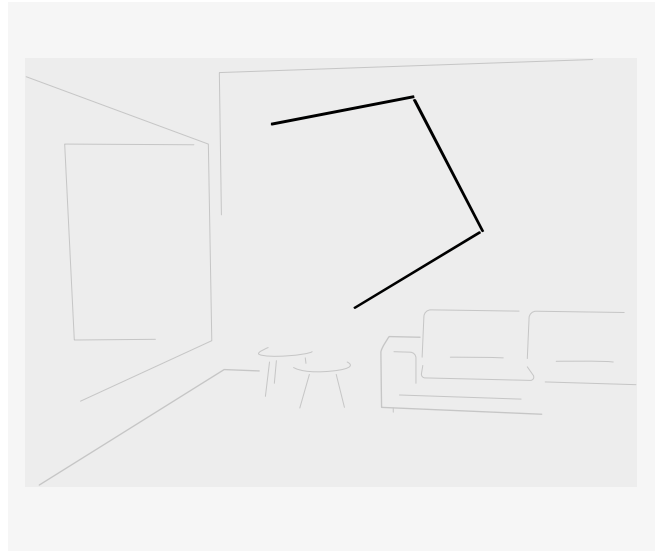

STI055
Sketch composed by only one composition.

3 Sticks: 3 x 150 cm. Total 4,5 m.
LED 2700 K. 9780 lm. 79,2 W.
Floor base & plug. Push.

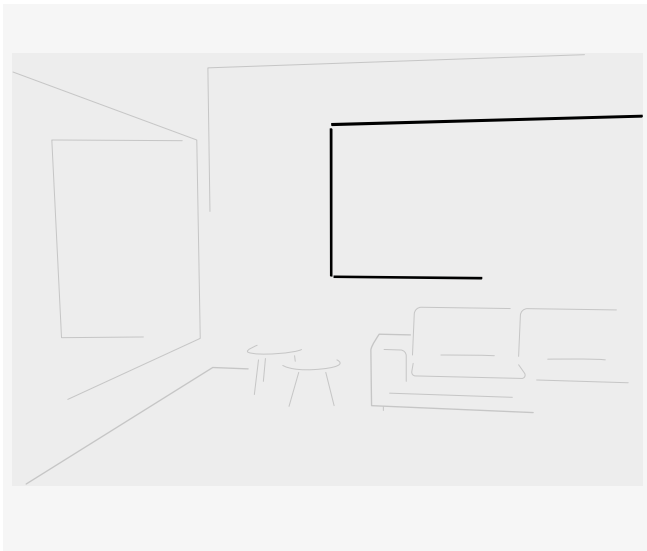

STI061
Sketch composed by only one composition.

3 Sticks: 2 x 150 cm, 1 x 300 cm. Total 6 m.
LED 2700 K. 13039 lm. 105,6 W.
Floor base & plug. Push.

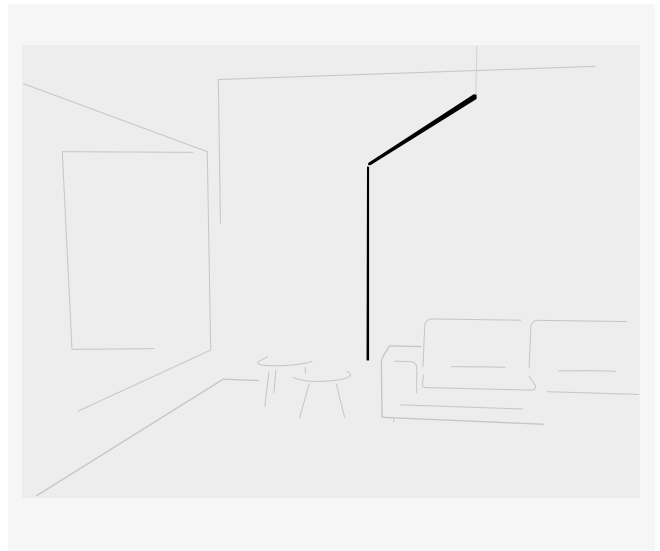

STI065
Sketch composed by only one composition.

2 Sticks: 2 x 150 cm. Total 3 m.
LED 2700 K. 6520 lm. 52,8 W.
Floor base & plug. Push.

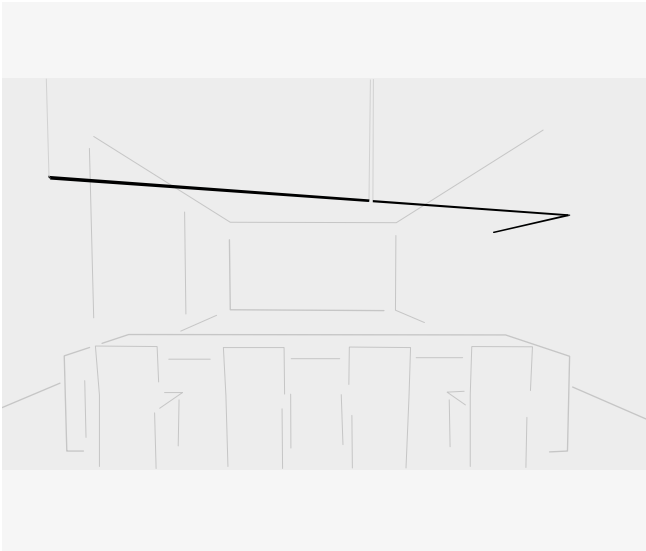

ST1071

Sketch composed by only one composition.

3 Sticks: 1 x 150 cm, 2 x 200 cm. Total 5,5 m.
 LED 2700 K. 11952 lm. 96,8 W.
 Floor base & plug. Push.

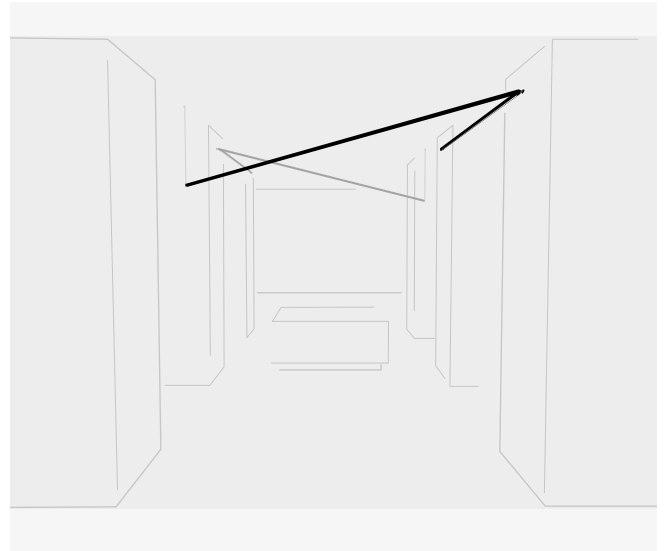

ST1075

Sketch composed by two identical compositions.

Each composition:
 2 Sticks: 2 x 300 cm. Total 6 m.
 LED 4000 K. 14244 lm. 105,6 W.
 Remote driver Built-in Micro. 1-10V.

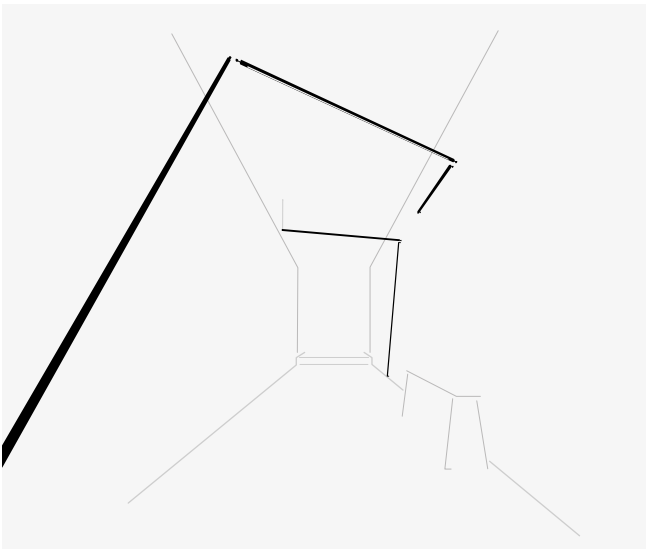

ST1081

Sketch composed by two compositions.

Composition 1:
 3 Sticks: 1 x 150 cm, 1 x 200 cm, 1 x 300 cm. Total 6,5 m.
 LED 4000 K. 15431 lm. 114,4 W.
 Remote driver Built-in Micro. 1-10V.

Composition 2:
 2 Sticks: 1 x 300 cm, 1 x 200 cm. Total 5 m.
 LED 4000 K. 11870 lm. 88 W.
 Remote driver Built-in Micro. 1-10V.

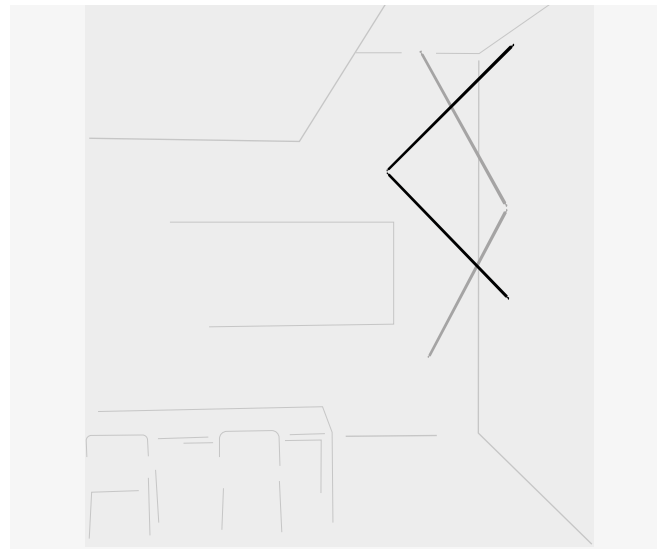

ST1091

Sketch composed by two identical compositions.

Each composition:
 2 Sticks: 2 x 200 cm. Total 4 m.
 LED 2700 K. 8692 lm. 70,4 W.
 Remote driver Built-in Micro. 1-10V.

Sticks Connectable

Next sketches are composed by one or more compositions

Some sticks are attached to the Wall



ST1095

Sketch composed by two identical compositions.

Each composition:

2 Sticks: 1 x 200 cm, 1 x 300 cm. Total 5 m.

LED 4000 K. 11870 lm. 88 W.

Remote driver Built-in Micro. 1-10V.

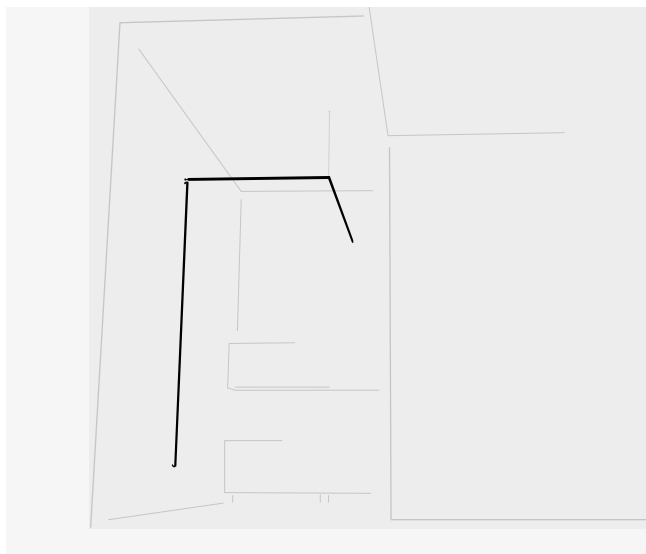

ST1101

Sketch composed by two compositions.

Composition 1:

2 Sticks: 1 x 300 cm, 1 x 150 cm. Total 4,5 m.

LED 2700 K. 9779 lm. 79,2 W.

Remote driver Built-in Micro. 1-10V.

Composition 2:

1 Stick: 1 x 300 cm. Total 3 m.

LED 2700 K. 6519 lm. 52,8 W.

Remote driver Built-in Micro. 1-10V.

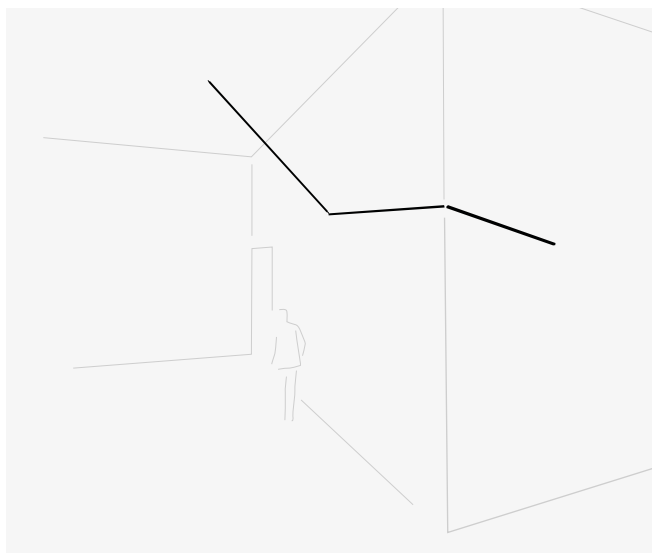

ST1105

Sketch composed by only one composition.

3 Sticks: 2 x 150 cm, 1 x 200 cm. Total 5 m.

LED 4000 K. 11870 lm. 88 W.

Floor base & plug. Push.

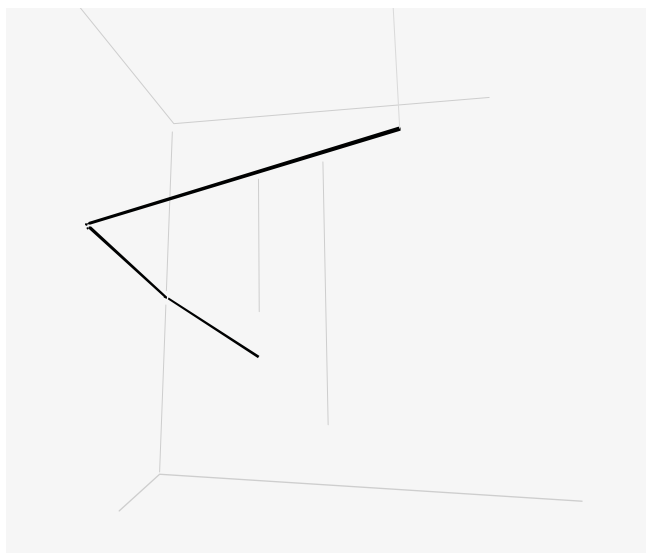

ST1111

Sketch composed by only one composition.

3 Sticks: 2 x 150 cm, 1 x 300 cm. Total 6 m.

LED 4000 K. 14244 lm. 105,6 W.

Remote driver Built-in Micro. 1-10V.



ST115

Sketch composed by three identical compositions.

Each composition:

2 Sticks: 2 x 200 cm. Total 4 m.
 LED 4000 K. 9496 lm. 70,4 W.
 Built-in disc S canopy. 1-10V.

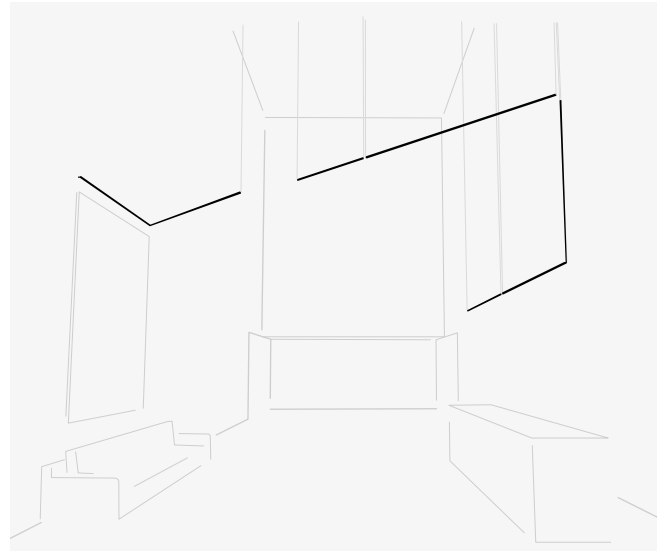

ST1131

Sketch composed by four compositions.

Composition 1:

2 Sticks: 2 x 300 cm. Total 6 m.
 LED 4000 K. 14244 lm. 105,6 W.
 Remote driver Built-in Micro. 1-10V.

Composition 2:

1 Stick: 1 x 150 cm. Total 1,5 m.
 LED 4000 K. 3561 lm. 26,4 W.
 Remote driver Built-in Micro. 1-10V.

Composition 3:

2 Sticks: 2 x 300 cm. Total 6 m.
 LED 4000 K. 14244 lm. 105,6 W.
 Remote driver Built-in Micro. 1-10V.

Composition 4:

2 Sticks: 2 x 300 cm. Total 6 m.
 LED 4000 K. 14244 lm. 105,6 W.
 Remote driver Built-in Micro. 1-10V.

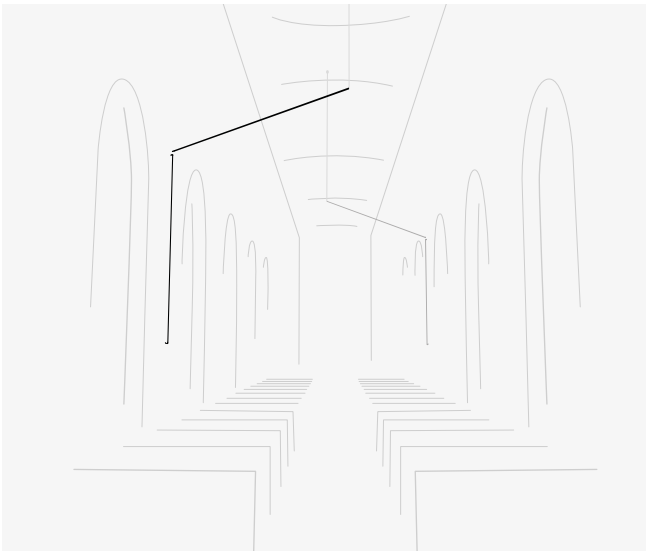

ST1141

Sketch composed by two identical compositions.

Each composition:

2 Sticks: 2 x 300 cm. Total 6 m.
 LED 4000 K. 14244 lm. 105,6 W.
 Built-in disc S canopy. 1-10V.

Sticks Connectable

Next sketches are composed by one or more compositions

Some sticks are attached to the Wall

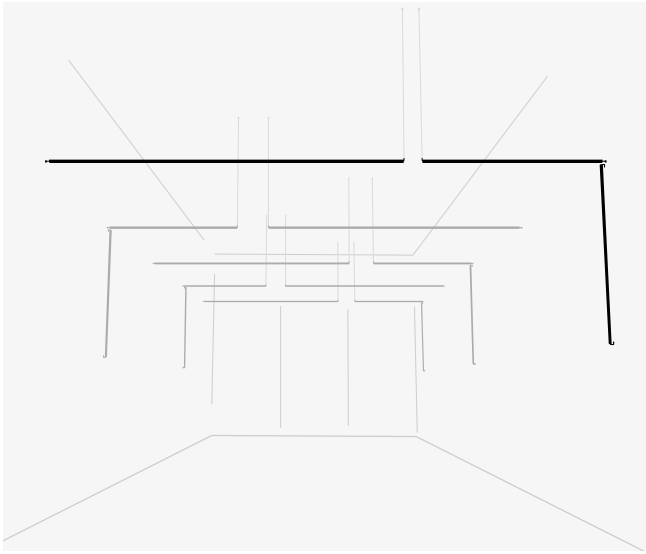

ST1145

Sketch composed by five identical compositions.

Each composition:

3 Sticks: 1 x 300 cm, 2 x 150 cm. Total 6 m.

LED 4000 K. 14244 lm. 105,6 W.

Remote driver Built-in Micro. 1-10V

Some sticks are on the Floor

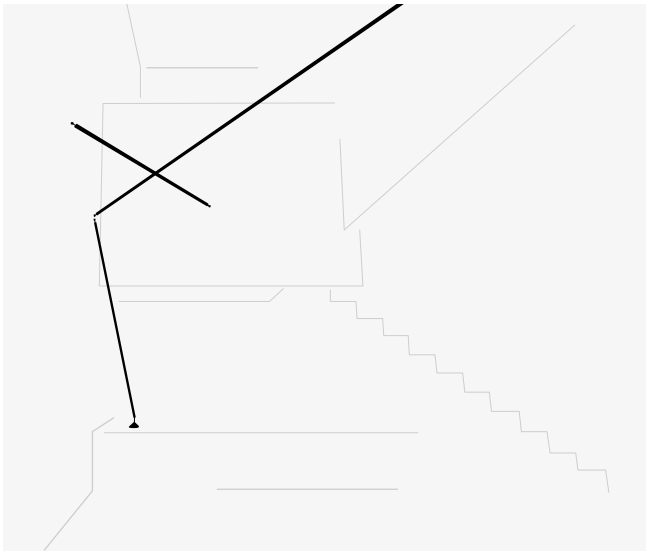

ST1151

Sketch composed by two compositions.

Composition 1:

1 Stick: 1 x 150 cm. Total 1,5 m.

LED 2700 K. 3260 lm. 26,4 W.

Remote driver Built-in Micro. 1-10V.

Composition 2:

2 Sticks: 1 x 200 cm, 1 x 300 cm. Total 5 m.

LED 2700 K. 10865 lm. 88 W.

Remote driver Built-in Micro. 1-10V.

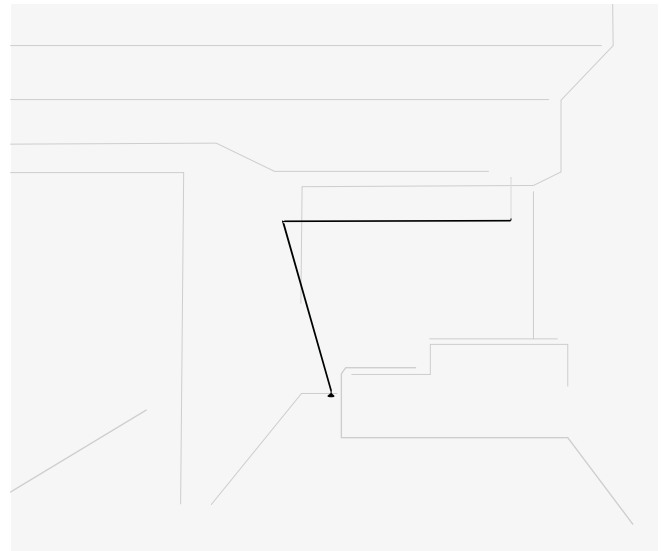

ST1155

Sketch composed by only one composition.

2 Sticks: 2 x 300 cm. Total 6 m.

LED 4000 K. 14244 lm. 105,6 W.

Floor base & plug. Push.

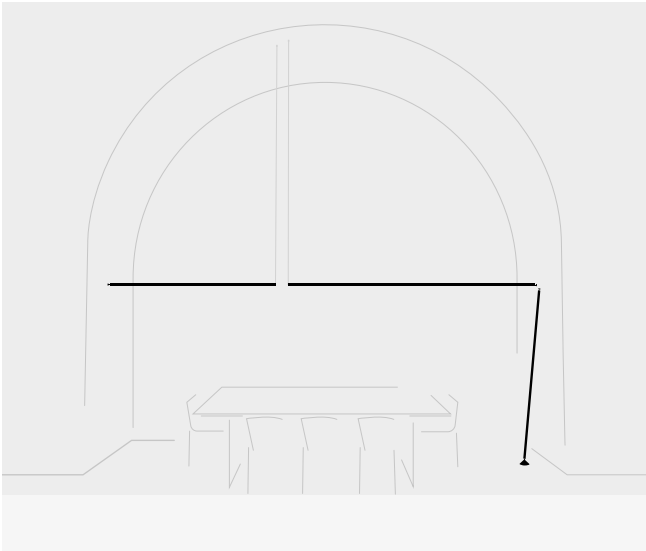

ST1161

Sketch composed by two compositions.

Composition 1:

1 Stick: 1 x 200 cm. Total 2 m.

LED 2700 K. 4336 lm. 35,2 W.

Remote driver Built-in Micro. 1-10V. Remote driver Built-in Micro. 1-10V.

Composition 2:

2 Sticks: 1 x 300 cm, 1 x 200 cm. Total 5 m.

LED 2700 K. 10865 lm. 88 W.

Remote driver Built-in Micro. 1-10V. Remote driver Built-in Micro. 1-10V.

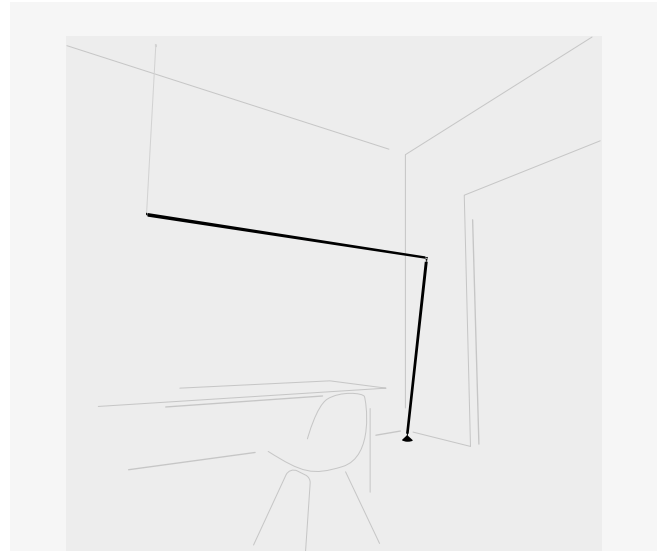

ST1165

Sketch composed by only one composition.

2 Sticks: 1 x 300 cm, 1 x 200 cm. Total 5 m.

LED 2700 K. 10865 lm. 88 W.

Floor base & plug. Push.



ST1171

Sketch composed by two compositions.

Composition 1:

3 Sticks: 3 x 200 cm. Total 6 m.

LED 4000 K. 14244 lm. 105,6 W.

Surface canopy. 1-10V.

Composition 2:

2 Sticks: 1 x 200 cm, 1 x 300 cm. Total 5 m.

LED 4000 K. 11870 lm. 88 W.

Surface canopy. 1-10V.

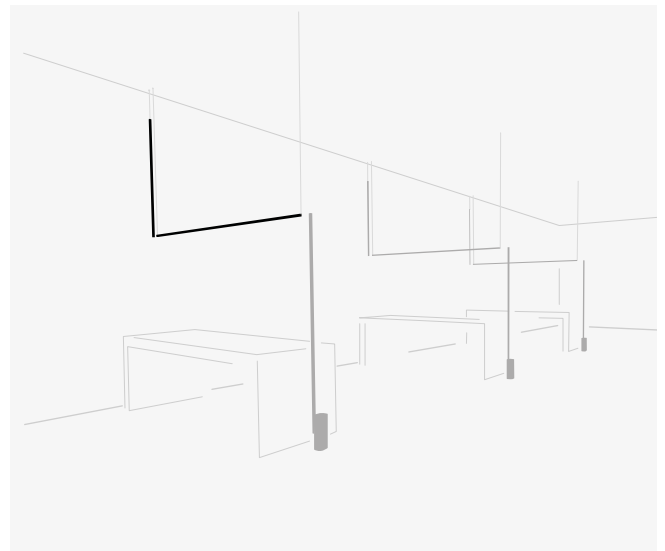

ST1175

Sketch composed by three identical compositions.

Each composition:

2 Sticks: 1 x 150 cm, 1 x 200 cm. Total 3,5 m.

LED 4000 K. 8309 lm. 61,6 W.

Surface canopy. 1-10V.



Each project is unique.
Visit vibia.com and chose among
multiple compositions designed
and adapted to your project needs.

Personalize your own Sticks composition
quick and easy at vibia.com.

Sticks Connectable



Elements to be configurated

Wall-Wall / Ceiling-Ceiling
Wall-Wall (corner) / Wall-Ceiling
Wall-Pendants
Pendants-Pendants
Pendants-Ceiling
Pendants

Sticks 1,5 m.

7300 7310 7320 7330 7350

LED temperature colour

- /1 _ 2700 K  CRI >90 3260 lm 123 lm/W
/2 _ 3000 K  CRI >90 3510 lm 133 lm/W
/4 _ 4000 K  CRI >90 3561 lm 134 lm/W

1 x LED STRIP 26,4 W 24V

Net weight 0,9 Kg.

Sticks 2 m.

7303 7313 7323 7333 7353

LED temperature colour

- /1 _ 2700 K  CRI >90 4346 lm 123 lm/W
/2 _ 3000 K  CRI >90 4680 lm 133 lm/W
/4 _ 4000 K  CRI >90 4748 lm 134 lm/W

1 x LED STRIP 35,2 W 24V

Net weight 1,2 Kg.

Sticks 3 m.

7306 7316 7326 7336 7356

LED temperature colour

- /1 _ 2700 K  CRI >90 6519 lm 123 lm/W
/2 _ 3000 K  CRI >90 7020 lm 133 lm/W
/4 _ 4000 K  CRI >90 7122 lm 134 lm/W

1 x LED STRIP 52,8 W 24V

Net weight 1,8 Kg.

Sticks: Aluminum.

Diffuser: Polycarbonate.

Driver and Dimming depends on selected installation accessory (see page 375).

Suspension cables up to 3m. for Wall - Pendants and Pendants-Pendants.

Personalisation options available

- Extra cable length for Wall - Pendants and Pendants - Pendants.

Min. quantity, upcharge and extra lead time apply.

11 Black

(NCS S 8500-N)

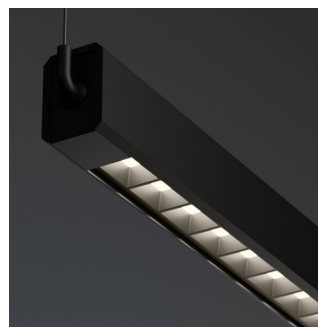

Horizontal Pendants version with a UGR index <19 available. Request more information.

Floor-Wall

Sticks 1,5 m.

7340

LED temperature colour

- /1 _ 2700 K  CRI >90 3260 lm 123 lm/W
/2 _ 3000 K  CRI >90 2644 lm 100,15 lm/W
/4 _ 4000 K  CRI >90 3561 lm 134 lm/W



1 x LED STRIP 26,4 W 24V

Net weight 1,5 Kg.

Sticks 2 m.

7343

LED temperature colour

- /1 _ 2700 K  CRI >90 4346 lm 123 lm/W
/2 _ 3000 K  CRI >90 2644 lm 100,15 lm/W
/4 _ 4000 K  CRI >90 4748 lm 134 lm/W

1 x LED STRIP 35,2 W 24V

Net weight 1,8 Kg.

Sticks 3 m.

7306 7316 7326 7336 7356

LED temperature colour

- /1 _ 2700 K  CRI >90 6519 lm 123 lm/W
/2 _ 3000 K  CRI >90 5288 lm 100,15 lm/W
/4 _ 4000 K  CRI >90 7122 lm 134 lm/W

1 x LED STRIP 52,8 W 24V

Net weight 2,4 Kg.

Sticks: Aluminum.

Diffuser: Polycarbonate.

Driver and Dimming depends on selected installation accessory (see page 375).

11 Black

(NCS S 8500-N)

Electrical connection options



Floor base & plug



Surface canopy



Built-in disc S



Remote driver Built-in Micro

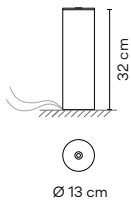

Floor base & plug
ACST000001 ACST000002
Driver Constant Voltage 24V.
90~305V. 50/60Hz.
Dimming: Push.

Materials
Body: Steel.
Packaging
1 Box.
0,16 x 0,16 x 0,4 m.
Vol. 0,01 m³.
Gross weight 8,5 Kg.
Net weight 7 Kg.

11 Black
(NCS S 8500-N)

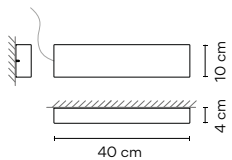

Surface canopy
ACST000003 ACST000004
Driver Constant Voltage 24V.
90~305V. 50/60Hz.
Dimming: 1-10V.

Personalisation options available
- Dimming: DALI, Casambi.
Min. quantity, upcharge and extra lead time apply.
To be installed on ceiling or wall.

Materials
Body: Steel.
Packaging
1 Box.
0,50 x 0,25 x 0,25 m.
Vol. 0,03 m³.
Gross weight 2,9 Kg.
Net weight 2,5 Kg.

11 Black
(NCS S 8500-N)

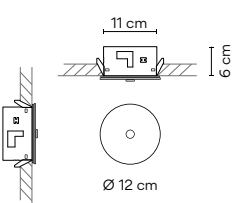

Built-in disc S
ACST000005 ACST000006
Driver Constant Voltage 24V.
90~305V. 50/60Hz.
Dimming: 1-10V.

Personalisation options available
- Dimming: DALI, Casambi.
Min. quantity, upcharge and extra lead time apply.
To be installed on ceiling or wall.

Materials
Body: Steel.
Packaging
1 Box.
0,25 x 0,25 x 0,25 m.
Vol. 0,01 m³.
Gross weight 1,8 Kg.
Net weight 1,5 Kg.

11 Black
(NCS S 8500-N)

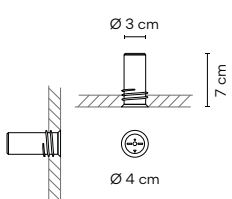

Remote driver Built-in Micro
ACST000007 ACST000008
Driver Constant Voltage 24V.
90~305V. 50/60Hz.
Dimming: 1-10V.

Personalisation options available
- Dimming: DALI, Casambi.
Min. quantity, upcharge and extra lead time apply.
To be installed on ceiling or wall.

Materials
Body: Aluminum.
Packaging
1 Box.
0,25 x 0,25 x 0,25 m.
Vol. 0,01 m³.
Gross weight 1,8 Kg.
Net weight 1,5 Kg.

11 Black
(NCS S 8500-N)



Sticks Stand-alone

Design by Arik Levy

Fusing technology, space, and architecture, Sticks offers a creative toolkit for integrating light elements in an interior. Pure and graphic, the minimalist aluminum rods transform linear light into floating sculpture.

Floor

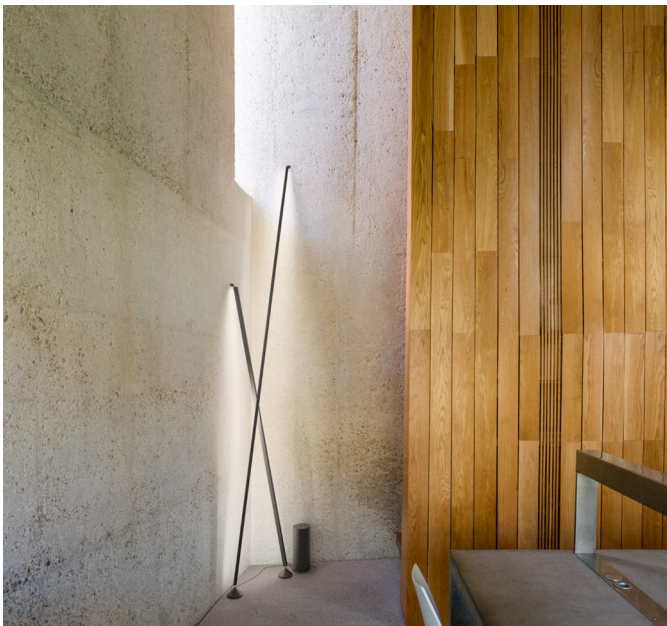
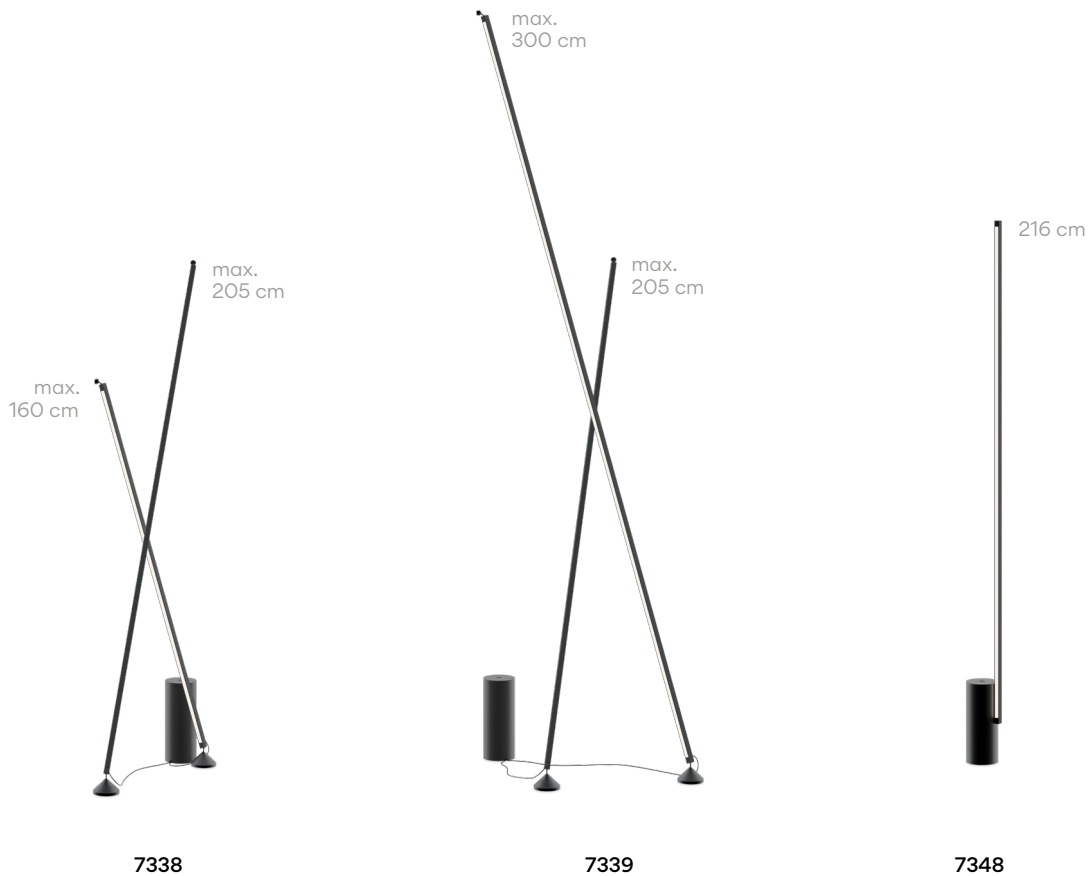

7338

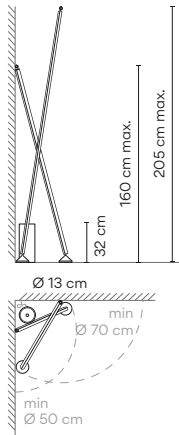

Finishes
 ● 11/ __ Black
 (NCS S 8500-N)

LED temperature colour
 /1 _ 2700 K
 CRI >90 7606 lm 123 lm/W
 /2 _ 3000 K
 CRI >90 7606 lm 123 lm/W
 /4 _ 4000 K
 CRI >90 8309 lm 134 lm/W

Control
 7338 __ / _ 5
 Push

Materials
 Sticks: Aluminum.
 Diffuser: Polycarbonate.

Light Source and electronics
 1 x LED STRIP 26,4 W 24V
 1 x LED STRIP 35,2 W 24V
 Constant Voltage 24V
 200~240V 50/60Hz

Packaging
 2 Boxes
 Total Vol 0,0414 m³
 Gross weight 14,2 Kg Net weight 9,7 Kg



7339

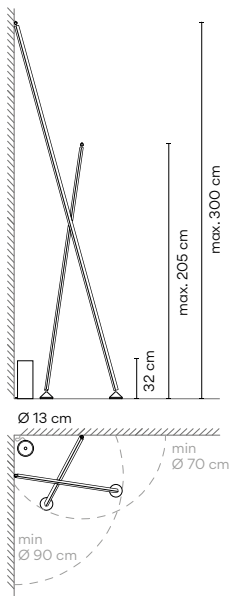

Finishes
 ● 11/ __ Black
 (NCS S 8500-N)

LED temperature colour
 /1 _ 2700 K
 CRI >90 10865 lm 123 lm/W
 /2 _ 3000 K
 CRI >90 7606 lm 123 lm/W
 /4 _ 4000 K
 CRI >90 11870 lm 134 lm/W

Control
 7339 __ / _ 5
 Push

Materials
 Sticks: Aluminum.
 Diffuser: Polycarbonate.

Light Source and electronics
 1 x LED STRIP 35,2 W 24V
 1 x LED STRIP 52,8 W 24V
 Constant Voltage 24V
 200~240V 50/60Hz

Packaging
 2 Boxes
 Total Vol 0,057 m³
 Gross weight 16,6 Kg Net weight 10,6 Kg



7348



Finishes
 ● 11/ __ Black
 (NCS S 8500-N)

LED temperature colour
 /1 _ 2700 K
 CRI >90 4346 lm 123 lm/W
 /2 _ 3000 K
 CRI >90 3511 lm 133 lm/W
 /4 _ 4000 K
 CRI >90 4748 lm 134 lm/W

Control
 7348 __ / _ 5
 Push

Materials
 Sticks: Aluminum.
 Diffuser: Polycarbonate.

Light Source and electronics
 1 x LED STRIP 35,2 W 24V
 Constant Voltage 24V
 200~240V 50/60Hz

Packaging
 2 Boxes
 Total Vol 0,0166 m³
 Gross weight 8,8 Kg Net weight 8,4 Kg



Musa

Design by Note Design Studio

Delicate elegance.
It explores the delicacy of nature
which is both strong and powerful,
in a poetic expression of light.

Table Wall

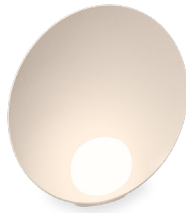

ø 26 cm

7400



ø 26 cm

7402 7404



ø 26 cm

7415

7400

Finishes

- 36/ __ Soft Pink (NCS S 1010-Y50R)
- 24/ __ Beige M1 (NCS S 2005-Y50R)
- 93/ __ White (RAL 9016)

Finish customization
(Available options:
Vibia colour palette)

LED temperature colour

/1_ 2700 K 
CRI >90 449 lm 100 lm/W

Control

7400 __ / _ 5
Push

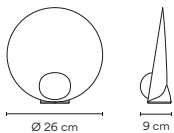

Materials

Diffuser: Blown glass.
Body: Aluminum.

Light Source and electronics





1 x LED 4,5 W 350 mA
Constant Voltage 24V
100~240V 50/60Hz

Packaging

1 Box 0,17 x 0,32 x 0,3 m
Vol 0,0163 m³
Gross weight 1,3 Kg Net weight 0,85 Kg

Notes

Dimmer switch on the base.
Electric cable with plug. 3 m

7402

Finishes

- 36/ __ Soft Pink (NCS S 1010-Y50R)
- 24/ __ Beige M1 (NCS S 2005-Y50R)
- 93/ __ White (RAL 9016)

Finish customization
(Available options:
Vibia colour palette)

LED temperature colour

/1_ 2700 K 
CRI >90 449 lm 100 lm/W

Control

7402 __ / _ 5
Push

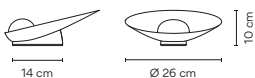

Materials

Diffuser: Blown glass.
Body: Aluminum.

Light Source and electronics





1 x LED 4,5 W 350 mA
Constant Voltage 24V
100~240V 50/60Hz

Packaging

1 Box 0,17 x 0,32 x 0,3 m
Vol 0,0163 m³
Gross weight 1,3 Kg Net weight 0,85 Kg

Notes

Dimmer switch on the base.
Electric cable with plug. 3 m

 

7404

- Finishes**
- **36/** _ _ Soft Pink (NCS S 1010-Y50R)
 - **24/** _ _ Beige M1 (NCS S 2005-Y50R)
 - **93/** _ _ White (RAL 9016)
- Finish customization**
 (Available options:
 Vibia colour palette)

LED temperature colour
 /1 _ 2700 K 
 CRI >90 157 lm 105 lm/W

Control
7404 _ _ / _ 5
 Push

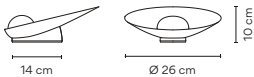

Materials
 Diffuser: Blown glass.
 Body: Aluminum.

Light Source and electronics
 1 x LED 1,5 W 500 mA
 Constant Voltage 5V
 100~240V 50/60Hz

Packaging
 1 Box 0,17 x 0,32 x 0,3 m
 Vol 0,0163 m³
 Gross weight 1,4 Kg Net weight 0,95 Kg

Notes
 Portable version with battery.
 Dimmer switch on the base. 3 step dimming.
 Electric cable with plug. 3 m.
 Battery life: from 6 to 18 hours
 (depending on intensity).



7415

- Finishes**
- **36/** _ _ Soft Pink (NCS S 1010-Y50R)
 - **24/** _ _ Beige M1 (NCS S 2005-Y50R)
 - **93/** _ _ White (RAL 9016)
- Finish customization**
 (Available options:
 Vibia colour palette)

LED temperature colour
 /1 _ 2700 K 
 CRI >90 449 lm 100 lm/W

Control
7415 _ _ / _ 3
 1-10V

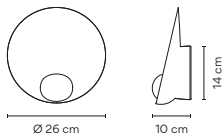

Materials
 Diffuser: Blown glass.
 Body: Aluminum.

Light Source and electronics
 1 x LED 4,5 W 350 mA
 Constant Current 350 mA
 220~240V 50/60Hz

Packaging
 1 Box 0,17 x 0,32 x 0,3 m
 Vol 0,0163 m³
 Gross weight 1,8 Kg Net weight 1,3 Kg



Knit

Design by Meike Harde

Form, materiality and tangibility collide with the Knit collection. Its texture is magnetic, calling out for us to touch its surface, to feel its warmth and to keep it close. Light seeps outwards through the fabric and downwards through a translucent screen, softening its luminosity.

Pendants



7450

Finishes
● 24/ _ Beige M1
(NCS S 2005-Y50R)

LED temperature colour
/1_ 2700 K 
CRI >90 7470 lm 133,9 lm/W

Control
7450 _ _ / _ 1
DALI
7450 _ _ / _ 3
1-10V
7450 _ _ / _ Z
Casambi

Electrical connection
Surface
_18 Free Wire
_23 Built-in
_31 Remote
Micro
for plaster
ceilings
_32 Remote
XXS
for all types
of drop
ceilings

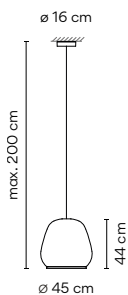

Materials
Fabric shade: Polyester flame retardant.
Shade: Polyethylene. Difuser: Methacrylate.
Difuser ring: ABS.

Light Source and electronics
6 x LED 5,9W 350 mA
Constant Current 1050 mA
110-240V 50/60Hz

Packaging
1 Box 0,55 x 0,55 x 0,65 m
Vol 0,196 m³
Gross weight 6 Kg Net weight 3,7 Kg

Notes
Extra cable length.

LED  IP20  CE  EAC   Bi-volt

1160 | 10 | /1A | _18 |

Model | Finish | LED temperature colour | Control | Electrical connection | Only for pendants



7455

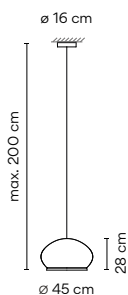

Finishes
● 24/ _ _ Beige M1
(NCS S 2005-Y50R)

LED temperature colour
/1 _ 2700 K 
CRI >90 7470 lm 133,9 lm/W

Control
7455 _ _ / _ 1
DALI

7455 _ _ / _ 3
1-10V

7455 _ _ / _ Z
Casambi

Materials
Fabric shade: Polyester flame retardant.
Shade: Polyethylene. Difuser: Methacrylate.
Difuser ring: ABS.

Light Source and electronics
6 x LED 5,9W 350 mA
Constant Current 1050 mA
110-240V 50/60Hz

Packaging
1 Box 0,54 x 0,54 x 0,41 m
Vol 0,119 m³
Gross weight 5,9 Kg Net weight 3,2Kg

Notes
Extra cable length.

Electrical connection
_18 Surface
_23 Free Wire
_23 Built-in
_31 Remote
_31 Remote
Micro
for plaster
ceilings
_32 Remote
XXS
for all types
of drop
ceilings

7460

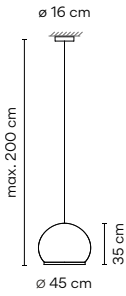

Finishes
● 24/ _ _ Beige M1
(NCS S 2005-Y50R)

LED temperature colour
/1_ 2700 K
CRI >90 7470 lm 133,9 lm/W

Control
7460 _ _ / _ 1
DALI

7460 _ _ / _ 3
1-10V

7460 _ _ / _ Z
Casambi

Materials
Fabric shade: Polyester flame retardant
Shade: Polyethylene Difuser: Methacrylate.
Difuser ring: ABS.

Light Source and electronics
6 x LED 5,9W 350 mA
Constant Current 1050 mA
110-240V 50/60Hz

Packaging
1 Box 0,54 x 0,54 x 0,41 m
Vol 0,119 m³
Gross weight 5,2 Kg Net weight 3,4Kg

Notes
Extra cable length.



Electrical connection
Surface
_18 Free Wire
_23 Built-in
_31 Remote
Micro
for plaster ceilings
_32 Remote
XXS
for all types of drop ceilings

7470

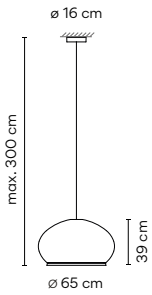

Finishes
● 24/ _ _ Beige M1
(NCS S 2005-Y50R)

LED temperature colour
/1_ 2700 K
CRI >90 7470 lm 133,9 lm/W

Control
7470 _ _ / _ 1
DALI

7470 _ _ / _ 3
1-10V

7470 _ _ / _ Z
Casambi

Materials
Fabric shade: Polyester flame retardant.
Shade: Polyethylene Difuser: Methacrylate.
Difuser ring: ABS.

Light Source and electronics
6 x LED 6,7W 400 mA
Constant Current 1200 mA
110-240V 50/60Hz

Packaging
1 Box 0,59 x 0,78 x 0,78m
Vol 0,358 m³
Gross weight 9Kg Net weight 5,5Kg

Notes
Extra cable length.



Electrical connection
Surface
_18 Free Wire
_23 Built-in
_31 Remote
Micro
for plaster ceilings
_32 Remote
XXS
for all types of drop ceilings

7475

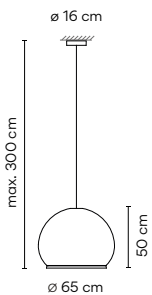

Finishes
● 24/ _ _ Beige M1
(NCS S 2005-Y50R)

LED temperature colour
/1_ 2700 K
CRI >90 7470 lm 133,9 lm/W

Control
7475 _ _ / _ 1
DALI

7475 _ _ / _ 3
1-10V

7475 _ _ / _ Z
Casambi

Materials
Fabric shade: Polyester flame retardant
Shade: Polyethylene Difuser: Methacrylate.
Difuser ring: ABS.

Light Source and electronics
6 x LED 6,7W 400 mA
Constant Current 1200 mA
110-240V 50/60Hz

Packaging
1 Box 0,80 x 0,80 x 0,77m
Vol 0,492 m³
Gross weight 9,5Kg Net weight 6Kg

Notes
Extra cable length.



Electrical connection
Surface
_18 Free Wire
_23 Built-in
_31 Remote
Micro
for plaster ceilings
_32 Remote
XXS
for all types of drop ceilings



Electrical connection options for models 7450 / 7455 / 7460 / 7470 / 7475

Choose your preferred installation option
according to your needs.
For each composition, the optimal minimum
number of drivers will be delivered.

Drop ceiling

The innovative remote and built-in fittings accentuate
the silkiness and lightness of compositions on
suspended ceilings, its great visual grandeur taking
center stage.

For Ref. 7450 / 7455 / 7460 / 7470 / 7475

Remote

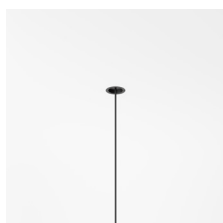

Micro ø 3 cm
height 7 cm
for plaster ceilings.
Black finish.

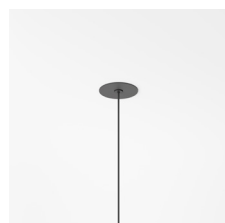
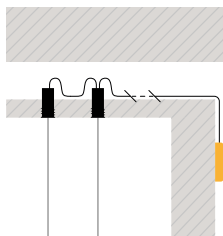

XXS ø 6 cm
height 6 cm
for all types of drop
ceilings. Match with
fixture finish.

Built-in



ø 8 cm
height 6 cm
match with
fixture finish.

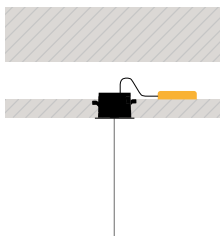

Regular ceiling

When architecture does not allow for performance, surface and free wire showcase possibilities for any need or desire with no limits, ideal for both individual or cluster arrangements.

For Ref. 7450 / 7455 / 7460 / 7470 / 7475

Surface



ø 16 cm

match with
fixture finish.

Free Wire

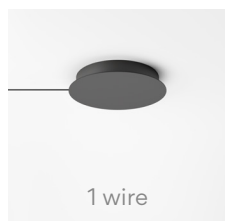

1 wire

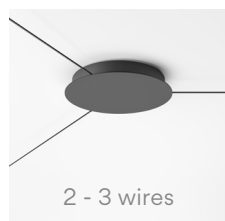

2 - 3 wires

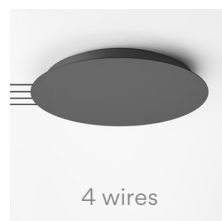

4 wires

ø 22 cm

ø 36 cm

ø 40 cm

you can choose the finish of the canopy
among black, white or any colour
matching one of the pendants.

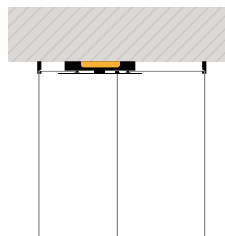
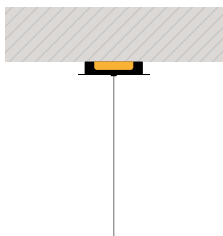

Floor



ø 45 cm

ø 65 cm

ø 65 cm



7480

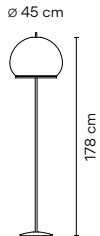

Finishes ● 24/ _ _ Beige M1 (NCS S 2005-Y50R)
 LED temperature colour /1 _ 2700 K CRI >90 4740 lm 133,9 lm/W

Control 7480 _ _ / _ 5
 Push 7480 _ _ / _ Z
 Casambi

Materials Fabric shade: Textile. Shade: Polyethylene. Difuser: Methacrylate. Difuser ring: ABS Tube: Iron steel. Base: Zamak.
 Light Source and electronics 6 x LED 5,9W 350 mA Constant Voltage 42V 1,43mA 110-240V 50/60Hz

Packaging 2 Boxes Box 1: 0,54 x 0,54 x 0,41 m Box 2: 1,71 x 0,38 x 0,36 m Total Vol. 0,353 m³ Gross weight 21,9 Kg Net weight 11,3 Kg
 Notes Electric cable 2,5 m



7485

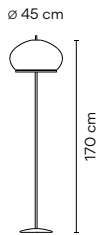

Finishes ● 24/ _ _ Beige M1 (NCS S 2005-Y50R)
 LED temperature colour /1 _ 2700 K CRI >90 4740 lm 133,9 lm/W

Control 7485 _ _ / _ 5
 Push 7485 _ _ / _ Z
 Casambi

Materials Fabric shade: Textile. Shade: Polyethylene. Difuser: Methacrylate. Difuser ring: ABS Tube: Iron steel. Base: Zamak.
 Light Source and electronics 6 x LED 5,9W 350 mA Constant Voltage 42V 1,43mA 110-240V 50/60Hz

Packaging 2 Boxes Box 1: 0,54 x 0,54 x 0,41 m Box 2: 1,71 x 0,38 x 0,36m Total Vol. 0,353m³ Gross weight 21,5Kg Net weight 10,8Kg
 Notes Electric cable 2,5 m



7487

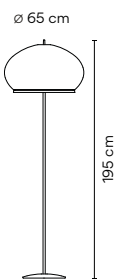

Finishes ● 24/ _ _ Beige M1 (NCS S 2005-Y50R)
 LED temperature colour /1 _ 2700 K CRI >90 4740 lm 133,9 lm/W

Control 7487 _ _ / _ 5
 Push 7487 _ _ / _ Z
 Casambi





Materials Fabric shade: Textile. Shade: Polyethylene. Difuser: Methacrylate. Difuser ring: ABS Tube: Iron steel. Base: Zamak.
 Light Source and electronics 6 x LED 5,9W 350 mA Constant Voltage 42V 1,43 mA 110-240V 50/60Hz

Packaging 2 Boxes Box 1: 0,78 x 0,78 x 0,59 m Box 2: 1,93 x 0,45 x 0,46 m Total Vol. 0,7579 m³ Gross weight 30 Kg Net weight 18,5 Kg
 Notes Electric cable 2,5 m

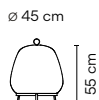







7490	Finishes	LED temperature colour	Control
	● 24/ _ _ Beige M1 (NCS S 2005-Y50R)	/1 _ 2700 K  CRI >90 4740 lm 133,9 lm/W	7490 _ _ / _ 5 Push 7490 _ _ / _ Z Casambi

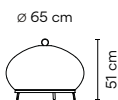

Materials	Packaging
Fabric shade: Textile Shade: Polyethylene. Difuser: Methacrylate. Difuser ring: ABS. Support: ABS.	1 Box 0,65 x 0,55 x 0,55 m Vol 0,196 m ³ Gross Weight 5,4 Kg Net Weight 3,3 Kg
Light Source and electronics	Notes
6 x LED 5,9 W 350 mA Constant Voltage 42V 1,43 mA 110-240V 50/60Hz	Electric cable 2,5 m
    	





7492	Finishes	LED temperature colour	Control
	● 24/ _ _ Beige M1 (NCS S 2005-Y50R)	/1 _ 2700 K  CRI >90 4740 lm 133,9 lm/W	7492 _ _ / _ 5 Push 7492 _ _ / _ Z Casambi

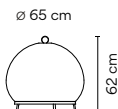

Materials	Packaging
Fabric shade: Textile. Shade: Polyethylene. Difuser: Methacrylate. Difuser ring: ABS. Support: ABS.	1 Box 0,78 x 0,78 x 0,59 m Vol 0,358 m ³ Gross Weight 7,3 Kg Net Weight 4,5 Kg
Light Source and electronics	Notes
6 x LED 5,9 W 350 mA Constant Voltage 42V 1,43 mA 110-240V 50/60Hz	Electric cable 2,5 m
    	

7494	Finishes	LED temperature colour	Control
	● 24/ _ _ Beige M1 (NCS S 2005-Y50R)	/1 _ 2700 K  CRI >90 4740 lm 133,9 lm/W	7494 _ _ / _ 5 Push 7494 _ _ / _ Z Casambi



Materials	Packaging
Fabric shade: Textile. Shade: Polyethylene. Difuser: Methacrylate. Difuser ring: ABS. Support: ABS.	1 Box 0,80 x 0,80 x 0,75 m Vol 0,48 m ³ Gross weight 9,3 Kg Net weight 5,9 Kg
Light Source and electronics	Notes
6 x LED 5,9 W 350 mA Constant Voltage 42V 1,43 mA 110-240V 50/60Hz	Electric cable 2,5 m
    	

1160 10 /1A
Model Finish
LED temperature colour
Control



Set

Design by Xuclà

A game of light, shadows and volumes, Set is a new concept of modular wall sconces that composes light as art onto the walls. During the day Set decorates the wall with a pattern of rectangular elements, but once illuminated it creates a surprising feature of lights, shadows and volumes.



Each project is unique. Visit vibia.com and chose among multiple compositions designed and adapted to your project needs.

Personalise your own Set composition quick and easy at vibia.com

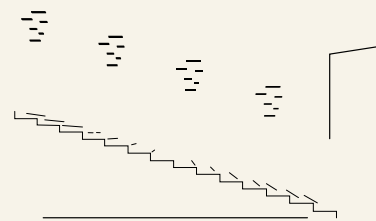
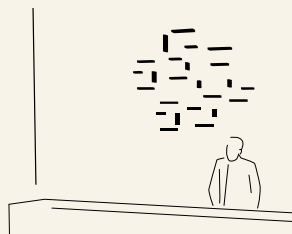
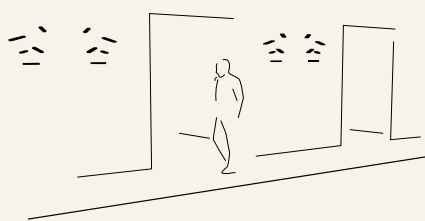

7753 x 3



7753 x 3



7750 x 1, 7751 x 3, 7752 x 1

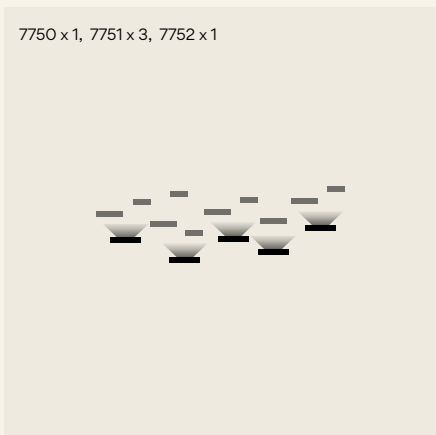

7760 x 1, 7761 x 1, 7762 x 2, 7763 x 1, 7764 x 1

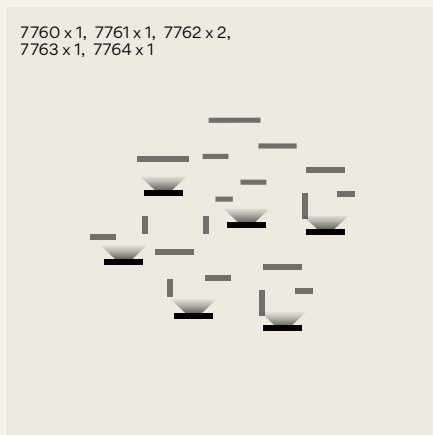

7749

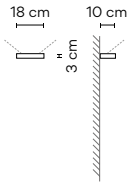

Finishes

- 59/ __ Mink (PANTONE 407)
- 93/ __ White (RAL 9003)

LED temperature colour

/1_ 2700 K CRI >90 1269 lm 141 lm/W

Control

7749 __ / _ 2
0-10V

Materials

Body: Aluminum. Diffuser: Borosilicate glass.
Lid: Polycarbonate.

Light Source and electronics

1 x LED 9 W 350 mA
Constant Current 350 mA
100~240V 50/60Hz

Packaging

1 Box 0,065 x 0,145 x 0,275 m
Vol 0,0026 m³
Gross weight 0,67 Kg Net weight 0,52 Kg

Notes

LED placed on the lower element.
Small

7750

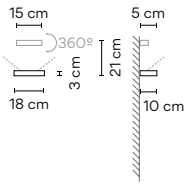

Finishes

- 59/ __ Mink (PANTONE 407)
- 93/ __ White (RAL 9003)

LED temperature colour

/1_ 2700 K CRI >90 1269 lm 141 lm/W

Control

7750 __ / _ 2
0-10V

Materials

Body: Aluminum. Diffuser: Borosilicate glass.
Reflector body: Foamed PVC. Lid: Polycarbonate.

Light Source and electronics

1 x LED 9 W 350 mA
Constant Current 350 mA
100~240V 50/60Hz

Packaging

1 Box 0,15 x 0,132 x 0,36 m
Vol 0,0071 m³
Gross weight 0,95 Kg Net weight 0,8 Kg

Notes

LED placed on the lower element.
Small

7751

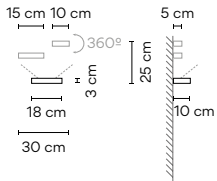

Finishes

- 59/ __ Mink (PANTONE 407)
- 93/ __ White (RAL 9003)

LED temperature colour

/1_ 2700 K CRI >90 1269 lm 141 lm/W

Control

7751 __ / _ 2
0-10V

Materials

Body: Aluminum. Diffuser: Borosilicate glass.
Reflector body: Foamed PVC. Lid: Polycarbonate.

Light Source and electronics

1 x LED 9 W 350 mA
Constant Current 350 mA
100~240V 50/60Hz

Packaging

1 Box 0,15 x 0,132 x 0,36 m
Vol 0,0071 m³
Gross weight 1,25 Kg Net weight 1,1 Kg

Notes

LED placed on the lower element.
Small

7752

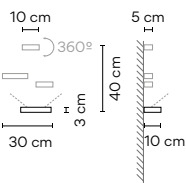

Finishes

- 59/ __ Mink (PANTONE 407)
- 93/ __ White (RAL 9003)

LED temperature colour

/1_ 2700 K CRI >90 1269 lm 141 lm/W

Control

7752 __ / _ 2
0-10V

Materials

Body: Aluminum. Diffuser: Borosilicate glass.
Reflector body: Foamed PVC. Lid: Polycarbonate.

Light Source and electronics

1 x LED 9 W 350 mA
Constant Current 350 mA
100~240V 50/60Hz

Packaging

1 Box 0,15 x 0,132 x 0,36 m
Vol 0,0071 m³
Gross weight 1,6 Kg Net weight 1,4 Kg

Notes

LED placed on the lower element.
Small

7753

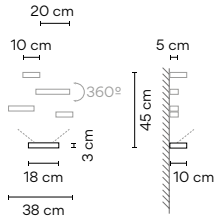

Finishes
 ● 59/ __ Mink (PANTONE 407)
 ● 93/ __ White (RAL 9003)

LED temperature colour
 /1_ 2700 K
 CRI >90 1269 lm 141 lm/W

Control
 7753 __ / _ 2
 0-10V

Materials
 Body: Aluminum. Diffuser: Borosilicate glass.
 Reflector body: Foamed PVC. Lid: Polycarbonate.

Light Source and electronics
 1 x LED 9 W 350 mA
 Constant Current 350 mA
 100~240V 50/60Hz

Packaging
 1 Box 0,15 x 0,193 x 0,36 m
 Vol 0,0100 m³
 Gross weight 2 Kg Net weight 1,5 Kg

Notes
 LED placed on the lower element.
 Small



7759

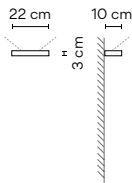

Finishes
 ● 59/ __ Mink (PANTONE 407)
 ● 93/ __ White (RAL 9003)

LED temperature colour
 /1_ 2700 K
 CRI >90 1269 lm 141 lm/W

Control
 7759 __ / _ 2
 0-10V

Materials
 Body: Aluminum. Diffuser: Borosilicate glass.
 Lid: Polycarbonate.

Light Source and electronics
 1 x LED 9 W 350 mA
 Constant Current 350 mA
 100~240V 50/60Hz

Packaging
 1 Box 0,065 x 0,145 x 0,275 m
 Vol 0,0026 m³
 Gross weight 0,75 Kg Net weight 0,6 Kg

Notes
 LED placed on the lower element.
 Big.

UNTIL STOCK RUNS OUT



7760

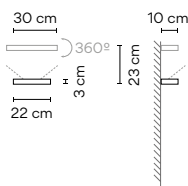

Finishes
 ● 59/ __ Mink (PANTONE 407)
 ● 93/ __ White (RAL 9003)

LED temperature colour
 /1_ 2700 K
 CRI >90 1269 lm 141 lm/W

Control
 7760 __ / _ 2
 0-10V

Materials
 Body: Aluminum. Diffuser: Borosilicate glass.
 Reflector body: Foamed PVC. Lid: Polycarbonate.

Light Source and electronics
 1 x LED 9 W 350 mA
 Constant Current 350 mA
 100~240V 50/60Hz

Packaging
 1 Box 0,15 x 0,132 x 0,36 m
 Vol 0,0071 m³
 Gross weight 1,4 Kg Net weight 1,1 Kg

Notes
 LED placed on the lower element.
 Big.

UNTIL STOCK RUNS OUT



7761

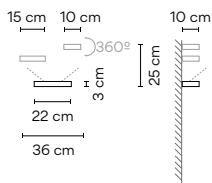

Finishes
 ● 59/ __ Mink (PANTONE 407)
 ● 93/ __ White (RAL 9003)

LED temperature colour
 /1_ 2700 K
 CRI >90 1269 lm 141 lm/W

Control
 7761 __ / _ 2
 0-10V

Materials
 Body: Aluminum. Diffuser: Borosilicate glass.
 Reflector body: Foamed PVC. Lid: Polycarbonate.

Light Source and electronics
 1 x LED 9 W 350 mA
 Constant Current 350 mA
 100~240V 50/60Hz

Packaging
 1 Box 0,15 x 0,132 x 0,36 m
 Vol 0,0071 m³
 Gross weight 1,5 Kg Net weight 1,2 Kg

Notes
 LED placed on the lower element.
 Big.

UNTIL STOCK RUNS OUT



7762

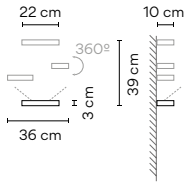

- Finishes
- 59/ __ Mink (PANTONE 407)
 - 93/ __ White (RAL 9003)

LED temperature colour
/1_ 2700 K
CRI >90 1269 lm 141 lm/W

Control
7762 __ / _ 2
0-10V

Materials
Body: Aluminum. Diffuser: Borosilicate glass.
Reflector body: Foamed PVC. Lid: Polycarbonate.

Light Source and electronics
1 x LED 9 W 350 mA
Constant Current 350 mA
100~240V 50/60Hz

Packaging
1 Box 0,15 x 0,193 x 0,36 m
Vol 0,0100 m³
Gross weight 1,9 Kg Net weight 1,9 Kg

Notes
LED placed on the lower element.
Big.

UNTIL STOCK RUNS OUT

7763

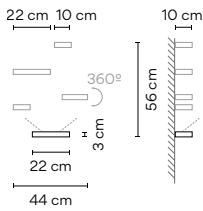

- Finishes
- 59/ __ Mink (PANTONE 407)
 - 93/ __ White (RAL 9003)

LED temperature colour
/1_ 2700 K
CRI >90 1269 lm 141 lm/W

Control
7763 __ / _ 2
0-10V

Materials
Body: Aluminum. Diffuser: Borosilicate glass.
Reflector body: Foamed PVC. Lid: Polycarbonate.

Light Source and electronics
1 x LED 9 W 350 mA
Constant Current 350 mA
100~240V 50/60Hz

Packaging
1 Box 0,15 x 0,193 x 0,36 m
Vol 0,0100 m³
Gross weight 2,25 Kg Net weight 1,75 Kg

Notes
LED placed on the lower element.
Big.

UNTIL STOCK RUNS OUT

7764

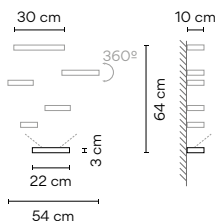

- Finishes
- 59/ __ Mink (PANTONE 407)
 - 93/ __ White (RAL 9003)

LED temperature colour
/1_ 2700 K
CRI >90 1269 lm 141 lm/W

Control
7764 __ / _ 2
0-10V

Materials
Body: Aluminum. Diffuser: Borosilicate glass.
Reflector body: Foamed PVC. Lid: Polycarbonate.

Light Source and electronics
1 x LED 9 W 350 mA
Constant Current 350 mA
100~240V 50/60Hz

Packaging
1 Box 0,15 x 0,193 x 0,36 m
Vol 0,0100 m³
Gross weight 2,75 Kg Net weight 2,25 Kg

Notes
LED placed on the lower element.
Big.

UNTIL STOCK RUNS OUT

1160 10 /1A
Model Finish
LED temperature colour
Control

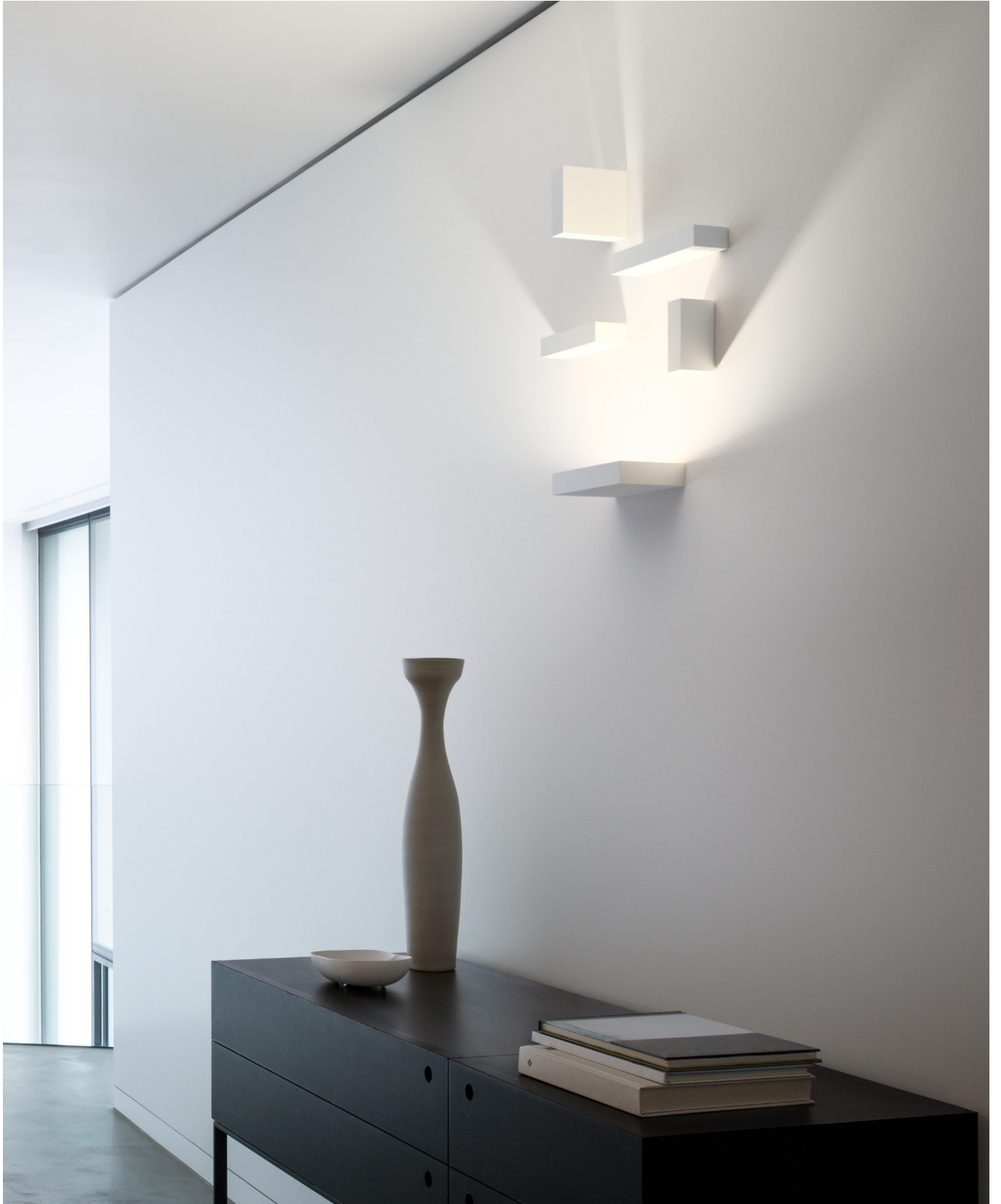

Alpha

Design by Ramos & Bassols

An embedded light breaking free to serve.

Wall



∅ 10,5 cm

7920



8 cm

7925



5 cm

7930



10,5 cm

7935



12 x 12 cm

7940 7942*



24 cm

7955



14 x 24 cm

7950

7920

Finishes

- 03/ __ White and chrome (RAL 9016)
- 04/ __ Black and chrome (RAL 9005)
- 18/ __ Graphite and black (RAL 7016)
- 93/ __ White (RAL 9016)

LED temperature colour

/1_ 2700 K 
CRI >90 181,2 lm 86 lm/W

Control

7920 __ / _ 0
On/ Off

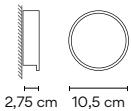

Materials

Box: Zamak. Diffuser: Polycarbonate.
Lid: Steel.

Light Source and electronics

1 x LED 2,1 W 700 mA
Constant Current 700 mA
100~240V 50/60Hz

Packaging

1 Box 0,13 x 0,20 x 0,21 m
Vol 0,0055 m³
Gross weight 1 Kg Net weight 0,444 Kg

Notes

Surface.

UNTIL STOCK RUNS OUT

LED  IP20  CE  EAC   Bi-volt

7925

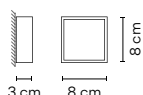

<p>Finishes</p> <ul style="list-style-type: none"> ● 03/ __ White and chrome (RAL 9016) ● 04/ __ Black and chrome (RAL 9005) ● 18/ __ Graphite and black (RAL 7016) ● 93/ __ White (RAL 9016) 	<p>LED temperature colour</p> <p>/1 _ 2700 K G CRI >90 181,2 lm 86 lm/W</p>	<p>Control</p> <p>7925 __ / _ 0 On/ Off</p>
<p>Materials</p> <p>Box: Zamak. Diffuser: Polycarbonate. Lid: Steel.</p> <p>Light Source and electronics</p> <p>1 x LED 2,1 W 700 mA Constant Current 700 mA 100~240V 50/60Hz</p>	<p>Packaging</p> <p>1 Box 0,13 x 0,21 x 0,20 m Vol 0,0055 m³ Gross weight 1 Kg Net weight 0,32 Kg</p> <p>Notes</p> <p>Surface. UNTIL STOCK RUNS OUT</p> <p> </p>	

7930

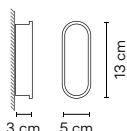

<p>Finishes</p> <ul style="list-style-type: none"> ● 03/ __ White and chrome (RAL 9016) ● 04/ __ Black and chrome (RAL 9005) ● 18/ __ Graphite and black (RAL 7016) ● 93/ __ White (RAL 9016) 	<p>LED temperature colour</p> <p>/1 _ 2700 K G CRI >90 181,2 lm 86 lm/W</p>	<p>Control</p> <p>7930 __ / _ 0 On/ Off</p>
<p>Materials</p> <p>Box: Zamak. Diffuser: Polycarbonate. Lid: Steel.</p> <p>Light Source and electronics</p> <p>2 x LED 2,1 W 700 mA Constant Current 700 mA 100~240V 50/60Hz</p>	<p>Packaging</p> <p>1 Box 0,13 x 0,20 x 0,21 m Vol 0,0055 m³ Gross weight 0,9 Kg Net weight 0,3 Kg</p> <p>Notes</p> <p>Surface. UNTIL STOCK RUNS OUT</p> <p> </p>	

7935

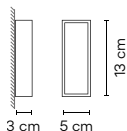

<p>Finishes</p> <ul style="list-style-type: none"> ● 03/ __ White and chrome (RAL 9016) ● 04/ __ Black and chrome (RAL 9005) ● 18/ __ Graphite and black (RAL 7016) ● 93/ __ White (RAL 9016) 	<p>LED temperature colour</p> <p>/1 _ 2700 K G CRI >90 362,4 lm 86 lm/W</p>	<p>Control</p> <p>7935 __ / _ 0 On/ Off</p>
<p>Materials</p> <p>Box: Zamak. Diffuser: Polycarbonate. Lid: Steel.</p> <p>Light Source and electronics</p> <p>2 x LED 2,1 W 700 mA Constant Current 700 mA 100~240V 50/60Hz</p>	<p>Packaging</p> <p>1 Box 0,13 x 0,20 x 0,21 m Vol 0,0055 m³ Gross weight 0,9 Kg Net weight 0,3 Kg</p> <p>Notes</p> <p>Surface. UNTIL STOCK RUNS OUT</p> <p> </p>	

7940

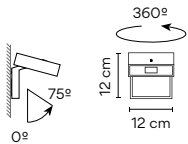

- Finishes**
- **03/** __ White and chrome (RAL 9016)
 - **04/** __ Black and chrome (RAL 9005)
 - **18/** __ Graphite and black (RAL 7016)
 - **93/** __ White (RAL 9016)

LED temperature colour
/1 2700 K
 CRI >90 181,22 lm 86 lm/W

Control
7940 __ / __ **0**
 On/ Off

Materials
 Diffuser: Polycarbonate. Lid: Zamak.
 Body: Aluminum. Lid: Aluminum.

Light Source and electronics
 1 x LED 2,1 W 700 mA
 Constant Current 700 mA
 100~240V 50/60Hz

Packaging
 1 Box 0,13 x 0,20 x 0,20 m
 Vol 0,0055 m³
 Gross weight 1,2 Kg Net weight 1 Kg

Notes
 Surface
 On/off switch on the front cover



7942

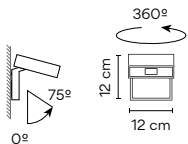

- Finishes**
- **03/** __ White and chrome (RAL 9016)
 - **04/** __ Black and chrome (RAL 9005)
 - **18/** __ Graphite and black (RAL 7016)
 - **93/** __ White (RAL 9016)

LED temperature colour
/1 2700 K
 CRI >90 181,22 lm 86 lm/W

Control
7942 __ / __ **0**
 On/ Off

Materials
 Diffuser: Polycarbonate. Lid: Zamak.
 Body: Aluminum. Lid: Aluminum.

Light Source and electronics
 1 x LED 2,1 W 700 mA
 Constant Current 700 mA
 100~240V 50/60Hz

Packaging
 1 Box 0,13 x 0,20 x 0,20 m
 Vol 0,0055 m³
 Gross weight 1,2 Kg Net weight 1 Kg

Notes
 Surface
 Without switch



7950

- Finishes
- 03/ _ _ White and chrome (RAL 9016)
 - 04/ _ _ Black and chrome (RAL 9005)

LED temperature colour
 /1_ 2700 K 
 CRI >90 543,6 lm 86 lm/W

Control
 7950 _ _ / _ 0
 On/ Off

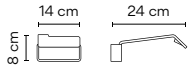

Materials
 Diffuser: Polycarbonate. Lid: Zamak.
 Body: Aluminum. Lid: Aluminum.

Light Source and electronics
 3 x LED 2,1 W 700 mA
 Constant Current 700 mA
 100~240V 50/60Hz

Packaging
 1 Box 0,26 x 0,26 x 0,26 m
 Vol 0,0175 m³
 Gross weight 1,56 Kg Net weight 0,65 Kg

Notes
 Surface
 Light beam with no IR and UV.
UNTIL STOCK RUNS OUT



7955

- Finishes
- 03/ _ _ White (RAL 9016)
 - 04/ _ _ Black (RAL 9005)

LED temperature colour
 /1_ 2700 K 
 CRI >90 543,6 lm 86 lm/W

Control
 7955 _ _ / _ 0
 On/ Off

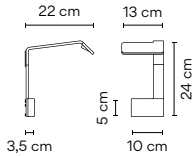

Materials
 Diffuser: Polycarbonate. Lid: Zamak.
 Body: Aluminum. Lid: Aluminum.

Light Source and electronics
 3 x LED 2,1 W 700 mA
 Constant Current 700 mA
 100~240V 50/60Hz

Packaging
 1 Box 0,23 x 0,37 x 0,37 m
 Vol 0,0310 m³
 Gross weight 0,97 Kg Net weight 0,47 Kg

Notes
 Surface
 Light beam with no IR and UV.
UNTIL STOCK RUNS OUT



Domo

Design by Ramos & Bassols

Featuring a classic cylinder silhouette, Domo offers refined lighting effect, combining diffusion and reflection. The understated, LED-powered fixture has clean lines and a spherical shape that seamlessly blends into the ceiling architecture.

Ceiling

8200

ø 18,5 cm



8201

ø 18,5 cm



8200

Finishes

- 03/ __ White (RAL 9010)

LED temperature colour

- /1_ 2700 K CRI >90 543,66 lm 86 lm/W
- /2_ 3000 K CRI >90 489,6 lm 78 lm/W
- /3_ 3500 K CRI >90 393,6 lm 62,5 lm/W

Control

- 8200 __ / _ 0 On / Off
- 8200 __ / _ 2 0-10V

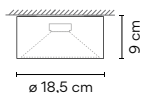

Materials

Diffuser: Polycarbonate.
Body: Aluminum.

Light Source and electronics

3 x LED 2,1 W 700 mA
Constant Current 700 mA
100~240V 50/60Hz
/ _ 0: On/Off, 100~240V Bi-volt
/ _ 2: 0-10V, 100~277V Multi-volt

Packaging

1 Box 0,26 x 0,26 x 0,26 m
Vol 0,0170 m³
Gross weight 1,7 Kg Net weight 1,2 Kg

Notes

Surface fitting.

UNTIL STOCK RUNS OUT

8201

Finishes

- 03/ __ White (RAL 9010)

LED temperature colour

- /1_ 2700 K CRI >90 543,66 lm 86 lm/W
- /2_ 3000 K CRI >90 489,6 lm 78 lm/W
- /3_ 3500 K CRI >90 393,6 lm 62,5 lm/W

Control

- 8201 __ / _ 0 On / Off
- 8201 __ / _ 2 0-10V

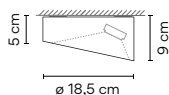

Materials

Diffuser: Polycarbonate.
Body: Aluminum.

Light Source and electronics

3 x LED 2,1 W 700 mA
Constant Current 700 mA
100~240V 50/60Hz
/ _ 0: On/Off, 100~240V Bi-volt
/ _ 2: 0-10V, 100~277V Multi-volt

Packaging

1 Box 0,26 x 0,26 x 0,26 m
Vol 0,0170 m³
Gross weight 1,6 Kg Net weight 1,1 Kg

Notes

Surface fitting.

UNTIL STOCK RUNS OUT



45°

Design by Víctor Carrasco

45° fixture features a customised composition of vertical tubes that create a sculptural effect overhead. Suspended from the ceiling like sleek stalagmites, they create an array of glowing accent lighting points.

Ceiling



8250

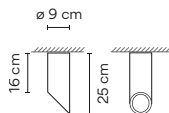

Finishes <ul style="list-style-type: none"> ● 03/ __ White (RAL 9016) ● 04/ __ Black (RAL 9005) 	LED temperature colour <ul style="list-style-type: none"> /1 _ 2700 K E >90 1352,27 lm 101 lm/W /2 _ 3000 K E >90 662 lm 49 lm/W /3 _ 3500 K F >90 1463,02 lm 109,18 lm/W 	Control <ul style="list-style-type: none"> 8250 __ / _ 3 1-10V 8250 __ / _ 5 Push
---	---	---

Finishes <ul style="list-style-type: none"> ● 52/ __ Black oxide (Satin bronze) 	LED temperature colour <ul style="list-style-type: none"> /1 _ 2700 K E >90 1352,27 lm 101 lm/W /2 _ 3000 K E >90 662 lm 49 lm/W /3 _ 3500 K F >90 1463,02 lm 109,18 lm/W 	Control <ul style="list-style-type: none"> 8250 __ / _ 3 1-10V 8250 __ / _ 5 Push
---	---	---

Materials

Diffuser: Polycarbonate.
Tube: Aluminum.

Light Source and electronics

1 x LED 6,1 W 350 mA
Constant Current 350 mA
230V 50Hz

Packaging

1 Box 0,21 x 0,21 x 0,48 m
Vol 0,0211 m³
Gross weight 2,1 Kg Net weight 1,15 Kg

Notes

Surface fitting.
It includes interchangeable diffusers, mink or orange finishes

UNTIL STOCK RUNS OUT

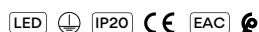

8251

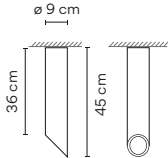

Finishes	LED temperature colour	Control
● 03/ __ White (RAL 9016)	/1 _ 2700 K E > CRI >90 1352,27 lm 101 lm/W	8251 __ / _ B 1-10V, Push
● 04/ __ Black (RAL 9005)	/2 _ 3000 K E > CRI >90 662 lm 49 lm/W	8251 __ / _ 1 DALI
	/3 _ 3500 K F > CRI >90 1463,02 lm 109,18 lm/W	

Finishes	LED temperature colour	Control
● 52/ __ Black oxide (Satin bronze)	/1 _ 2700 K E > CRI >90 1352,27 lm 101 lm/W	8251 __ / _ B 1-10V, Push
	/2 _ 3000 K E > CRI >90 662 lm 49 lm/W	8251 __ / _ 1 DALI
	/3 _ 3500 K F > CRI >90 1463,02 lm 109,18 lm/W	

Materials
 Diffuser: Polycarbonate.
 Tube: Aluminum.

Light Source and electronics
 1 x LED 6,1 W 350 mA
 Constant Current 350 mA
 110-240V 50/60Hz

Packaging
 1 Box 0,21 x 0,21 x 0,48 m
 Vol 0,0326 m³
 Gross weight 2,9 Kg Net weight 1,95 Kg

Notes
 Surface fitting.
 It includes interchangeable diffusers, mink or orange finishes

UNTIL STOCK RUNS OUT

LED IP20 CE EAC Bi-volt

8252

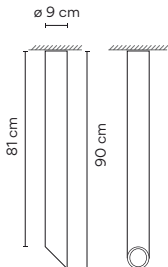

Finishes	LED temperature colour	Control
● 03/ __ White (RAL 9016)	/1 _ 2700 K E > CRI >90 1352,3 lm 101 lm/W	8252 __ / _ B 1-10V, Push
● 04/ __ Black (RAL 9005)	/2 _ 3000 K E > CRI >90 662 lm 49 lm/W	8252 __ / _ 1 DALI
	/3 _ 3500 K F > CRI >90 1463,02 lm 109,18 lm/W	

Finishes	LED temperature colour	Control
● 52/ __ Black oxide (Satin bronze)	/1 _ 2700 K E > CRI >90 1352,3 lm 101 lm/W	8252 __ / _ B 1-10V, Push
	/2 _ 3000 K E > CRI >90 662 lm 49 lm/W	8252 __ / _ 1 DALI
	/3 _ 3500 K F > CRI >90 1463,02 lm 109,18 lm/W	

Materials
 Diffuser: Polycarbonate.
 Tube: Aluminum.

Light Source and electronics
 1 x LED 6,1 W 350 mA
 Constant Current 350 mA
 110-240V 50/60Hz

Packaging
 1 Box 0,19 x 0,13 x 1,265 m
 Vol 0,0312 m³
 Gross weight 6,25 Kg Net weight 4,75 Kg

Notes
 Surface fitting.
 It includes interchangeable diffusers, mink or orange finishes

UNTIL STOCK RUNS OUT

LED IP20 CE EAC Bi-volt

Match

Design by Jordi Vilardell & Meritxell Vidal

Based on the principle of co-creation, Match is a lighting collection that can be fully customised virtually. Sculptural light structures arranged chaotically and adapted to fit into the room and the space available.

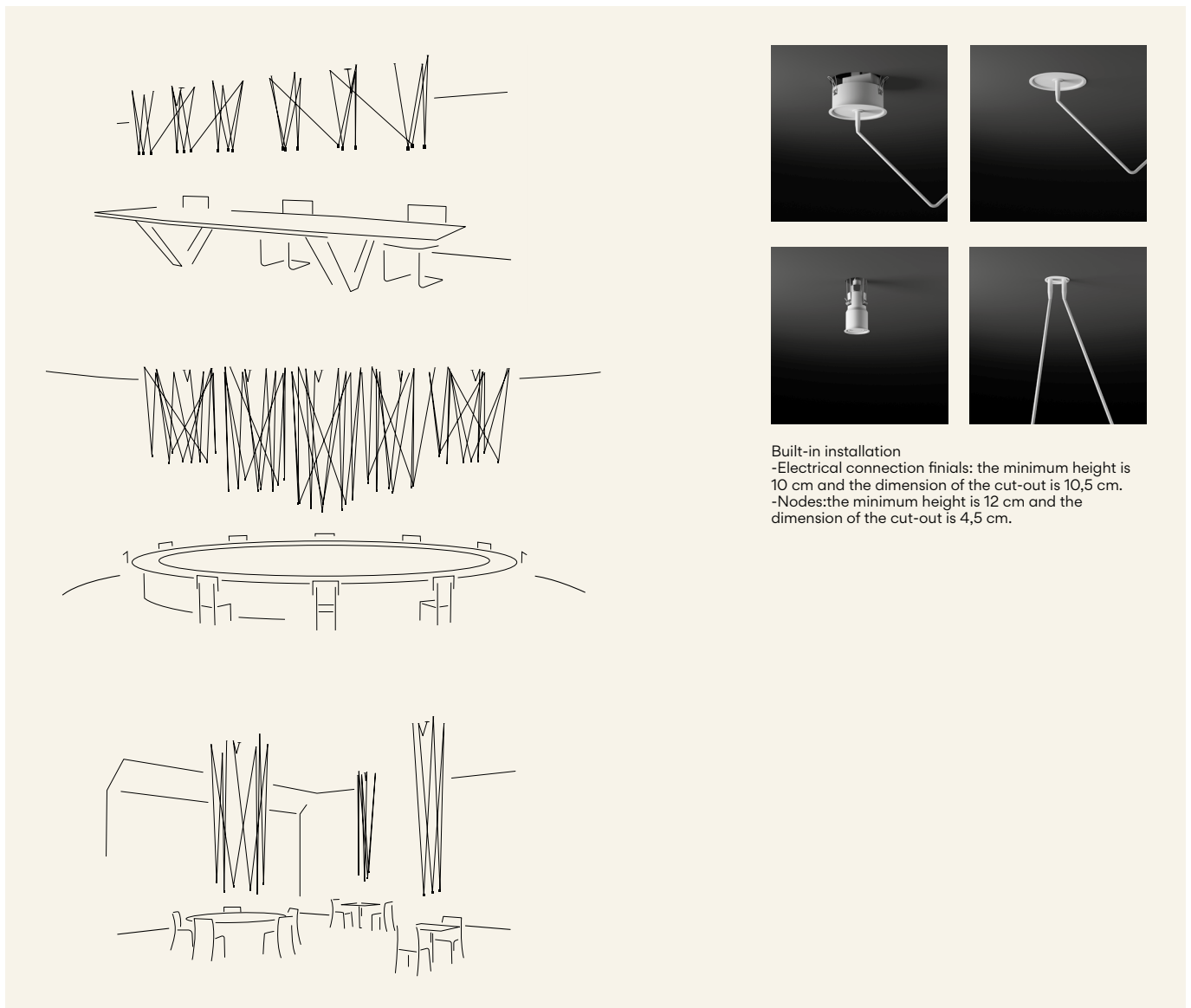

Built-in installation
-Electrical connection finials: the minimum height is 10 cm and the dimension of the cut-out is 10,5 cm.
-Nodes: the minimum height is 12 cm and the dimension of the cut-out is 4,5 cm.

Each project is unique. Visit vibia.com and chose among multiple compositions designed and adapted to your project needs.

Personalise your own Match composition quick and easy at vibia.com

It's necessary to make your personalized configuration on vibia.com to see prices and place orders.

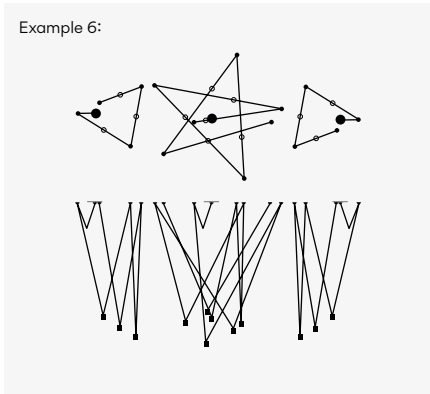
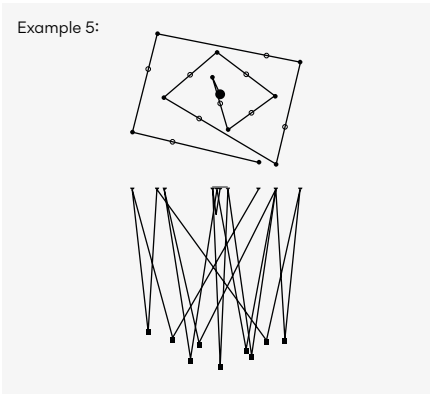
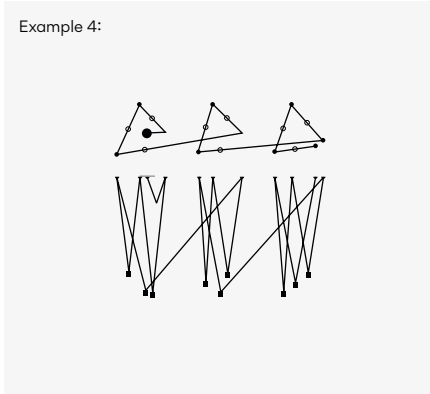
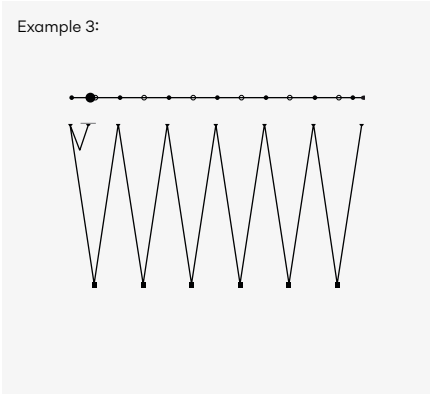
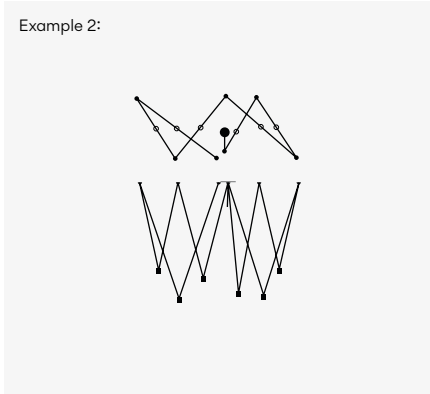
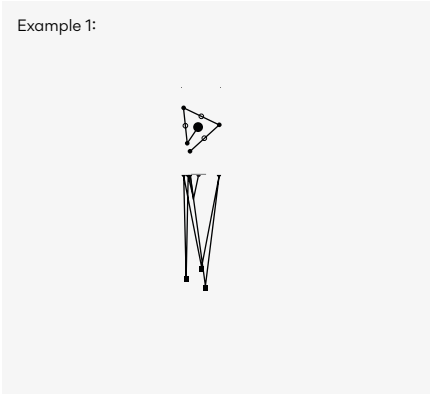

- Finishes**
- **03/ _ _ White**
(RAL 9010)
 - **18/ _ _ Graphite**
(RAL 7016)

LED temperature colour
/1_ 2700 K **G**
CRI >80 199 lm 95 lm/W

Control
A
DALI-2, 1-10V, Push
Z
Casambi

Materials
Head: Aluminum. Canopy Plate: Steel.
Rods: Steel.













Light Source and electronics
LED 2,1 W 700 mA
Constant Current 700 mA
110-240V 50/60Hz

Notes
Built-in
LED IP20 Bi-volt
 ø 4,5 cm ø 10,5 cm

PLACE ORDER ONLINE AT WWW.VIBIA.COM



Bulbs

LED		Fluorescent tube	
900018.	LED G9 4,2W 2700K 470 lm.		900027. G5 230V 24W (T5) 
900100.	LED G9 230V 3,8W LED 2700 K 470 lm		900028. G5 230V 39W (T5) 
900102.	LED E27 230V 12W LED 2700 K 1520 lm		900035. 2GX13 230V 55W (T5C) 
900103.	LED E27 230V 9W 2700 K 800 lm		900070. 2GX13 230V 40W (T5C) 
900105.	LED E27 PAR30 230V 10W 2700 K 630 lm		900071. 2GX13 230V 22W (T5C) 
900106.	LED E14 230V 7W LED 2700 K 800 lm.		900072. 2GX13 230V 60W (T5C) 

Professional area at vibia.com

A new way of Working

We believe in cooperation and we bring you new ways to collaborate and online tools at vibia.com that we will help to work together efficiently. We propose a new way of working to have successful lighting projects.

Download all the information you need

Download and export all product information you need for your projects in one click:



Spec sheet

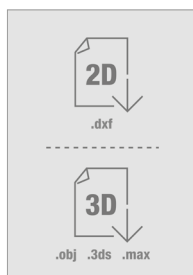

2D, 3D

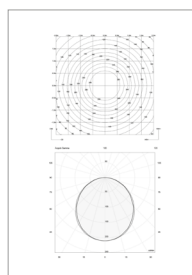

Photometry



HD images

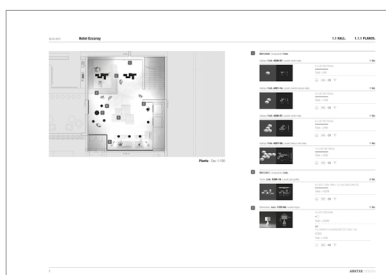

Project report

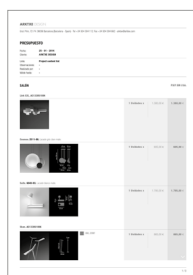

Budgets

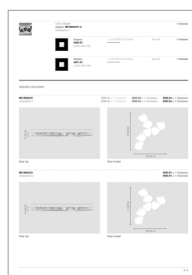

Product configuration spec sheet

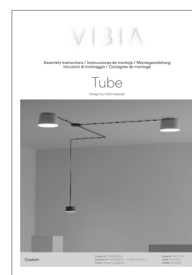

Installation instructions

Glossary

CE

Product complying with the EN60598-1 and EN60598-2-1 European regulation.



Product complying with TP TC 004/2011 and TP TC 020/2011. Custom Union Regulation



Product that complies with the law N24-09 of the current Moroccan legislation.

IP

Level of protection. Electrical products are prepared to avoid solids and liquids from getting in contact with the electrical parts. Such resistance is expressed as IP followed by two digits: the first digit indicates the level of resistance to solid objects and the second one to liquids. The scale goes from IP20 to IP68.



Product protected against solid object as big as or bigger than 12 mm. No protection against water.



Dust-tight product. Protected against water spray.



Dust-tight product. Protected against water trickles.



Dust-tight product. Protected against water spurts.

Insulation class



Class I. Product with an additional protection cable (grounds).



Class II. Product protected against electric shock having a double insulation. No grounds.



Class III. Product protected against electric shock based on a very-low voltage system. No grounds.

Flammable surfaces



Product suitable to be installed on any kind of surface (EN 60598).



Product that **CANNOT** be in contact with normally-flammable materials (wood or others).



Valid for the range 110V-230V, 50-60Hz.



Valid for the range 110-277V, 50-60Hz.



Contains lithium-ion battery. Li-Ion battery must be disposed of into label containers, returned to special waste collection points or retailers of electrical equipment.

Cut out



Property for embedding dimension.

No electronic equipment included



The lamp does not include any electronic equipment (transformer, driver, ballast...).

Integrated Dimmer



Lamp that has a integrated dimmer.

EU Energetic label

More Efficacy



Less Efficacy

Light source information

CRI
Colour rendering index.

K
Colour temperature.

lm
Lumen, unit of measurement of luminous flux.

lm/W
Light source performance. Relationship between the luminous flux (lm) and the power consumed (W) by the source.



LED included.

Lighting control systems

1 Push control

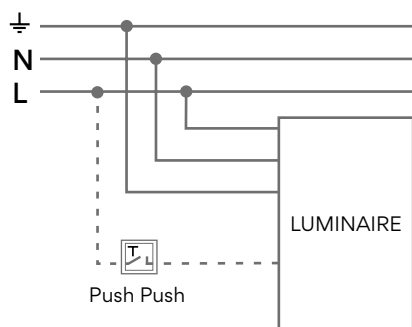

2 1-10V System control

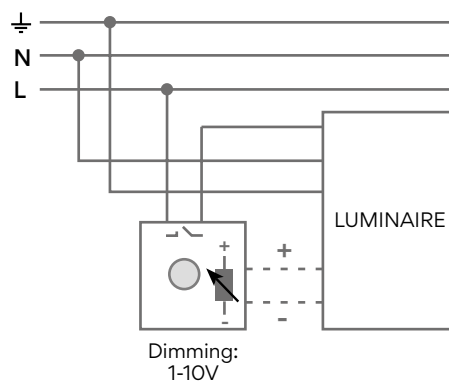

3 DALI System control

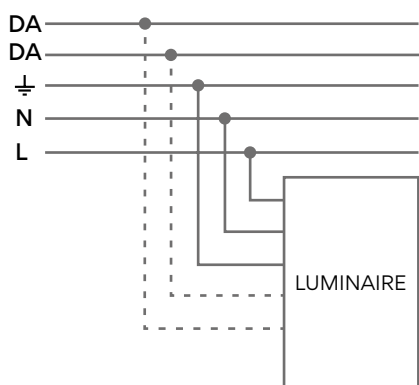

4 Casambi control

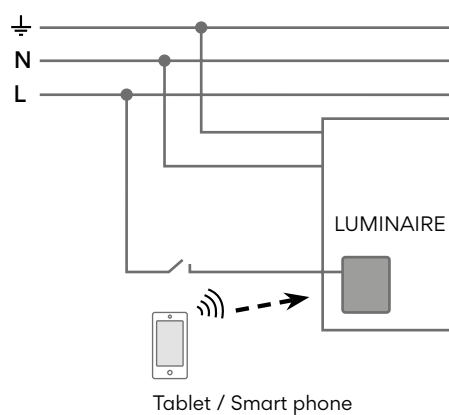

5 TRIAC control

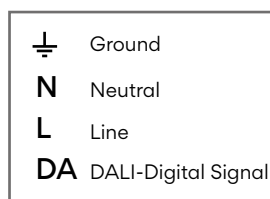
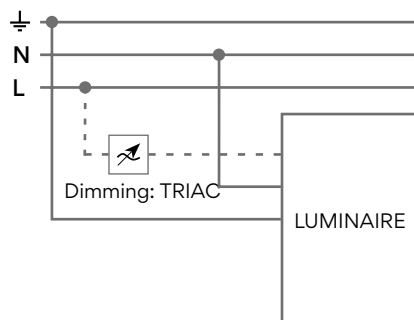

Very important

Vibia Lighting S.L.U. has the right to change any model or finish of the products included in the picture catalogue without any previous notice.

Vibia Lighting, S.L.U.

Office

Progrés 4-6.

08850 Gavà (Barcelona).

International Tel +34 934 796 971.

customer.service@vibia.com

vibia.com

COPYRIGHT© VIBIA LIGHTING S.L.U. ALL RIGHTS RESERVED.

